



SAKETH EXIM LIMITED

U29253MH2010PLC204331

Our Company was incorporated as Saketh Exim Private Limited on June 16, 2010 under the Companies Act, 1956 with the Registrar of Companies, Mumbai bearing Registration No. 204331. Subsequently, the status of our Company was changed to a public limited company and the name of our Company was changed to Saketh Exim Limited vide Special Resolution dated December 07, 2017. A fresh certificate of incorporation consequent upon conversion was granted to our Company on December 19, 2017, by the Registrar of Companies, Mumbai. The Corporate Identity Number of our Company is U29253MH2010PLC204331. For further details pertaining to the change of name of our Company and the change in Registered Office, please refer the chapter "History and Certain Corporate Matters" on page no. 124 of this Prospectus..

Registered Office: Plot No- PAP D-146/147, TTC MIDC, Turbhe, Navi Mumbai - 400 705

Tel No.: +91 22 2762 0641/42/43; **Fax No.:** +91 22 2762 0623; **Email:** info@sakethexim.com; **Website:** www.sakethexim.com

Contact Person: Ms. Neelam Pathak, Company Secretary and Compliance Officer

Our Promoters: Mr. Sanjay J Patel, Mrs. Smita S Patel, Mrs. Taruna P Patel and Mrs. Fatema S Kachwala

THE ISSUE

PUBLIC ISSUE OF 13,68,000 EQUITY SHARES OF ₹ 10/- EACH ("EQUITY SHARES") OF SAKETH EXIM LIMITED ("SEL" OR THE "COMPANY") FOR CASH AT A PRICE OF ₹ 69/- PER SHARE (THE "ISSUE PRICE"), AGGREGATING TO ₹ 943.92 LAKHS ("THE ISSUE") CONSISTING OF FRESH ISSUE OF 11,23,000 EQUITY SHARES AGGREGATING TO ₹ 774.87 LAKHS AND AN OFFER FOR SALE OF 2,45,000 EQUITY SHARES BY THE PROMOTER GROUP SELLING SHAREHOLDER AGGREGATING TO ₹ 169.05 LAKHS ("OFFER FOR SALE"), OF WHICH 72,000 EQUITY SHARES OF FACE VALUE OF ₹ 10 EACH WILL BE RESERVED FOR SUBSCRIPTION BY MARKET MAKER TO THE ISSUE (THE "MARKET MAKER RESERVATION PORTION"). THE ISSUE LESS MARKET MAKER RESERVATION PORTION I.E. ISSUE OF 12,96,000 EQUITY SHARES OF FACE VALUE OF ₹ 10/- EACH IS HERINAFTER REFERRED TO AS THE "NET ISSUE". THE ISSUE AND THE NET ISSUE WILL CONSTITUTE 27.23% AND 25.80% RESPECTIVELY OF THE POST ISSUE PAID UP EQUITY SHARE CAPITAL OF THE COMPANY.

THE FACE VALUE OF THE EQUITY SHARE IS ₹ 10 AND THE ISSUE PRICE IS 6.90 TIMES OF THE FACE VALUE

THIS ISSUE IS BEING MADE IN TERMS OF CHAPTER XB OF THE SEBI (ICDR) REGULATIONS, 2009 AS AMENDED FROM TIME TO TIME.

For further details see "Issue Related Information" beginning on page no.216 of this Prospectus.

In terms of the SEBI Circular No. CIR/CFD/POLICYCELL/11/2015, all potential investors shall participate in the Issue only through an Application Supported by Blocked Amount ("ASBA") process providing details about the bank account which will be blocked by the Self Certified Syndicate Banks ("SCSBs") for the same. For details in this regard, specific attention is invited to "Issue Procedure" on page no. 225 of this Prospectus. A copy will be delivered for registration to the Registrar of Companies as required under Section 26 and 28 of the Companies Act, 2013.

RISK IN RELATION TO THE FIRST ISSUE

This being the first public issue of the Company, there has been no formal market for the securities of the Company. The face value of the shares is ₹ 10/- per Equity Share and the Issue Price is 6.90 times of the face value. The Issue Price (as determined by Company and the Selling Shareholder in consultation with the Lead Manager) as stated under the paragraph on "Basis for Issue Price" on page no. 78 of this Prospectus should not be taken to be indicative of the market price of the Equity Shares after the Equity Shares are listed. No assurance can be given regarding an active or sustained trading in the equity shares of our company or regarding the price at which the shares will be traded after listing.

GENERAL RISKS

Investment in equity and equity related securities involve a degree of risk and investors should not invest any funds in this issue unless they can afford to take the risk of losing their investment. Investors are advised to read the risk factors carefully before taking an investment decision in this Issue. For taking an investment decision investors must rely on their own examination of our Company and the Issue including the risks involved. The securities have not been recommended or approved by Securities and Exchange Board of India nor does Securities and Exchange Board of India guarantee the accuracy or adequacy of this document. **Specific attention of the Investors is invited to the section titled "Risk Factors" on page no. 15 of this Prospectus.**

COMPANY'S AND SELLING SHAREHOLDERS' ABSOLUTE RESPONSIBILITY

Our Company, having made all reasonable inquiries, accepts responsibility for and confirms that this Prospectus contains all information with regard to our Company and the Issue, which is material in the context of the Issue, that the information contained in this Prospectus is true and correct in all material aspects and is not misleading in any material respect, that the opinions and intentions expressed herein are honestly held and that there are no other facts, the omission of which makes this Prospectus as a whole or any of such information or the expression of any such opinions or intentions misleading in any material respect. The Selling Shareholder assumes responsibility only for statements in relation to the Selling Shareholder included in this Prospectus.

LISTING

The Equity Shares offered through this Prospectus are proposed to be listed on the EMERGE Platform of National Stock Exchange of India Limited ("NSE"). Our Company has received an In-principle Approval letter dated May 18, 2018 from NSE for listing our shares on the EMERGE Platform of the NSE. For the purpose of this Issue, the Designated Stock Exchange will be the National Stock Exchange of India Limited ("NSE").

LEAD MANAGER TO THE ISSUE

REGISTRAR TO THE ISSUE



ARYAMAN FINANCIAL SERVICES LIMITED

60, Khatau Building, Ground Floor

Alkesh Dinesh Modi Marg, Fort, Mumbai – 400 001

Tel No.: +91 22 6216 6999

Fax No.: +91 22 2263 0434

Email: ipo@afsl.co.in

Website: www.afsl.co.in

Investor Grievance Email: feedback@afsl.co.in

Contact Person: Mrs. Jyothi Shetty / Ms. Hiral Motani

SEBI Registration No.: INM000011344



BIGSHARE SERVICES PRIVATE LIMITED

1st Floor, Bharat Tin Works Building, Opp. Vasant Oasis

Makwana Road, Marol, Andheri (East), Mumbai – 400 059

Tel No.: +91 22 6263 8200

Fax No.: +91 22 6263 8299

Email: ipo@bigshareonline.com

Website: www.bigshareonline.com

Investor Grievance Email: investor@bigshareonline.com

Contact Person: Mr. Jibu John

SEBI Registration No.: INR000001385

ISSUE OPENS ON

AUGUST 01, 2018

ISSUE CLOSES ON

AUGUST 03, 2018

Table of Contents

SECTION I – GENERAL	3
DEFINITION AND ABBREVIATION.....	3
CERTAIN CONVENTIONS; PRESENTATION OF FINANCIAL, INDUSTRY AND MARKET DATA.....	11
FORWARD-LOOKING STATEMENTS.....	13
SECTION II – RISK FACTORS	15
SECTION III – INTRODUCTION	36
SUMMARY OF INDUSTRY	36
SUMMARY OF OUR BUSINESS	44
SUMMARY OF FINANCIAL INFORMATION.....	48
THE ISSUE.....	51
GENERAL INFORMATION	52
CAPITAL STRUCTURE.....	60
SECTION IV – PARTICULARS OF THE ISSUE	71
OBJECTS OF THE ISSUE	71
BASIC TERMS OF THE ISSUE.....	76
BASIS FOR ISSUE PRICE	78
STATEMENT OF TAX BENEFITS	80
SECTION V – ABOUT THE ISSUER COMPANY	83
INDUSTRY OVERVIEW	83
OUR BUSINESS	96
KEY REGULATIONS AND POLICIES.....	115
HISTORY AND CERTAIN CORPORATE MATTERS	124
OUR MANAGEMENT.....	128
OUR PROMOTERS AND PROMOTER GROUP.....	142
OUR GROUP COMPANY	146
CURRENCY, UNITS OF PRESENTATION AND EXCHANGE RATES.....	149
DIVIDEND POLICY	150
SECTION VI – FINANCIAL INFORMATION	151
FINANCIAL STATEMENTS	151
MANAGEMENT’S DISCUSSION AND ANALYSIS OF FINANCIAL CONDITION AND RESULTS OF OPERATIONS.....	174
FINANCIAL INDEBTEDNESS.....	188
SECTION VII – LEGAL AND OTHER INFORMATION	191
OUTSTANDING LITIGATION AND MATERIAL DEVELOPMENTS.....	191
GOVERNMENT AND OTHER KEY APPROVALS.....	197
SECTION VIII – OTHER REGULATORY AND STATUTORY DISCLOSURES	202
SECTION IX – ISSUE RELATED INFORMATION	216
TERMS OF THE ISSUE.....	216
ISSUE STRUCTURE	222
ISSUE PROCEDURE	225
RESTRICTIONS ON FOREIGN OWNERSHIP OF INDIAN SECURITIES.....	277
SECTION X – MAIN PROVISION OF ARTICLES OF ASSOCIATION	278
SECTION XI – OTHER INFORMATION	295
MATERIAL CONTRACTS AND DOCUMENTS FOR INSPECTION	295
DECLARATION	297



SECTION I – GENERAL

DEFINITION AND ABBREVIATION

General Terms

Term	Description
Saketh Exim Limited/ SEL / The Company / Company / We / Us / Our Company	Unless the context otherwise indicates or implies refers to Saketh Exim Limited, a public limited company incorporated under the provisions of the Companies Act, 1956 with its registered office in the Mumbai, Maharashtra.
Promoter(s)	The Promoters of our company are: <ul style="list-style-type: none"> • Mr. Sanjay J Patel • Mrs. Smita S Patel • Mrs. Taruna P Patel • Mrs. Fatema S Kachwala
Promoter Group	Such persons, entities and companies constituting our promoter group pursuant to Regulation 2(1)(zb) of the SEBI ICDR Regulations as disclosed in the Chapter titled “ <i>Our Promoter and Promoter Group</i> ” on page no. 142 of this Prospectus.

Company Related Terms

Term	Description
Articles /Articles of Association	Unless the context otherwise requires, refers to the Articles of Association of Saketh Exim Limited.
Auditor of the Company (Statutory Auditor/Peer Review Auditor)	M/s. R A Maru & Associates, Chartered Accountants, having their office at C/4, Khandwala Apartments CHSL, Vakola Pipe Line, Gaodevi, Santacruz (East), Mumbai - 400 055
Audit Committee	The committee of the Board of Directors constituted on December 26, 2017 as our Company’s Audit Committee in accordance with Section 177 of the Companies Act, 2013
Board of Directors / Board	The Board of Directors of Saketh Exim Limited, including all duly constituted Committees thereof.
Company Secretary and Compliance Officer	Ms. Neelam Pathak
Director(s)	Director(s) of Saketh Exim Limited, unless otherwise specified
Equity Shares	Equity Shares of our Company of Face Value of ₹ 10/- each unless otherwise specified in the context thereof
Equity Shareholders	Persons holding Equity Share of our Company
Group Companies	Tembo Exim Private Limited. For details please refer chapter titled “ <i>Our Group Company</i> ” page no. 146 of this Prospectus
Key Management Personnel / KMP	Individuals described in the chapter titled “ <i>Our Management</i> ” on page no. 128 of this Prospectus
MOA / Memorandum of Association	Memorandum of Association of Saketh Exim Limited
Nomination and Remuneration Committee	The committee of the Board of Directors constituted on December 26, 2017 as our Company’s Nomination and Remuneration Committee in accordance with Section 178 of the Companies Act, 2013
Registered Office	The Registered Office of our company which is located at Plot No - Pap D- 146/ 147, TTC MIDC, Turbhe, Navi Mumbai - 400 705
Registrar of Companies /	Registrar of Companies, Mumbai situated at Everest, 100, Marine Drive, Mumbai –



Term	Description
RoC	400 002
Restated Financial Statements	The restated financial statements of our Company for the Financial Years ended March 31, 2018, 2017, 2016, 2015 and 2014, which comprises the restated balance sheet, the restated statement of profit and loss and the restated cash flow statement, together with the annexures and notes thereto, which have been prepared in accordance with the Companies Act, Indian GAAP, and restated in accordance with the SEBI ICDR Regulations.
Stakeholders' Relationship Committee	The committee of the Board of Directors constituted on December 26, 2017 as our Company's Stakeholders' Relationship Committee with Section 178 of the Companies Act, 2013
Stock Exchange	Unless the context requires otherwise, refers to, the EMERGE Platform of National Stock Exchange of India Limited.

Issue Related Terms

Term	Description
Abridged Prospectus	Abridged Prospectus to be issued under Regulation 58 of SEBI ICDR Regulations and appended to the Application Form
Allotment	Unless the context otherwise requires, the allotment of the Equity Shares pursuant to the Issue to the successful Applicants, including transfer of the Equity Shares pursuant to the Issue to the successful applicants
Allotment Advice	Note, advice or intimation of Allotment sent to the Applicants who have been or are to be Allotted the Equity Shares after the Basis of Allotment has been approved by the Designated Stock Exchange
Allottee(s)	The successful applicant to whom the Equity Shares are being / have been Allotted.
Applicant	Any prospective investor who makes an application for Equity Shares in terms of this Prospectus
Application Form	The Form in terms of which the applicant shall apply for the Equity Shares of the Company
Application Supported by Blocked Amount/ ASBA	An application, whether physical or electronic, used by ASBA Applicant to make an Application authorizing an SCSB to block the Application Amount in the specified Bank Account maintained with such SCSB. ASBA is mandatory for all Applicants participating in the Issue.
ASBA Account	A bank account maintained with an SCSB and specified in the ASBA Form submitted by the Applicants for blocking the Application Amount mentioned in the ASBA Form.
ASBA Applicant(s)	Any prospective investor who makes an Application pursuant to the terms of the Prospectus and the Application Form.
ASBA Application / Application	An indication to make an Issue during the Issue Period by an Applicant pursuant to submission of the Application Form, to subscribe to the Equity Shares at a price as mentioned in the Prospectus, including all revisions and modifications thereto as permitted under the SEBI ICDR Regulations in terms of the Prospectus and Application Form
Banker(s) to the Company	Such banks which are disclosed as Bankers to our Company in the chapter titled "General Information" on page no. 52 of this Prospectus.
Banker(s) to the Issue	The banks which are Clearing Members and registered with SEBI as Banker to an Issue with whom the Escrow Agreement is entered and in this case being Axis Bank Limited.
Basis of Allotment	The basis on which the Equity Shares will be Allotted to successful Applicants under the Issue and which is described in the chapter titled "Issue Procedure" beginning on page no. 225 of this Prospectus.
Business Day	Monday to Friday (except public holidays)
CAN / Confirmation of Allocation Note	The note or advice or intimation sent to each successful Applicant indicating the Equity Shares which will be Allotted, after approval of Basis of Allotment by the Designated



Term	Description
	Stock Exchange.
Collecting Depository Participant(s) or CDP(s)	A depository participant as defined under the Depositories Act, 1996, registered with SEBI and who is eligible to procure Applications at the Designated CDP Locations in terms of circular No. GR/CFD/POLICYCELL/11/2015 dated November 10, 2015 issued by SEBI
Controlling Branches	Such Branches of the SCSBs which co-ordinate Applications by the Applicants with the Registrar to the Issue and the Stock Exchanges and a list of which is available at http://www.sebi.gov.in or at such other website as may be prescribed by SEBI from time to time.
Demographic Details	The demographic details of the Applicants such as their Address, PAN, Occupation and Bank Account details.
Depositories	A depository registered with SEBI under the SEBI (Depositories and Participant) Regulations, 1996 i.e. CDSL and NSDL
Depositories Act	The Depositories Act, 1996, as amended from time to time
Designated Date	The date on which the funds blocked by the SCSBs are transferred from the ASBA Accounts specified by the Applicants to the Public Issue Account.
Designated Intermediaries / Collecting Agent	Syndicate Members, Sub-Syndicate/Agents, SCSBs, Registered Brokers, Brokers, the CDPs and RTAs, who are authorized to collect Application Forms from the Applicants, in relation to the Issue
Designated CDP Locations	Such locations of the CDPs where Applicants can submit the Application Forms to Collecting Depository Participants. The details of such Designated CDP Locations, along with names and contact details of the Collecting Depository Participants eligible to accept Application Forms are available on the websites of the Stock Exchange
Designated RTA Locations	Such locations of the RTAs where Applicants can submit the Application Forms to RTAs. The details of such Designated RTA Locations, along with names and contact details of the RTAs eligible to accept Application Forms are available on the websites of the Stock Exchange
Designated Market Maker	Aryaman Capital Markets Limited (formerly known as Aryaman Broking Limited) will act as the Market Maker and has agreed to receive or deliver the specified securities in the market making process for a period of three years from the date of listing of our Equity Shares or for a period as may be notified by amendment to SEBI ICDR Regulations
Designated SCSB Branches	Such Branches of the SCSBs which shall collect the Application Forms used by the Applicants applying through the ASBA process and a list of which is available on http://www.sebi.gov.in/pmd/scsb.pdf
Designated Stock Exchange	EMERGE Platform of National Stock Exchange of India Limited
Draft Prospectus	The Draft Prospectus dated March 26, 2018 issued in accordance with the SEBI ICDR Regulations
Eligible NRIs	An NRI from such a jurisdiction outside India where it is not unlawful to make an Issue or invitation under this Issue and in relation to whom the Application Form and the Prospectus will constitute an invitation to purchase the Equity Shares.
EMERGE Platform of NSE	EMERGE Platform of National Stock Exchange of India Limited, approved by SEBI as an SME Exchange for listing of equity shares Offered under Chapter XB of the SEBI ICDR Regulations.
Escrow Agreement	Agreement entered into amongst the Company, the Lead Manager, the Selling Shareholders, the Registrar and the Banker to the Issue to receive monies from the Applicants through the SCSBs Bank Account on the Designated Date in the Public Issue Account.
Foreign Portfolio Investor / FPIs	Foreign Portfolio Investor as defined under the SEBI (Foreign Portfolio Investors) Regulations, 2014.
Fresh Issue	The fresh issue of 11,23,000 Equity Shares by our Company of ₹ 10 each aggregating to



Term	Description
	₹ 774.87 lakhs, to be issued by our Company for subscription pursuant to the terms of this Prospectus
Fresh Issue Proceeds	Gross proceeds to be raised through the Fresh Issue. For further details, please refer the chapter “ <i>Objects of the Issue</i> ” on page no. 71 of this Prospectus
Issue / Issue Size / Public Issue / IPO	This Initial Public Issue of 13,68,000 Equity Shares of ₹ 10 each for cash at a price of ₹ 69/- per equity share, aggregating to ₹ 943.92 lakhs by the Company and the Selling Shareholder.
Issue Closing date	The date on which the Issue closes for subscription being August 01, 2018
Issue Opening date	The date on which the Issue opens for subscription being August 03, 2018
Issue Price	The price at which the Equity Shares are being issued by our Company and the Selling Shareholder in consultation with the Lead Manager, under this Prospectus being ₹ 69/-.
LM / Lead Manager	Lead Manager to the Issue, in this case being Aryaman Financial Services Limited.
Listing Agreement / Equity Listing Agreement	Unless the context specifies otherwise, this means the Equity Listing Agreement to be signed between our Company and the EMERGE Platform of National Stock Exchange of India Limited.
Market Maker Reservation Portion	The reserved portion of 72,000 Equity Shares of ₹ 10 each at ₹ 69/- per Equity Share aggregating to ₹ 49.68 lakhs for the Designated Market Maker in the Public Issue of our Company.
Market Making Agreement	The Agreement among the Market Maker, the Lead Manager and our Company dated March 22, 2018 and addendum dated June 12, 2018.
Mutual Fund	A Mutual Fund registered with SEBI under the SEBI (Mutual Funds) Regulations, 1996, as amended
Non-Institutional Applicant	All Applicants, including Eligible QFIs, sub accounts of FIIs registered with SEBI which are foreign corporate or foreign individuals, that are not QIBs or Retail Individual Applicants and who have applied for Equity Shares for an amount of more than ₹ 2,00,000 (but not including NRIs other than Eligible NRIs)
Net Issue	The Net Issue of 12,96,000 Equity Shares of ₹ 10 each at ₹ 69/- per Equity Share aggregating to ₹ 894.24 lakhs by the Company and the Selling Shareholder.
Non-Resident	A person resident outside India, as defined under FEMA and includes Eligible NRIs, Eligible QFIs, FIIs registered with SEBI and FVCIs registered with SEBI
NSE	National Stock Exchange of India Limited
Person or Persons	Any individual, sole proprietorship, unincorporated association, unincorporated organization, body corporate, corporation, Company, partnership, limited liability Company, joint venture, or trust or any other entity or organization validly constituted and/or incorporated in the jurisdiction in which it exists and operates, as the context requires.
Prospectus	The Prospectus, filed with the RoC containing, inter alia, the Issue opening and closing dates and other information.
Public Issue Account	Account opened with Bankers to the Issue for the purpose of transfer of monies from the SCSBs from the ASBA accounts on the Designated Date.
Qualified Foreign Investors / QFIs	Non-resident investors other than SEBI registered FIIs or sub-accounts or SEBI registered FVCIs who meet ‘know your client’ requirements prescribed by SEBI
Qualified Institutional Buyers / QIBs	Public financial institutions as defined in Section 2(72) of the Companies Act, 2013, Foreign Portfolio Investor other than Category III Foreign Portfolio Investor, AIFs, VCFs, FVCIs, Mutual Funds, multilateral and bilateral financial institutions, scheduled commercial banks, state industrial development corporations, insurance companies registered with the IRDA, provident funds and pension funds with a minimum corpus of ₹ 250 million, insurance funds set up and managed by the army, navy or air force of the Union of India and insurance funds set up and managed by the Department of Posts, Government of India, eligible for Bidding and does not include FVCIs and multilateral and bilateral institutions.



Term	Description
Registrar and Share Transfer Agents/RTAs	Registrar and Share Transfer Agents registered with SEBI and eligible to procure Applications at the Designated RTA Locations in terms of circular No. CIR/CFD/POLICYCELL/11/2015 dated November 10, 2015 issued by SEBI
Registrar / Registrar to the Issue	Registrar to the Issue being Bigshare Services Private Limited
Retail Individual Investors	Individual investors (including HUFs, in the name of Karta and Eligible NRIs) who apply for the Equity Shares of a value of not more than ₹ 2,00,000
Self Certified Syndicate Bank(s) / SCSBs	A Bank registered with SEBI under the SEBI (Bankers to an Issue) Regulations, 1994 and Issues the facility of ASBA, including blocking of bank account. A list of all SCSBs is available at http://www.sebi.gov.in/pmd/scsb.pdf
Promoter Group Selling Shareholder	Mr. Piyush J Patel
Share Escrow Agent	Share Escrow agent appointed pursuant to the Share Escrow Agreement, being Bigshare Services Private Limited
Share Escrow Agreement	Agreement dated June 07, 2018 entered into between the Selling Shareholder, our Company, the Escrow Agent and the Lead Manager in connection with the transfer of Equity Shares under the Offer for Sale by the Selling Shareholder and credit of such Equity Shares to the demat account of the Allottees.
TRS / Transaction Registration Slip	The slip or document issued by a member of the Syndicate or an SCSB (only on demand), as the case may be, to the Applicant, as proof of registration of the Application.
Underwriters	Aryaman Financial Services Limited and Aryaman Capital Markets Limited.
Underwriting Agreement	The Agreement among the Underwriters, the Selling Shareholders and our Company dated March 22, 2018 and addendum dated June 12, 2018.
U.S. Securities Act	U.S. Securities Act of 1933, as amended
Working Day	All trading days of the Stock Exchange excluding Sundays and Bank holidays in Mumbai.

Technical / Industry related Terms

Term	Description
BF	Blast Furnace
CSO	Central Statistics Organisation
DRI	Direct Reduced Iron
FM	Factory Mutual/ Factory Mutation
G.I. Nuts	Glycaemic Index Nuts
HVAC	Heating, Ventilation and Air Conditioning
IAF	International Accreditation Forum
IIP	Index of Industrial Production
IMF	International Monetary Fund
ISP	Integrated Steel Producers
JAS-ANZ	Joint Accreditation System of Australia and New Zealand
KVIC	Khadi and Village Industries Commission
MPCB	Maharashtra Pollution Control Board
M.S. Rod/ M.S. Strips	Mild Steel Rod/ Mild Steel Strips
MSTC	Metal Scrap Trade Corporation
MT	Million Tonnes
NSP	National Steel Policy
OEM	Original Equipment Manufacturer
SRTMI	Steel Research and Technology Mission of India
S.S. Floor Drains	Stainless Steel Floor Drains



Term	Description
TMR	Transparency Market Research
UL	Underwriters Laboratories
WEO	World Economic Outlook

Conventional Terms / General Terms / Abbreviations

Term	Description
A/c	Account
AGM	Annual General Meeting
AIF	Alternative Investment Fund as defined in and registered with SEBI under the Securities and Exchange Board of India (Alternative Investments Funds) Regulations, 2012
AS / Accounting Standards	Accounting Standards as issued by the Institute of Chartered Accountants of India
ASBA	Applications Supported by Blocked Amount
AY	Assessment Year
CAGR	Compounded Annual Growth Rate
Category II foreign portfolio investor(s) / Category II FPIs	FPIs who are registered as “Category II foreign portfolio investors” under the SEBI FPI Regulations
Category III foreign portfolio investor(s) / Category III FPIs	FPIs who are registered as “Category III foreign portfolio investors” under the SEBI FPI Regulations
CDSL	Central Depository Services (India) Limited
CFO	Chief Financial Officer
CIN	Company Identification Number
CIT	Commissioner of Income Tax
Client ID	Client identification number of the Applicant’s beneficiary account
Companies Act	Unless specified otherwise, this would imply to the provisions of the Companies Act, 2013 (to the extent notified) and /or Provisions of Companies Act, 1956 w.r.t. the sections which have not yet been replaced by the Companies Act, 2013 through any official notification.
Companies Act, 1956	The Companies Act, 1956, as amended from time to time
Companies Act, 2013	The Companies Act, 2013 published on August 29, 2013 and applicable to the extent notified by MCA till date.
CSR	Corporate Social Responsibility
CST	Central Sales Tax
DIN	Director Identification Number
DP	Depository Participant as defined under the Depositories Act
DP ID	Depository Participant’s identification
ECS	Electronic Clearing System
EOGM	Extraordinary General Meeting
EMDEs	Emerging Market and Developing Economies
EPS	Earnings Per Share
FCNR Account	Foreign Currency Non Resident Account
FDI	Foreign Direct Investment
FEMA	Foreign Exchange Management Act, 1999, as amended from time to time, and the regulations framed there under
FIIIs	Foreign Institutional Investors (as defined under Foreign Exchange Management (Transfer or Issue of Security by a Person Resident outside India) Regulations, 2000) registered with SEBI under applicable laws in India



Term	Description
FPIs	Foreign Portfolio Investors as defined under the SEBI FPI Regulations
FIPB	Foreign Investment Promotion Board
FY / Fiscal / Financial Year	Period of twelve months ended March 31 of that particular year, unless otherwise stated
GDP	Gross Domestic Product
GoI/Government	Government of India
GST	Goods & Services Tax
HNI	High Networth Individuals
HUF	Hindu Undivided Family
IAS Rules	Indian Accounting Standards, Rules 2015
IFRS	International Financial Reporting Standards
Indian GAAP	Generally Accepted Accounting Principles in India
Ind AS	Indian Accounting Standards prescribed under section 133 of the Companies Act, 2013, as notified under the Companies (Indian Accounting Standard) Rules, 2015
I.T. Act	Income Tax Act, 1961, as amended from time to time
ICSI	Institute of Company Secretaries Of India
IPO	Initial Public Offering
ISIN	International Securities Identification Number
ISO	International Organization for Standardization
KM / Km / km	Kilo Meter
LLP	Limited Liability Partnership
Merchant Banker	Merchant Banker as defined under the Securities and Exchange Board of India (Merchant Bankers) Regulations, 1992
MoF	Ministry of Finance, Government of India
MICR	Magnetic ink character recognition
MOU	Memorandum of Understanding
NA / N. A.	Not Applicable
NAV	Net Asset Value
NECS	National Electronic Clearing Service
NEFT	National Electronic Fund Transfer
NoC	No Objection Certificate
NRE Account	Non Resident External Account
NRI	A person resident outside India, who is a citizen of India or a person of Indian origin, and shall have the meaning ascribed to such term in the Foreign Exchange Management (Deposit) Regulations, 2000
NRO Account	Non Resident Ordinary Account
NSDL	National Securities Depository Limited
NSE	National Stock Exchange of India Limited
OCB / Overseas Corporate Body	A company, partnership, society or other corporate body owned directly or indirectly to the extent of at least 60.00% by NRIs including overseas trusts, in which not less than 60.00% of beneficial interest is irrevocably held by NRIs directly or indirectly and which was in existence on October 3, 2003 and immediately before such date had taken benefits under the general permission granted to OCBs under FEMA
p.a.	per annum
P/E Ratio	Price/Earnings Ratio
PAC	Persons Acting in Concert
PAN	Permanent Account Number
PAT	Profit After Tax
PLR	Prime Lending Rate
RBI	The Reserve Bank of India
ROE	Return on Equity



Term	Description
RONW	Return on Net Worth
Rupees / Rs./ ₹	Rupees, the official currency of the Republic of India
RTGS	Real Time Gross Settlement
SCRA	Securities Contract (Regulation) Act, 1956, as amended from time to time
SCRR	Securities Contracts (Regulation) Rules, 1957, as amended from time to time
SEBI	Securities and Exchange Board of India
SEBI Act	Securities and Exchange Board of India Act, 1992
SEBI AIF Regulations	Securities and Exchange Board of India (Alternative Investments Funds) Regulations, 2012
SEBI FII Regulations	Securities and Exchange Board of India (Foreign Institutional Investors) Regulations, 1995
SEBI FPI Regulations	Securities and Exchange Board of India (Foreign Portfolio Investors) Regulations, 2014
SEBI FVCI Regulations	Securities and Exchange Board of India (Foreign Venture Capital Investor) Regulations, 2000
SEBI ICDR Regulations	Securities and Exchange Board of India (Issue of Capital and Disclosure Requirements) Regulations, 2009
SEBI LODR Regulations, 2015 / SEBI Listing Regulations	Securities and Exchange Board of India (Listing Obligations and Disclosure Requirements) Regulations, 2015 notified on September 2, 2015
SEBI SAST Regulations	Securities and Exchange Board of India (Substantial Acquisition of Shares and Takeovers) Regulations, 2011
Sec.	Section
Securities Act	U.S. Securities Act of 1933, as amended
SICA	Sick Industrial Companies (Special Provisions) Act, 1985
STT	Securities Transaction Tax
TIN	Taxpayers Identification Number
TDS	Tax Deducted at Source
US/United States	United States of America
USD/ US\$/ \$	United States Dollar, the official currency of the United States of America
VAT	Value added tax
VCF / Venture Capital Fund	Foreign Venture Capital Funds (as defined under the Securities and Exchange Board of India (Venture Capital Funds) Regulations, 1996) registered with SEBI under applicable laws in India.



CERTAIN CONVENTIONS; PRESENTATION OF FINANCIAL, INDUSTRY AND MARKET DATA

Certain Conventions

All references to “India” contained in this Prospectus are to the Republic of India. In this Prospectus, our Company has presented numerical information in “lakhs” units. One lakh represents 1,00,000.

Financial Data

Unless stated otherwise, the financial data in this Prospectus is derived from our audited financial statements as on Fiscal Years ended March 31, 2018, 2017, 2016, 2015 and 2014, prepared in accordance with Indian GAAP and the Companies Act and restated in accordance with the SEBI Regulations and included in this Prospectus. Our Fiscal Year commences on April 1 and ends on March 31 of the following year. In this Prospectus, any discrepancies in any table, graphs or charts between the total and the sums of the amounts listed are due to rounding-off.

There are significant differences between Indian GAAP, U.S. GAAP and IFRS. Accordingly, the degree to which the Indian GAAP financial statements included in this Prospectus will provide meaningful information is entirely dependent on the reader’s level of familiarity with Indian accounting practices. Any reliance by persons not familiar with Indian accounting practices, Indian GAAP, the Companies Act and the SEBI Regulations on the financial disclosures presented in this Prospectus should accordingly be limited. We have not attempted to explain the differences between Indian GAAP, U.S. GAAP and IFRS or quantify their impact on the financial data included herein, and we urge you to consult your own advisors regarding such differences and their impact on our financial data.

Any percentage amounts, as set forth in the section titled “*Risk Factors*”, chapters titled “*Our Business*” and “*Management’s Discussion and Analysis of Financial Condition and Results of Operations*” beginning on page nos. 15, 96 and 174 of this Prospectus, respectively, and elsewhere in this Prospectus, unless otherwise indicated, have been calculated on the basis of our audited financial statements prepared in accordance with Indian GAAP and the Companies Act and restated in accordance with the SEBI Regulations.

Currency, Units of Presentation and Exchange Rates

All references to “Rupees”, “Rs.” or “₹” are to Indian Rupees, the official currency of the Republic of India. All references to “US\$” or “US Dollars” or “USD” are to United States Dollars, the official currency of the United States of America.

This Prospectus may contain conversions of certain US Dollar and other currency amounts into Indian Rupees that have been presented solely to comply with the requirements of the SEBI Regulations. These conversions should not be construed as a representation that those US Dollar or other currency amounts could have been, or can be converted into Indian Rupees, at any particular rate.

Definitions

For definitions, for details please see the Chapter titled “*Definitions and Abbreviations*” on page no. 3 of this Prospectus in the Section titled “*Main Provisions of the Articles of Association of our Company*” beginning on page no. 278 of this Prospectus, defined terms have the meaning given to such terms in the Articles of Association.

Industry and Market Data

Unless stated otherwise, the industry and market data and forecasts used throughout this Prospectus has been obtained from industry sources as well as Government Publications. Industry sources as well as Government Publications generally state that the information contained in those publications has been obtained from sources



believed to be reliable but that their accuracy and completeness and underlying assumptions are not guaranteed and their reliability cannot be assured.

Further, the extent to which the industry and market data presented in this Prospectus is meaningful depends on the reader's familiarity with and understanding of the methodologies used in compiling such data. There are standard data gathering methodologies in the industry in which we conduct our business and methodologies and assumptions may vary widely among different industry sources.



FORWARD-LOOKING STATEMENTS

All statements contained in this Prospectus that are not statements of historical fact constitute forward-looking statements. All statements regarding our expected financial condition and results of operations, business, plans and prospects are forward-looking statements. These forward-looking statements include statements with respect to our business strategy, our revenue and profitability, our projects and other matters discussed in this Prospectus regarding matters that are not historical facts. Investors can generally identify forward-looking statements by the use of terminology such as “aim”, “anticipate”, “believe”, “expect”, “estimate”, “intend”, “objective”, “plan”, “project”, “may”, “will”, “will continue”, “will pursue”, “contemplate”, “future”, “goal”, “propose”, “will likely result”, “will seek to” or other words or phrases of similar import. All forward looking statements (whether made by us or any third party) are predictions and are subject to risks, uncertainties and assumptions about us that could cause actual results to differ materially from those contemplated by the relevant forward-looking statement.

Forward-looking statements reflect our current views with respect to future events and are not a guarantee of future performance. These statements are based on our management’s beliefs and assumptions, which in turn are based on currently available information. Although we believe the assumptions upon which these forward-looking statements are based are reasonable, any of these assumptions could prove to be inaccurate, and the forward-looking statements based on these assumptions could be incorrect.

Further the actual results may differ materially from those suggested by the forward-looking statements due to risks or uncertainties associated with our expectations with respect to, but not limited to, regulatory changes pertaining to the pipe support hanger & related metal products as well as textile industry in India and overseas in which we have our businesses and our ability to respond to them, our ability to successfully implement our strategy, our growth and expansion, technological changes, our exposure to market risks, general economic and political conditions in India and overseas which have an impact on our business activities or investments, the monetary and fiscal policies of India and other jurisdictions in which we operate, inflation, deflation, unanticipated volatility in interest rates, foreign exchange rates, equity prices or other rates or prices, the performance of the financial markets in India and globally, changes in domestic laws, regulations and taxes, changes in competition in our industry and incidence of any natural calamities and/or acts of violence. Other important factors that could cause actual results to differ materially from our expectations include, but are not limited to, the following:

- General economic and business conditions in the markets in which we operate and in the local, regional and national economies
- Increasing competition in or other factors affecting the industry segments in which our Company operates
- Changes in laws and regulations relating to the industries in which we operate;
- Recession in the pipe support hanger & related metal products as well as textile industry / market in India or abroad
- Volatility of interest rates and inflation
- Our ability to successfully implement our growth strategy and expansion plans, and to successfully launch and implement various projects and business plans;
- Our ability to meet our capital expenditure requirements and/or increase in capital expenditure;
- Our inability to retain the services of our senior management, key managerial personnel and capable employees;
- Changes in political and social conditions in India the monetary policies of India and other countries, inflation, deflation, unanticipated turbulence in interest rates, equity prices or other rates or prices;
- Failure to obtain any applicable approvals, licenses, registrations and permits in a timely manner

For further discussions of factors that could cause our actual results to differ, please see the section titled “*Risk Factors*” and the chapters titled “*Our Business*” and “*Management’s Discussion and Analysis of Financial Condition and Results of Operations*” beginning on page nos. 15, 96 and 174 of this Prospectus, respectively.

By their nature, certain risk disclosures are only estimates and could be materially different from what actually occurs in the future. As a result, actual future gains or losses could materially differ from those that have been estimated. Forward-looking statements speak only as of this Prospectus. Our Company, the Selling Shareholder, our



Directors, the Lead Manager, and their respective affiliates or associates do not have any obligation to, and do not intend to, update or otherwise revise any statements reflecting circumstances arising after the date hereof or to reflect the occurrence of underlying events, even if the underlying assumptions do not come to fruition. In accordance with the SEBI requirements, our Company, the Selling Shareholder and the Lead Manager will ensure that investors in India are informed of material developments until such time as the grant of listing and trading approvals by the Stock Exchange.



SECTION II – RISK FACTORS

An investment in Equity Shares involves a high degree of financial risk. You should carefully consider all information in this Prospectus, including the risks described below, before making an investment in our Equity Shares. The risk factors set forth below do not purport to be complete or comprehensive in terms of all the risk factors that may arise in connection with our business or any decision to purchase, own or dispose of the Equity Shares. This section addresses general risks associated with the industry in which we operate and specific risks associated with our Company. Any of the following risks, as well as the other risks and uncertainties discussed in this Prospectus, could have a material adverse effect on our business and could cause the trading price of our Equity Shares to decline and you may lose all or part of your investment. In addition, the risks set out in this Prospectus are not exhaustive. Additional risks and uncertainties, whether known or unknown, may in the future have material adverse effect on our business, financial condition and results of operations, or which we currently deem immaterial, may arise or become material in the future. To obtain a complete understanding of our Company, prospective investors should read this section in conjunction with the sections entitled “Our Business” and “Management’s Discussion and Analysis of Financial Condition and Results of Operations” on page nos. 96 and 174 of this Prospectus respectively as well as other financial and statistical information contained in this Prospectus. Unless otherwise stated in the relevant risk factors set forth below, we are not in a position to specify or quantify the financial or other risks mentioned herein.

This Prospectus also contains forward-looking statements that involve risks and uncertainties. Our results could differ materially from those anticipated in these forward-looking statements as a result of certain factors, including events described below and elsewhere in this Prospectus. Unless otherwise stated, the financial information used in this section is derived from and should be read in conjunction with restated financial information of our Company prepared in accordance with the Companies Act and restated in accordance with the SEBI (ICDR) Regulations, including the schedules, annexure and notes thereto.

Materiality

The Risk factors have been determined on the basis of their materiality. The following factors have been considered for determining the materiality.

1. Some events may have material impact quantitatively;
2. Some events may have material impact qualitatively instead of quantitatively;
3. Some events may not be material individually but may be found material collectively;
4. Some events may not be material at present but may be having material impact in future.

INTERNAL RISK FACTORS

- 1. We require certain approvals and licenses in the ordinary course of business and are required to comply with certain rules and regulations to operate our business, and the failure to obtain, retain and renew such approvals and licences or comply with such rules and regulations, and the failure to obtain or retain them in a timely manner or at all may adversely affect our operations.***

We require several statutory and regulatory permits, licenses and approvals to operate our business, some of which our Company has either received, applied for or is in the process of application. Many of these approvals are granted for fixed periods of time and need renewal from time to time. Non-renewal of the said permits and licenses would adversely affect our Company’s operations, thereby having a material adverse effect on our business, results of operations and financial condition. There can be no assurance that the relevant authorities will issue any of such permits or approvals in the time-frame anticipated by us or at all.

Our Company is required to obtain the following approvals for our business but the same have not been obtained by us, as on date of this Prospectus: (i) Certificate of Registration under the Employees Provident Fund and Miscellaneous Provisions Act, 1952; and (ii) Certificate of Registration under the Employee State Insurance



Act, 1948. We may be penalized for non-compliance with the aforementioned laws for which we have not obtained the requisite Licenses/approvals.

Our Company has applied for the following approvals and the receipt of the same are pending as on date of this Prospectus: (i) Application for Factory License is made to the Chief Inspector of Factories in respect of the factory situated at Unit 3, APL House, Tungareashwar Industrial Estate, S. No. 1, Hissa No. 8, Sativali, Vasai-401208 and (ii) Application for Registration under Section 7 of the Contract Labour (Regulation and Abolition) Act, 1970 on December 15, 2017.

Further, some of our permits, licenses and approvals are subject to several conditions and we cannot provide any assurance that we will be able to continuously meet such conditions or be able to prove compliance with such conditions to the statutory authorities, which may lead to the cancellation, revocation or suspension of relevant permits, licenses or approvals. Any failure by us to apply in time, to renew, maintain or obtain the required permits, licenses or approvals, or the cancellation, suspension or revocation of any of the permits, licenses or approvals may result in the interruption of our operations and may have a material adverse effect on the business. If we fail to comply with all applicable regulations or if the regulations governing our business or their implementation change, we may incur increased costs, be subject to penalties or suffer a disruption in our business activities, any of which could adversely affect our results of operations. For further details, please see chapters titled “*Key Industry Regulations and Policies*” and “*Government and Other Statutory Approvals*” at page nos. 115 and 197 respectively of this Prospectus.

- 2. We are highly dependent on our suppliers for uninterrupted supply of raw-materials. We have not entered into any long term supply agreement for the major raw materials required for manufacturing of our products. Also volatility in the prices and non availability of these raw materials may have an adverse impact in our business prospects, results of operations and financial condition.***

We are highly dependent on M.S. Strips, M.S. Rods, Alloy steel, stainless steel and other hardware items and metal articles which are the prime raw material for our products. We procure our supply of raw materials from various vendors in the market. We have not entered into any long term supply agreement for supply of major raw materials.

Currently, we have been able to secure timely supply of required raw material for our existing activity. Raw material is easily available in the domestic market and no difficulty is envisaged in sourcing of the raw material. In case of any disruption in supply of raw materials from these suppliers or our procurement of raw materials in terms are not favourable to us; it will adversely affect our operations and financial cost. Further in case our Company is unable to procure the requisite quantities of raw materials well in time and at competitive prices due to volatility in the prices of raw materials, the performance of our company may be affected, thus adversely affecting our business, prospects, results of operations and financial condition.

- 3. We rely significantly on our agent networking in open market for local and export sale of our products.***

We sell our products in open market through our network of distributors and agents as well as through Direct Marketing. Our products are marketed through a wide network of distribution channel within Middle East countries and USA, UK etc. The Company is dependent on them for marketing and distribution. Accordingly, any shortcomings in the performance would impact the revenues and profitability of the Company. Further, as a means of direct marketing, we also conduct exhibition of our products in foreign countries. However, significant proportion of the sale is done through our agents in foreign countries.

Furthermore, our business growth depends on our ability to attract additional distributorships to our network. While, we believe that we have good relations with our distributors and agents but there is no assurance that our current distributors will continue to do business with us. If we do not succeed in maintaining the stability of our distributorship network, our market share may decline materially affecting our results of operations and financial condition.



4. Our Company has substantial requirement of working capital and failure to manage our working capital could have an adverse effect on our net sales, profitability, cash flow and liquidity.

We are engaged in manufacturing and fabrication of various steel products which are meant for its application in Pipe Support Systems, HVAC Systems, Anti-vibration System and Equipments for Industrial, Commercial, Utility and OEM Installations. We manufacture various engineering products, metal and base metal products like G. I. nuts, various types of bolts, clamps, hangers etc. Further our Product Portfolio includes all types of bathroom pipes, fittings, bathroom accessories and sanitary wares. Moreover, we are also engaged in trading of Textile Products. Our company business needs substantial working capital and financing in the form of fund and non-fund based working capital facilities to meet its requirements. A liquidity crunch may also result in increased working capital borrowings and consequently, higher finance cost which will adversely impact our profitability.

Generally, payments from clients are linked to completion of milestones. Payments are spread out over the execution period of the contracts. Consequently, there could be situation where the total funds available may not be sufficient to fulfil the commitments in which case additional funding can be raised through commercial borrowings, vendor financing or issue of fresh capital, in such event the interest obligation would increase and the company may be subject to additional covenants. Working capital is partially met through internal accruals. However, failure to manage our working capital requirements in the future could have an adverse effect on our net sales, profitability, cash flow and liquidity.

5. Our Company is subject to inspections under the Maharashtra Pollution Control Board and various other regulatory authorities, which may result in imposition of penalty on us.

Inspection proceedings are undertaken by various authorities for verifying the compliance of manufacturing and quality standards as per UL and FM approvals for meeting the worldwide recognition standards, and at various local levels like Maharashtra Pollution Control Board (MPCB) at regular intervals of our products that are fabricated and manufactured by us. Our Company is also subject to testing and audits by the respective authorities, for maintaining the quality parameters of the final product and also maintaining the hygienic conditions of the factory. Consequently, we may fail to adhere to the directions of the authorities in a timely manner which may attract penal sanctions affecting our operations and financial condition.

6. Our Company had availed ₹ 240.28 lakhs as unsecured loans from Promoters which are repayable on demand. Any demand from the lenders for repayment of such unsecured loan may affect our cash flow and financial condition. Also, such unsecured loans may be recalled at any time which may have an adverse effect on our business, prospects, financial condition and results of operations.

Our Company as per the restated audited financial statement as on March 31, 2018 had availed total sum of ₹ 240.28 lakhs as unsecured loan from Promoters which may be recalled at any time. Sudden recall for the repayment may disrupt our operations and also may force us to opt for funding at higher interest rates, resulting in higher financial burden.

Further, our Company will not be able to raise funds at short notice and thus result in shortage of working capital fund. For further details, please refer to the section “Unsecured Loans” under “Restated Financial Statements” beginning on page no. 151 of this Prospectus. Any demand for the repayment of such unsecured loan, may adversely affect our cash flow and financial condition.

Our Company may obtain in future, unsecured loans, some of which may be recalled at any time at the option of the lender. If the unsecured loans so obtained by our Company are recalled at any time, the financial condition of our Company may be adversely affected having an effect on our business, prospects and results of operations also.





7. Our Company has incurred substantial indebtedness which exposes us to various risks which may have an adverse effect on our business and results of operations.

As on March 31, 2018, we had ₹ 1,993.24 lakhs of outstanding debt on our balance sheet (including current maturities but excluding non-fund based) from various banks and financial institutions. In the event that we fail to meet our debt servicing obligations under our financing documents, the relevant lenders could declare us to be in default, accelerate the maturity of our obligations or takeover our project or even sell our Company's movable and immovable assets. We cannot assure investors that in the event of any such acceleration we will have sufficient resources to repay these borrowings. Failure to meet obligations under debt financing agreements may have an adverse effect on our cash flows, business and results of operations. Our ability to meet our debt service obligations and to repay our outstanding borrowings will depend primarily upon the cash flows generated by our business. We cannot assure you that we will generate sufficient cash to enable us to service existing or proposed borrowings. Incurring significant indebtedness may limit our flexibility in planning for or reacting to changes in our business & industry and limit our ability to borrow additional funds. Further, our level of indebtedness has important consequences to our Company, such as:

- Increasing our vulnerability to general adverse economic, industry and competitive conditions;
- Limiting our flexibility in planning for, or reacting to, changes in our business and the industry; affecting our credit rating;
- Limiting our ability to borrow more money both now and in the future; and
- Increasing our interest expenditure and adversely affecting our profitability, since almost all of our debt bears interest at floating rates.

If any of these risks were to materialise, our business and results of operations may be adversely affected.

8. Any infringement of our registered corporate logos “” and “TEMBO” or failure to protect it may adversely affect our business. Further, any kind of negative publicity or misuse of our brand name and our logo could hamper our brand building efforts and our future growth strategy could be adversely affected.

Our corporate logos “” and “TEMBO” are registered with the Registrar of Trademarks bearing Nos. 2268470 and 2102325. As on the date of this Prospectus, we have not yet obtained registration for our logo “



” and hence we do not enjoy the statutory protection accorded to a registered trademark. Additionally, we

have made an application for the registration of our logo “” before the Trade Marks Registry, India which is currently pending registration. However, there can be no assurance that our application will succeed. Grounds for refusal of registration may include the validity or scope of the application. If we are unable to obtain a registration, we may still continue to use the logo but remain vulnerable to infringement and passing-off by third parties and will not be able to enforce any rights against them. We may also need to change our logo which may adversely affect our reputation and business and could require us to incur additional costs.

We believe that our future growth and competitiveness would depend on our ability to establish and strengthen our brand. While 61.22% and 43.72% of our revenue from the manufacturing activities was attributed to our brand – “Tembo Seven Star” and “iETALiA”, during the Fiscal 2018 and 2017, respectively; we expect this share to increase in future.

Although, we believe that that our present systems are adequate to protect our confidential information and intellectual property, there can be no assurance that our intellectual property data, trade secrets or proprietary technology will not be copied, infringed or obtained by third parties. Further, our efforts to protect our intellectual property may not be adequate and may lead to erosion of our business value and our operations could be adversely affected. This may lead to litigations and any such litigations could be time consuming and



costly and their outcome cannot be guaranteed. Our Company may not be able to detect any unauthorized use or take appropriate and timely steps to enforce or protect our intellectual property, which may adversely affect our business, financial condition and results of operations. For further details pertaining to our intellectual property, please refer to the chapter titled “*Our Business*” beginning on page 96 of this Prospectus.

9. *Our Company has entered into certain related party transactions in the past and may continue to do so in the future, which may potentially involve conflicts of interest with the equity shareholders.*

Our Company has entered into certain transactions with our related parties including our Promoters, Promoter Group, Directors and their relatives. While we believe that all such transactions have been conducted on the arm’s length basis, we cannot assure you that we might have obtained more favourable terms had such transactions been entered into with unrelated parties.

Furthermore, it is likely that we may enter into related party transactions in the future. We cannot assure you that such transactions, individually or in the aggregate, will always be in the best interests of our minority shareholders and will not have an adverse effect on our business, results of operations, cash flows and financial condition. For details, please refer “*Annexure XXV – Related Party Transactions*” on page no. 169 of this Prospectus.

10. *Our Company might be unable to meet certain delivery obligations including timelines of delivery due to various reasons, due to which, it could become liable to claims by customers, suffer adverse publicity and incur substantial costs, which in turn could adversely affect our results of operations.*

Many of our orders involve manufacturing and fabricating the products on timely basis and delivering to the customers located outside India. These containers are loaded into trucks which are unloaded at the point of mode of transportation based on the location of the customer. The goods are transported by mode of road, water and air. We have entered into an arrangement for delivery of these products at the point of mode of transportation adopted by the customer based on their location. Further, any failure or defect in the products or services could result in a claim against us for substantial damages, regardless of our responsibility for such a failure or defect. Any failure to meet the scheduled timelines set by our customers may lead to our customers raising claims against us.

We are dependent on few logistical service providers for supply of textile products from the place of the supplier to the destination of the ultimate buyer. Accordingly, continuing increase in transportation costs or unavailability of transportation services for delivery of our textile products, as well the extent and reliability of Indian infrastructure may have an adverse effect on our business, financial condition, results of operations and prospects.

Moreover, our Company is attempting to limit its contractual liability for all the damages, including consequential damages, while manufacturing the products, our Company cannot be assured that the limitations on liability it provides for, in the contracts will be enforceable in all cases.

11. *Improper handling of machineries could result in accidents and may lead to loss of life and may have an impact on the image of our business which could have an adverse effect on our net sales, profitability and results of our operations.*

Improper handling of machines used in the business line of the Company can result into accidents at times and may lead to loss of life of the employees and the Company could face liabilities that may adversely affect its profits.

Our Company has been executing the variety of projects using modern techniques and state-of-the-art plant & equipment. Our Company has insured policies cover and has undertaken adequate safety measures, which have minimized the loss of three crucial M’s viz. men, material and machines. Also, our company employs skilled manpower to handle materials and machines and provide requisite in-house training for the same. In spite of the



same, in future due to improper handling of machineries which could result in accidents, it could have an adverse effect on our net sales, profitability and results of our operations.

- 12. Our Promoters play key role in our functioning and we heavily rely on their knowledge and experience in operating our business and therefore, it is critical for our business that our Promoters remain associated with us. Our success also depends upon the continued services of our promoters and our ability to attract, train and retain them.***

Our Company is promoted by a group of individuals and is led by Mr. Sanjay Patel who has approximate 36 years of experience. The success of our business operations is attributable to our Promoters, Directors and key management personnel. We believe that our relation with our Promoters, who have rich experience in setting up business, developing markets, managing customers and handling overall businesses, has enabled us to experience growth and profitability. We benefit from our relationship with our Promoters and Key Managerial Persons and our success depends upon their continuing services, who have been responsible for the growth of our business and are closely involved in the overall strategy, direction and management of our business. Our Promoter, Mr. Sanjay Patel, has been actively involved in the day to day operations and management since the incorporation of the Company.

Our Promoters, along with the group key managerial personnel, have over the years built relations with clients, government agencies and other persons who are connected with us. The loss of their services could impair our ability to implement our strategy, and our business, financial condition, results of operations and prospects may be materially and adversely affected.

Further, our Promoters have also promoted other companies and may continue to do so. If they divert their attention to the other companies, we may not be able to function as efficiently and profitably as before. We may have to incur additional costs to replace the services of our promoters or we may not be able to do so at all, which could adversely affect our business operations and affect our ability to continue to manage and expand our business. Any inability to attract and retain talented employees or the resignation or loss of key management personnel, may have an adverse impact on our business, future financial performance and the price of our Equity Shares.

- 13. We constantly face a credit risk which may in turn affect our complete cycle adversely. Also, any customer dispute regarding our performance or workmanship may amount in delay or withholding of payment to us.***

Our Company is involved in manufacturing and fabrication of various steel products which are meant for its application in Pipe Support Systems, HVAC Systems, Anti-vibration System and Equipments for Industrial, Commercial, Utility and OEM Installations. We manufacture various engineering products, metal and base metal products like G. I. nuts, various types of bolts, clamps, hangers etc. Further our Product Portfolio includes all types of bathroom pipes, fittings, bathroom accessories and sanitary wares. Moreover, we are also engaged in trading of Fabric and Textile related Products.

Our primary competence is the ability to provide timely deliveries and best quality products, further being able to exploit the benefits of economies of scale and credit shortage in the industry. Our business cycle is heavily dependent on timely payments being received from our customers. In case that our products are not delivered on timely basis and/or the quality of the products does not fulfil the requirements of our customer, it may lead to dissatisfaction. Further it may lead to consequence of customer dispute regarding our performance or workmanship and the customer may delay or withhold payment to us, which may result in materially affecting our business.

In case of such default in payment/ unforeseeable delay in payment from any of our customers our working capital cycle will be adversely affected. This may lead to lack of competitive advantage against various other transporters leading to an adverse effect on our business operations and profitability.



- 14. Our funding requirements and deployment of the issue proceeds are based on management estimates and have not been independently appraised by any bank or financial institution. Any variation in the utilization of our Net Proceeds as disclosed in this Prospectus would be subject to certain compliance requirements, including prior shareholders' approval.**

The deployment of the funds towards the objects of the Issue is entirely at the discretion of the Board and our Board will monitor the utilisation of Net Proceeds through its Audit Committee. Further, our Promoter or controlling shareholders would be required to provide an exit opportunity to the shareholders who do not agree with our proposal to change the objects of the Issue, at a price and manner as specified in Chapter VI-A of the SEBI ICDR Regulations pursuant to the SEBI ICDR (Second Amendment) Regulations, 2016 dated February 17, 2016. Additionally, the requirement on Promoters or controlling shareholders to provide an exit opportunity to such dissenting shareholders may deter the Promoters or controlling shareholders from agreeing to the variation of the proposed utilisation of our Net Proceeds, even if such variation is in our interest. Further, we cannot assure you that our Promoter or the controlling shareholders will have adequate resources at their disposal at all times to enable them to provide an exit opportunity at the price which may be prescribed by SEBI.

Our Company will disclose the utilisation of the Net Proceeds under a separate head along with details in its balance sheet until the Net Proceeds remain unutilised, clearly specifying the purpose for which the Net Proceeds have been utilised. Any inability on our part to effectively utilize the Issue proceeds could adversely affect our operational and financial performance.

- 15. We face foreign exchange risks that could adversely affect our results of operations, further having an impact on our cash flows and our financial results may fluctuate.**

We face foreign exchange rate risk as major portion of our revenues are denominated in a currency other than the Indian Rupee. Because of our foreign currency exposure, exchange rate fluctuations between the Indian Rupee and foreign currencies can have a material impact on our results of operations, cash flows and financial condition. The exchange rate between the Indian Rupee and U.S. dollar has been volatile in recent periods and may continue to fluctuate in the future. We generally received a part payment from the customers in advance, while others make the payment over a period of time. This gap results in increased risk towards foreign exchange fluctuation.

As we intend to expand our product base and also our geographical markets, we will have greater exposure to such exchange rate fluctuations. We may, therefore, suffer losses on account of foreign currency fluctuations for sale of our products since we may not be able to pass on all losses on account of foreign currency fluctuations to our customers. While we currently hedge some of our foreign currency exchange risks by entering into forward exchange contracts and seek to hedge some of our future transaction by entering into similar transactions, any amount that we spend or invest in order to hedge the risks to our business due to fluctuations in currencies may not adequately hedge against any losses that we may incur due to such fluctuations.

Moreover, the hedges may not cover all such exposures and are in any event subject to their own risks, including counterparty credit risk. Adverse moves in exchange rates may adversely impact our profitability and financial condition.

- 16. Our Company is dependent on the continuing operation of our manufacturing facilities. Any significant interruption in manufacturing at our facilities could have a material adverse effect on our business, results of operations and financial condition.**

Our Company manufactures substantially all of the products at our manufacturing facilities located at Vasai, which are subject to the normal risks of industrial production, including equipment breakdowns, labour stoppages, natural disasters, industrial accidents, power interruptions our inability to respond to technological advances and emerging industry standards and practices in the industry and the need to comply with the



directives of relevant government authorities. In case of any disruption at such facilities, it may adversely affect the manufacturing cycle, and may lead to time over-run in the execution of the project.

All of these manufacturing facilities require a significant amount and continuous supply of electricity and any shortage or non-availability of electricity may adversely affect our operations. The manufacturing process of our products requires significant electricity. Our Company depends on MSEDCL for supply of our energy requirements. For further information, see “Government and Other Approvals” on page no. 197 of the Prospectus.

17. Our Company has reported certain negative cash flows from its operating, investing and financing activities, details of which are given below. Sustained negative cash flow could impact our growth and business in the future.

Our Company had reported certain negative cash flows from its operating, investing and financing activities in the previous years as per the restated financial statements and the same are summarized as under:

(₹ in lakhs)

Particulars	For the year ended March 31,				
	2018	2017	2016	2015	2014
Cash flow from Operating Activities	(621.86)	224.64	(84.62)	(12.52)	(35.13)
Cash flow from Investing Activities	(132.13)	(148.97)	(6.52)	(121.90)	(7.58)
Cash flow from Financing Activities	821.74	(55.77)	114.96	140.10	42.50

For details, please refer “Management’s Discussion and Analysis of Financial Conditions and Results of Operations of our Company” on page no. 174 of this Prospectus.

Cash flow of a company is a key indicator to show the extent of cash generated from operations to meet capital expenditure, pay dividends, repay loans and make new investments without raising finance from external resources. If our Company is not able to generate sufficient cash flows, it may adversely affect our business and financial operations.

18. There exists certain conflict of interest between our Company and our Group Company

Our Promoters are Directors in Tembo Exim Pvt. Ltd. which is our Group Company and has similar business activities in the segment of trading of fabric and textile related products as per its past history. Given current scenario, there is no material conflict of interest in case of products manufactured by us; which are majorly exported. Our Group Company does not specifically compete with our existing lines of business in case of manufactured products exported by us.

Further, our Company does not have any non-compete or such other agreement / arrangement with our Group Company For further details, please refer to the chapters titled ‘Our Business’, ‘Our Group Company’, beginning on page nos. 96 and 146, respectively and Financial Statements- Related Party Transactions” beginning on page no. 151 of this Prospectus.

19. The prices we are able to obtain for the textile products that we trade depend largely on prevailing market prices. Further, due to introduction of new taxes on textile products, it could have an impact on our trading activities.

The price of the products traded by us has a significant impact on our profits. Textiles has been subject to price fluctuations resulting from weather, domestic and foreign trade policies, shifts in supply and demand and other factors beyond our control. As a result, any fluctuation in prices could have a material adverse effect on our Company and our results of operations. Further, the fabric trading division mostly dealt with small and medium traders and manufacturers. After the introduction of GST many of our suppliers and customers have reduced their trading activities and hence we are in process of identifying new vendors / customers so that we can re-



build this division. This recent changes could have an overall impact on the operations of our Company and may ultimately affect the results and financial condition alongwith the profitability.

- 20. *Our Company does not own some of our key properties which are used by us currently for manufacturing purpose and further in case of unavailability of these properties, it would impact our operations, results and financial condition adversely.***

Our Registered Office situated at Plot No- PAP D-146/147, TTC MIDC, Turbhe, Navi Mumbai - 400705, has been obtained on long lease from MIDC. Though the long lease signifies a lease for a period of 99 years, as per the terms of MIDC, our Company is required to follow the terms and conditions of the deed for each of our properties. Any lapse in following the terms and conditions may result in MIDC withdrawing the lease or reducing the lease period.

Our Company operates from 3 manufacturing units situated at Vasai, which are not owned by the Company and have been obtained on lease. In case of any cancellation of lease due to any factors, we may not able find suitable locations to shift our manufacturing units or do it without incurring substantial additional expense. This may result in additional cost, disruption of day-to-day activities and increased rent burden which would adversely affect our financial condition. For details regarding such tenancy properties and leasehold properties, please refer to “*Our Business –Properties*” on page no. 112 of this Prospectus.

- 21. *Our manufacturing activities are dependent upon availability of skilled and unskilled labour.***

We have entered into an agreement with contract labourer for provision of skilled and unskilled labour. Our manufacturing activities are dependent on availability of skilled and unskilled labour. Non-availability of labour at any time or any disputes with them may affect our production schedule and timely delivery of our products to customers which may adversely affect our business and result of operations.

- 22. *Due to multiple base raw material and multiple end products it is not possible to ascertain our installed capacity & capacity utilization.***

We are in the business of process of manufacturing and fabrication of various steel products which are meant for its application in Pipe Support Systems, HVAC Systems, Anti-vibration System and Equipments for Industrial, Commercial, Utility and OEM Installations. Our Company also manufacture various engineering products, metal and base metal products like G. I. nuts, various types of bolts, clamps, hangers etc. Further the Product Portfolio also includes various types of bathroom pipes, fittings, bathroom accessories and sanitary wares. Due to multiple base raw material and multiple end products, it is not possible to ascertain the installed capacity & capacity utilization.

- 23. *We face competition in our business from both domestic and international competitors. Such competition may have a negative impact on our business prospects, future performance and financial condition.***

The industry, in which we are operating, is increasingly competitive and our results of operations and financial condition are sensitive to, and may be materially adversely affected by, competitive pricing and other factors.

Competition may result in pricing pressures, reduced profit margins or lost market share or a failure to grow our market share, any of which could substantially harm our business and results of operations.

There are various factors that could impair our ability to maintain our current levels of revenues and profitability in our goods transportation business, including the following:

- competition with other companies offering better pricing for the goods manufactured, some of which may have a wider range of product portfolio, and may have greater capital resources than we do;



- solicitation by customers of bids from multiple manufacturers and the resulting depression of the bidding prices or loss of business to competitors;
- development of an operational model similar to ours by a competitor with sufficient financial resources and comparable experience in the pipe support hanger & related metal products industry as well as textile industry;
- establishment of better relationships by our competitors with their customers; and
- the small unorganized players at a regional level may not comply with applicable statutory and regulatory requirements and due to which they may be able to operate at lower cost and consequently offer lower prices than us

There can be no assurance that we can effectively compete with our competitors in the future, and any such failure to compete effectively may have a material adverse effect on our business prospects, future performance, financial condition and results of operations.

Our Company's competitors may enjoy potential competitive advantages over us and may successfully attract our customers to their products/ services by matching or exceeding what we offer to our customers, such as:

- greater name/brand recognition, a longer operating history, wider geographical reach and wider customer base and extensive international operations;
- engage in price competition, reducing the product pricing;
- larger marketing and advertising budgets and resources;
- larger intellectual property portfolios; and
- greater financial, technical and other resources.

There can be no assurance that we will have sufficient resources to respond to competitors' investments in geographical and customer network and pricing and promotional programs.

If our Company is unable to effectively compete with other participants in the pipe support hanger & related metal products industry as well as textile industry, whether on the basis of pricing, product quality, services or otherwise, it might not be able to attract new customers or retain existing customers, and this could adversely affect our business, financial condition and results of operations.

24. Our insurance coverage may not adequately protect us against all material hazards, which may adversely affect our business, results of operations and financial condition.

Our business, manufacturing facilities, plant and machinery and other assets could suffer damage from fire, natural calamities, misappropriation or other causes, resulting in losses, which may not be fully compensated by insurance. There can be no assurance that the terms of our insurance policies will be adequate to cover any damage or loss suffered by our Company or that such coverage will continue to be available on reasonable terms or will be available in sufficient amounts to cover one or more large claims, or that the insurer will not disclaim coverage as to any future claim.

Further, our Company is required to renew these insurance policies from time to time and in the event, we fail to renew the insurance policies within the time period prescribed in the respective insurance policies or not obtain at all, our Company may face significant uninsured losses. If our Company suffers a large uninsured loss or if any insured loss suffered, significantly exceeds our insurance coverage, our business, financial condition and results of operations may be adversely affected.

25. We generally do business with our customers on purchase order basis and do not enter into long term contracts with most of them.

Our business is dependent on continuing relationships with our customers. Our Company neither has any long-term contract with any of customers nor has any marketing tie up for the fabric and textile related products



traded by us. Any change in the buying pattern of our customers from us can adversely affect the business of our Company. The loss of or interruption of work by, a significant customer or a number of significant customers or the inability to procure new orders on a regular basis or at all may have an adverse effect on our revenues, cash flows and operations.

26. *If the Company is increasingly dependent on a particular market or geography for exports, a downturn in it could dent our market share.*

Our products are sold within Indian markets and International markets like UK and various other countries in Middle East. Thus, the sales of the Company are widely dispersed throughout the global and any failure to maintain such dispersion may affect the market share of our revenue. Further in case of change in treaty between the Indian market and global countries may impact sales, revenues, and consequently, the financial performance of the Company.

27. *Changes in latest technology machinery/ requirement of machinery based on business opportunity may adversely affect our Company's results of operations and its financial condition.*

Modernisation and technology up gradation is essential to reduce costs and increase the output. Changes in technology may render our current technologies obsolete or require us to make substantial capital investments. However, our existing state-of-the-art manufacturing units have machineries with latest technology and we strive to keep our technology, equipments and machinery in line with the latest technological standards. But in future we may be required to implement new technology or upgrade the machineries and other equipment's employed by us. Further, the costs in upgrading our technology and modernizing the plant and machineries may be significant which could substantially affect our finances and operations.

Further in case of machinery requirement based on business opportunity/ latest technology machinery, we will have to incur huge expenditure which may adversely affect our Company's results of operations and its financial condition. Also up-gradation in our technology and key infrastructure on timely basis may hamper our operations and financial conditions.

28. *Non-compliance with and changes in, safety, health and environmental laws and other applicable regulations, may adversely affect Our Company's results of operations and its financial condition.*

Our Company is subject to Indian laws and government regulations, including in relation to safety, health and environmental protection. These safety, health and environmental protection laws and regulations inter alia impose controls on air and water discharge, noise levels, storage handling, employee exposure to hazardous substances and other aspects of our Company's operations and products. In addition, our products, including the process of manufacture, storage and distribution of such products, are subject to numerous laws and regulations in relation to quality, safety and health. Failure to comply with any existing or future regulations applicable to our Company may result in levy of fines, commencement of judicial proceedings and/or third party claims, and may adversely affect our results of operations and financial condition.

Further, there can be no assurance that our Company will not be involved in future litigation or other proceedings or be held responsible in any litigation or proceedings including in relation to safety, health and environmental matters, the costs of which could be material. Any accidents involving hazardous substances can cause personal injury and loss of life, substantial damage to or destruction of property and equipment and could result in a suspension of operations. The loss or shutdown of operations over an extended period at any of our Company's facilities would have a material adverse effect on our Company's business and operations.

29. *Our Company will not receive any proceeds from the Offer for Sale portion.*

This Issue comprises of an offer for sale of 2,45,000 Equity Shares by our Promoter Group Selling Shareholder, Mr. Piyush J Patel. The proceeds from the Offer pertaining to the above sale shares will be paid to the aforesaid



person and our Company will not receive any proceeds from the Offer. For further details, please refer the chapter titled “*Objects of the Issue*” on page no. 71 of the Prospectus.

30. *Substantial portion of our revenues has been dependent upon our few clients. The loss of any one or more of our major clients would have a material adverse effect on our business operations and profitability.*

For the period ended March 31, 2018 our top 10 clients contributed 62.65% of our sales. The loss of our major customers or a decrease in the volume of products sourced from us may adversely affect our revenues and profitability. We cannot assure you that we shall generate the same quantum of business, or any business at all, from these customers, and loss of business from one or more of them may adversely affect our operations and profitability.

31. *Our inability to manage growth could disrupt our business and reduce our profitability.*

A principal component of our strategy is to continue to grow by expanding the size and geographical scope of our businesses, as well as the development of our new products portfolio. This growth strategy will place significant demands on our management, financial and other resources. It will require us to continuously develop and improve our operational, financial and internal controls. Continuous expansion increases the challenges involved in financial management, maintaining good relationships with contract labour providers for retaining high quality human resources, preserving our culture, values and entrepreneurial environment, and developing and improving our internal administrative infrastructure. Any inability on our part to manage such growth could disrupt our business prospects, impact our financial condition and adversely affect our results of operations.

32. *Employee misconduct, errors or fraud could expose us to business risks or losses that could adversely affect our business prospects, results of operations and financial condition.*

Employee misconduct, errors or frauds could expose us to business risks or losses, including regulatory sanctions, penalties and serious harm to our reputation. Such employee misconduct includes breach in security requirements, misappropriation of funds, hiding unauthorized activities, failure to observe our stringent operational standards and processes, and improper use of confidential information. It is not always possible to detect or deter such misconduct, and the precautions we take to prevent and detect such misconduct may not be effective. In addition, losses caused on account of employee misconduct or misappropriation of petty cash expenses and advances may not be recoverable, which we may result in write-off of such amounts and thereby adversely affecting our results of operations. Our employees may also commit errors that could subject us to claims and proceedings for alleged negligence, as well as regulatory actions in which case, our reputation, business prospects, results of operations and financial condition could be adversely affected.

33. *Our Promoters and Promoter Group will continue to retain majority shareholding in us after the Issue, which will allow them to exercise significant influence over us and potentially create conflicts of interest.*

The current Issue includes fresh issue of Equity Shares and Offer for Sale by our Promoters and Promoter Group. Our Promoter and Promoter Group may beneficially own approximately 72.77% of our post-Issue equity share capital. As a result, the Promoter Group may have the ability to control our business including matters relating to any sale of all or substantially all of our assets, the timing and distribution of dividends and the election or termination of appointment of our officers and directors. This control could delay, defer or prevent a change in control of the Company, impede a merger, consolidation, takeover or other business combination involving the Company, or discourage a potential acquirer from making a tender offer or otherwise attempting to obtain control of the Company even if it is in the Company’s best interest. In addition, for so long as the Promoter Group continues to exercise significant control over the Company, they may influence the material policies of the Company in a manner that could conflict with the interests of our other shareholders. The Promoter Group may have interests that are adverse to the interests of our other shareholders and may take positions with which our other shareholders do not agree.



34. The rate of interest for the loans obtained by us from the banks and Financial Institutions is variable and any increase in interest rates may adversely affect our results of operations and financial condition.

Our Company is susceptible to changes in interest rates and the risks arising there from. Our sanction letters provide for interest at variable rates with a provision for the periodic resetting of interest rates. Further the lenders are entitled to change the applicable rate of interest, which is a combination of a base rate that depends upon the policies of the RBI and a contractually agreed spread, and in the event of an adverse change in our Company's credit risk rating. For further details of interest payable on our borrowings, please refer to the chapter titled "Financial Indebtedness" on page no.188 of this Prospectus. Further, in recent years, the Government of India has taken measures to control inflation, which have included tightening the monetary policy by raising interest rates. As such, any increase in interest rates may have an adverse effect on our business, results of operations, cash flows and financial condition.

35. There are various negative covenants in the sanction letters issued to us by our lenders, which could put us at a competitive disadvantage and could have an adverse effect on our business, results of operations and financial condition.

The sanction letter issued to us contains provisions that restrict our ability to do, among other things, any of the following:

- Changing or alter the Capital Structure of the Company;
- Entering into amalgamation, reconstruction, re-organisation, takeover or any other schemes of compromise or arrangement;
- Not implementing any scheme of expansion or diversification or capital expenditure except normal replacements indicate in Funds Flow Statement submitted
- Non- diversion of funds to any other purpose.
- Non-declaring of dividends/ withdrawal of any amount in any form of salary/ remuneration/ incentive/ commission by the Promoters/ Directors in case of overdue with the Bank

Further the company has created a charge on its assets in favour of their bankers against the assets of the company. In case of default by the company in repayment of the loans, bankers may exercise their rights over the security, which may be detrimental to the interest of the company. For details, please refer "*Financial Indebtedness*" on page no. 188 of this Prospectus.

In addition to the restrictions listed above, we are required to maintain certain financial ratios under our financing agreements. These financial ratios and the restrictive provisions could limit our flexibility to engage in certain business transactions or activities.

Additionally, our borrowings are secured by our movable assets (whether existing or future) and by a personal guarantee of our Promoter / Promoter Group/ Directors. Such securities enable the lenders to cancel any outstanding commitments, accelerate the repayment, exercise cross default provisions and enforce their security interests on the occurrence of events of default such as a breach of financial covenants, failure to obtain the proper consents, failure to perfect security as specified and such other covenants that are not cured. It is possible that we may not have sufficient funds upon such an acceleration of our financial obligations to pay the principal amount and interest in full. Further, if we are forced to issue additional equity to the lenders, your ownership interest in our Company will be diluted. It is also possible that future financing agreements may contain similar or more onerous covenants and may also result in higher interest cost. If any of these events were to occur, our business, results of operations and financial condition may be adversely affected.



36. In addition to normal remuneration, other benefits and reimbursement of expenses our Directors (including our Promoters) and Key Management Personnel are interested in our Company to the extent of their shareholding and dividend entitlement in our Company.

Some of our Directors (including our Promoters) and Key Management Personnel are interested in our Company to the extent of their shareholding and dividend entitlement in our Company, in addition to normal remuneration, incentives or benefits and reimbursement of expenses. We cannot assure you that our Directors or our Key Management Personnel would always exercise their rights as Shareholders to the benefit and best interest of our Company. As a result, our Directors will continue to exercise significant control over our Company, including being able to control the composition of our board of directors and determine decisions requiring simple or special majority voting, and our other Shareholders may be unable to affect the outcome of such voting. Our Directors may take or block actions with respect to our business, which may conflict with our best interests or the interests of other minority Shareholders, such as actions with respect to future capital raising or acquisitions. We cannot assure you that our Directors will always act to resolve any conflicts of interest in our favour, thereby adversely affecting our business and results of operations and prospects.

37. The deployment of the Net Proceeds from the Fresh Issue are based on management estimates and have not been independently appraised by any bank or financial institution and is not subject to any monitoring by any independent agency and our Company's management will have flexibility in utilizing the Net Proceeds from the Fresh Issue.

Our Company intends to primarily use the Net Proceeds from the Fresh Issue towards Working Capital requirement as described in "Objects of the Issue" on page no. 71 of this Prospectus. In terms of Regulation 16 of the SEBI (ICDR) Regulations, we are not required to appoint a monitoring agency since the fresh Issue size is not in excess of ₹ 10,000 lakhs. The management of our Company will have discretion to use the Net Proceeds from the Fresh Issue, and investors will be relying on the judgment of our Company's management regarding the application of the Net Proceeds from the Fresh Issue. Our Company may have to revise its management estimates from time to time and consequently its requirements may change. Additionally, various risks and uncertainties, including those set forth in this section "Risk Factors", may limit or delay our Company's efforts to use the Net Proceeds from the Fresh Issue to achieve profitable growth in its business.

Further, pursuant to Section 27 of the Companies Act 2013, any variation in the objects would require a special resolution of the Shareholders and our Promoters or controlling Shareholders will be required to provide an exit opportunity to the Shareholders of our Company who do not agree to such proposal to vary the objects, in such manner as may be prescribed in future by the SEBI.

Accordingly, prospective investors in the Issue will need to rely upon our management's judgment with respect to the use of Net Proceeds. If we are unable to enter into arrangements for utilization of Net proceeds as expected and assumed by us in a timely manner or at all, we may not be able to derive the expected benefits from the proceeds of the Issue and our business and financial results may suffer.

38. We have issued Equity Shares during the last year at a price that may be below the Issue Price.

We have issued certain Equity Shares in the last twelve months, at a price that may be lower than the Issue Price. Details of such issuances are given in the table below:

Date of Allotment	No. of Equity Shares	Issue Price (₹)	Nature of Allotment	Allotted Person
November 07, 2017	6,00,000	26	Right Issue	Mrs. Fatema S Kachwala
March 20, 2018	2,08,625	Nil	Bonus Issue	Mr. Sanjay J Patel
March 20, 2018	1,48,125	Nil	Bonus Issue	Mrs. Smita S Patel
March 20, 2018	1,85,625	Nil	Bonus Issue	Mr. Piyush J Patel
March 20, 2018	1,73,125	Nil	Bonus Issue	Mrs. Taruna P Patel



Date of Allotment	No. of Equity Shares	Issue Price (₹)	Nature of Allotment	Allotted Person
March 20, 2018	5,34,500	Nil	Bonus Issue	Mrs. Fatema S Kachwala
March 20, 2018	25,000	Nil	Bonus Issue	Mr. Rushil P Patel
March 20, 2018	25,000	Nil	Bonus Issue	Mrs. Priyanka M Geelani

For Further details of equity shares issued, please refer to the section titled “*Capital Structure*” beginning on page no. 60 of this Prospectus.

39. *Our Promoters and Directors have extended personal guarantees in connection with certain of our debt facilities. There can be no assurance that such personal guarantees will be continued to be provided by our Promoters/ Directors in the future or can be called at any time, affecting the financial.*

Our Promoters and Directors have provided personal guarantees for our borrowings to secure our loans. If any of these guarantees are revoked, our lenders may require alternative guarantees or collateral or cancellation of such facilities, entailing repayment of amounts outstanding under such facilities. If we are unable to procure alternative guarantees satisfactory to our lenders, we may need to seek alternative sources of capital, which may not be available to us at commercially reasonable terms or at all, or to agree to more onerous terms under our financing agreements, which may limit our operational flexibility. Accordingly, our business, financial condition, results of operations, cash flows and prospects may be adversely affected by the revocation of all or any of the personal guarantees provided by our Promoters/ Directors in connection with our Company’s borrowings.

40. *We have not identified any alternate source of raising the funds mentioned as our ‘Objects of the Issue’. Any shortfall in raising / meeting the same could adversely affect our growth plans, operations and financial performance.*

Our Company has not identified any alternate source of funding and hence any failure or delay on our part to mobilize the required resources or any shortfall in the Issue proceeds can adversely affect our growth plan and profitability. The delay/shortfall in receiving these proceeds could result in inadequacy of funds for working capital or may result in us borrowing funds on unfavourable terms, both of which scenarios may affect the business operation and financial performance of the company.

41. *In the event there is any delay in the completion of the Issue, there would be a corresponding delay in the completion of the objects / schedule of implementation of this Issue which would in turn affect our revenues and results of operations.*

The funds that we receive would be utilized for the Objects of the Fresh Issue as has been stated in the Chapter “*Objects of the Issue*” on page no. 71 of this Prospectus. The proposed schedule of implementation of the objects of the Issue is based on our management’s estimates. If the schedule of implementation is delayed for any other reason whatsoever, including any delay in the completion of the Issue, we may have to revise our business, development and working capital plans resulting in unprecedented financial mismatch and this may adversely affect our revenues and results of operations.

42. *The requirements of being a public listed company may strain our resources and impose additional requirements.*

With the increased scrutiny of the affairs of a public listed company by shareholders, regulators and the public at large, we will incur significant legal, accounting, corporate governance and other expenses that we did not incur in the past. We will also be subject to the provisions of the listing agreements signed with the Stock Exchanges which require us to file unaudited financial results on a quarterly basis. In order to meet our financial control and disclosure obligations, significant resources and management supervision will be required. As a result, management’s attention may be diverted from other business concerns, which could have an adverse



effect on our business and operations. There can be no assurance that we will be able to satisfy our reporting obligations and/or readily determine and report any changes to our results of operations in a timely manner as other listed companies. In addition, we will need to increase the strength of our management team and hire additional legal and accounting staff with appropriate public company experience and accounting knowledge and we cannot assure that we will be able to do so in a timely manner.

RISK FACTORS RELATED TO EQUITY SHARES

43. Any further issuance of Equity Shares by Our Company or sales of Equity Shares by any significant shareholders may adversely affect the trading price of the Equity Shares.

Any future issuance of Equity Shares by our Company could dilute the investors' shareholding. Any such future issuance of Equity Shares or sales of Equity Shares by any of our significant shareholders may also adversely affect the trading price of the Equity Shares, and could impact our ability to raise capital through an offering of securities. In addition, any perception by investors that such issuances or sales might occur could also affect the trading price of the Equity Shares.

44. There is no existing market for our Equity Shares, and we do not know if one will develop. Our stock price may be highly volatile after the Issue and, as a result, you could lose a significant portion or all of your investment.

There is no guarantee that our Equity Shares will be listed on the Stock Exchanges in a timely manner or at all and any trading closures at the Stock Exchanges may adversely affect the trading price of our Equity Shares. Prior to the Issue, there has not been a public market for the Equity Shares. Further, we cannot predict the extent to which investor interest will lead to the development of an active trading market on the Stock Exchanges or how liquid that market will become. If an active market does not develop, you may experience difficulty selling the Equity Shares that you purchased. The Issue Price is not indicative of prices that will prevail in the open market following the Issue. Consequently, you may not be able to sell your Equity Shares at prices equal to or greater than the Issue Price. The market price of the Equity Shares on the Stock Exchanges may fluctuate after listing as a result of several factors, including the following:

- Volatility in the Indian and other Global Securities Markets;
- The performance of the Indian and Global Economy;
- Risks relating to our business and industry, including those discussed in this Prospectus;
- Strategic actions by us or our competitors;
- Investor perception of the investment opportunity associated with the Equity Shares and our future performance;
- Adverse media reports about us, our shareholders or Group Company;
- Future sales of the Equity Shares;
- Variations in our half yearly results of operations;
- Differences between our actual financial and operating results and those expected by investors and analysts;
- Our future expansion plans;
- Perceptions about our future performance or the performance of Pipe Hanger Support and Steel Industry sector as well as textile industry companies generally;
- Performance of our competitors in the Pipe Hanger Support and Steel Industry as well as textile industry and the perception in the market about investments in the same;
- Significant developments in the regulation of the manufacturing of Pipe Hanger Support and Steel Industry as well as textile industry in our key locations;
- Changes in the estimates of our performance or recommendations by financial analysts;
- Significant developments in India's economic liberalisation and deregulation policies; and
- Significant developments in India's fiscal and environmental regulations. There has been significant volatility in the Indian stock markets in the recent past, and our Equity Share



Price could fluctuate significantly as a result of market volatility. A decrease in the market price of the Equity Shares could cause you to lose some or all of your investment.

- 45. *There are restrictions on daily movements in the price of the Equity Shares, which may adversely affect a shareholder's ability to sell, or the price at which it can sell, the Equity Shares at a particular point in time.***

The price of the Equity Shares will be subject to a daily circuit breaker imposed by all stock exchanges in India which does not allow transactions beyond a certain level of volatility in the price of the Equity Shares. This circuit breaker operates independently of the index-based market-wide circuit breakers generally imposed by the SEBI on Indian stock exchanges. The percentage limit on our circuit breaker is set by the stock exchanges based on the historical volatility in the price and trading volume of the Equity Shares. The stock exchanges do not inform us of the percentage limit of the circuit breaker from time to time, and may change it without our knowledge. This circuit breaker effectively limits upward and downward movements in the price of the Equity Shares. As a result, shareholders' ability to sell the Equity Shares, or the price at which they can sell the Equity Shares, may be adversely affected at a particular point in time.

- 46. *Our ability to pay dividends in the future may be affected by any material adverse effect on our future earnings, financial condition or cash flows.***

Our ability to pay dividends in future will depend on our earnings, financial condition and capital requirements. In the past, we have not made dividend payments to the Shareholders of our Company. The Company may decide to retain all future earnings, if any, for use in the operations and expansion of the business. In such situation, the Company may not declare dividends in the foreseeable future. Any future determination as to the declaration and payment of dividends will be at the discretion of our Board and will depend on factors that our Board deems relevant, including among others, our future earnings, financial condition, cash requirements, business prospects and any other financing arrangements. We cannot state with any certainty whether we will be able to pay dividends in the future. Accordingly, realization of a gain on Shareholders' investments will depend on the appreciation of the price of the Equity Shares. There is no guarantee that our Equity Shares will appreciate in value.

- 47. *Investors would be subject to Indian taxes arising out of capital gains on the sale of the Equity Shares. The Finance Act, 2018 levies taxes on long term capital gains exceeding ₹ 1,00,000 arising from sale of equity shares on or after April 1, 2018, while continuing to exempt unrealised capital gains earned up to January 31, 2018 on equity shares.***

Under current Indian tax laws, capital gains arising from the sale of Equity Shares in an Indian company are generally taxable in India. However, any gain realized on the sale of listed equity shares on or before March 31, 2018 on a stock exchange held for more than 12 months will not be subject to long term capital gains tax in India if Securities Transaction Tax ("STT") is paid on the sale transaction and additionally, as stipulated by the Finance Act, 2017, STT had been paid at the time of acquisition of such equity shares on or after October 1, 2004, except in the case of such acquisitions of equity shares which are not subject to STT, as notified by the Central Government under notification no. 43/2017/F. No. 370142/09/2017- TPL on June 5, 2017. However, the Finance Act, 2018, has now levied taxes on such long term capital gains exceeding ₹ 1,00,000 arising from sale of Equity Shares on or after April 1, 2018, while continuing to exempt the unrealised capital gains earned up to January 31, 2018 on such Equity Shares subject to specific conditions. Accordingly, you may be subject to payment of long term capital gains tax in India, in addition to payment of STT, on the sale of any Equity Shares held for more than 12 months. STT will be levied on and collected by a domestic stock exchange on which the Equity Shares are sold.

Further, any gain realized on the sale of listed equity shares held for a period of 12 months or less will be subject to short term capital gains tax in India. Capital gains arising from the sale of the Equity Shares will be exempt from taxation in India in cases where the exemption from taxation in India is provided under a treaty



between India and the country of which the seller is resident. Generally, Indian tax treaties do not limit India's ability to impose tax on capital gains. As a result, residents of other countries may be liable for tax in India as well as in their own jurisdiction on a gain upon the sale of the Equity Shares.

EXTERNAL RISK FACTORS

48. The GoI has implemented a new national tax regime by imposing GST.

The GoI has implemented a comprehensive national GST regime from July 01, 2017 that will combine taxes and levies by the Central and State Governments into a unified rate structure. GST is a dual levy with state GST and central GST. Central GST will replace the current central taxes and duties such as excise duty, service tax, counter veiling duty, special additional duty of customs, central charges and cesses. The state GST will replace local state taxes like VAT, CST, octroi and others including state cesses and charges.

Any future increases or amendments may affect the overall tax efficiency of companies operating in India and may result in significant additional taxes becoming payable.

Our business being construction centric, most of the current central taxes and duties and local state taxes and duties are applicable to our business. We are in the process to understand the quantification of the impact of this development at this stage due to limited information available in the public domain. If we are taxed at a higher rate than the current tax rates, our financial condition and results of operations may be adversely affected.

Further, we may also be required to make changes in our internal process to adapt to the requirements of GST. We cannot assure you if we will be able to effectively carry out such changes. To ensure compliance with the requirements of the GST laws, we may also need to allocate additional resources, which may increase our regulatory compliance costs and divert management attention. Any increase in our compliance requirements or in our compliance costs may have an adverse effect on our business and results of operations.

49. The Companies Act, 2013 has effected significant changes to the existing Indian company law framework, which may subject us to higher compliance requirements and increase our compliance costs.

A majority of the provisions and rules under the Companies Act, 2013 have recently been notified and have come into effect from the date of their respective notification, resulting in the corresponding provisions of the Companies Act, 1956 ceasing to have effect. The Companies Act, 2013 has brought into effect significant changes to the Indian company law framework, such as in the provisions related to issue of capital, disclosures in offer document, corporate governance norms, audit matters, related party transactions, introduction of a provision allowing the initiation of class action suits in India against companies by shareholders or depositors, a restriction on investment by an Indian company through more than two layers of subsidiary investment companies (subject to certain permitted exceptions), prohibitions on loans to directors and insider trading and restrictions on directors and key managerial personnel from engaging in forward dealing. Further, companies meeting certain financial thresholds are also required to constitute a committee of the board of directors for corporate social responsibility activities and ensure that at least 2% of the average net profits of the company during three immediately preceding financial years are utilized for corporate social responsibility activities. Penalties for instances of non-compliance have been prescribed under the Companies Act, 2013, which may result in inter alia, our Company, Directors and key managerial employees being subject to such penalties and formal actions as prescribed under the Companies Act, 2013, should we not be able to comply with the provisions of the New Companies Act within the prescribed timelines, and this could also affect our reputation.

To ensure compliance with the requirements of the Companies Act, 2013 within the prescribed timelines, we may need to allocate additional resources, which may increase our regulatory compliance costs and divert management attention. While we shall endeavour to comply with the prescribed framework and procedures, we may not be in a position to do so in a timely manner.



The Companies Act, 2013 introduced certain additional requirements which do not have corresponding equivalents under the Companies Act, 1956. Accordingly, we may face challenges in interpreting and complying with such provisions due to limited jurisprudence on them. In the event, our interpretation of such provisions of the Companies Act, 2013 differs from, or contradicts with, any judicial pronouncements or clarifications issued by the Government in the future, we may face regulatory actions or we may be required to undertake remedial steps. Additionally, some of the provisions of the Companies Act, 2013 overlap with other existing laws and regulations (such as the corporate governance norms and insider trading regulations). We may face difficulties in complying with any such overlapping requirements. Further, we cannot currently determine the impact of provisions of the Companies Act, 2013, which are yet to come in force. Any increase in our compliance requirements or in our compliance costs may have an adverse effect on our business and results of operations.

50. *Any changes in the regulatory framework could adversely affect our operations and growth prospects.*

Our Company is subject to various regulations and policies. For details see section titled “*Key Industry Regulations and Policies*” beginning on page no. 115 of this Prospectus. Our business and prospects could be materially adversely affected by changes in any of these regulations and policies, including the introduction of new laws, policies or regulations or changes in the interpretation or application of existing laws, policies and regulations. There can be no assurance that our Company will succeed in obtaining all requisite regulatory approvals in the future for our operations or that compliance issues will not be raised in respect of our operations, either of which could have a material adverse affect on our business, financial condition and results of operations.

51. *Changing laws, rules and regulations and legal uncertainties, including adverse application of corporate and tax laws, may adversely affect our business, results of operations, financial condition and prospects.*

The regulatory and policy environment in which we operate is evolving and subject to change. Such changes, including the instances mentioned below, may adversely affect our business, results of operations, financial condition and prospects, to the extent that we are unable to suitably respond to and comply with any such changes in applicable law and policy.

52. *Civil disturbances, extremities of weather, regional conflicts and other political instability may have adverse affects on our operations and financial performance.*

Certain events that are beyond our control such as earthquake, fire, floods and similar natural calamities may cause interruption in the business undertaken by us. Our operations and financial results and the market price and liquidity of our equity shares may be affected by changes in Indian Government policy or taxation or social, ethnic, political, economic or other adverse developments in or affecting India.

53. *Terrorist attacks, civil unrest and other acts of violence or war involving India and other countries could adversely affect the financial markets and our business.*

Terrorist attacks and other acts of violence or war may negatively affect the Indian markets on which our Equity Shares will trade and also adversely affect the worldwide financial markets. These acts may also result in a loss of business confidence, impede travel and other services and ultimately adversely affect our business. In addition, any deterioration in relations between India and Pakistan might result in investor concern about stability in the region, which could adversely affect the price of our Equity Shares.

India has also witnessed civil disturbances in recent years and it is possible that future civil unrest as well as other adverse social, economic and political events in India could have a negative impact on the value of share prices generally as well as the price of our Equity Shares. Such incidents could also create a greater perception that investment in Indian companies involves a higher degree of risk and could have an adverse impact on our business and the price of our Equity Shares.



54. *Instability in financial markets could materially and adversely affect our results of operations and financial condition.*

The Indian economy and financial markets are significantly influenced by worldwide economic, financial and market conditions. Any financial turmoil, especially in the United States of America or Europe, may have a negative impact on the Indian economy. Although economic conditions differ in each country, investors' reactions to any significant developments in one country can have adverse effects on the financial and market conditions in other countries. A loss in investor confidence in the financial systems, particularly in other emerging markets, may cause increased volatility in Indian financial markets.

The global financial turmoil, an outcome of the sub-prime mortgage crisis which originated in the United States of America, led to a loss of investor confidence in worldwide financial markets. Indian financial markets have also experienced the contagion effect of the global financial turmoil, evident from the sharp decline in SENSEX, BSE's benchmark index. Any prolonged financial crisis may have an adverse impact on the Indian economy and us, thereby resulting in a material and adverse effect on our business, operations, financial condition, profitability and price of our Equity Shares.

55. *Any downgrading of India's debt rating by a domestic or international rating agency could adversely affect our Company's business.*

Any adverse revisions to India's credit ratings for domestic and international debt by domestic or international rating agencies may adversely affect our Company's ability to raise additional financing, and the interest rates and other commercial terms at which such additional financing is available. This could harm our Company's business and financial performance and ability to obtain financing for capital expenditures.

56. *Conditions in the Indian securities market and stock exchanges may affect the price and liquidity of our Equity Shares.*

Indian stock exchanges, which are smaller and more volatile than stock markets in developed economies, have in the past, experienced problems which have affected the prices and liquidity of listed securities of Indian companies. These problems include temporary exchange closures to manage extreme market volatility, broker defaults, settlement delays and strikes by brokers. In addition, the governing bodies of the Indian stock exchanges have from time to time restricted securities from trading, limited price movements and restricted margin requirements. Further, disputes have occurred on occasion between listed companies and the Indian stock exchanges and other regulatory bodies that, in some cases, have had a negative effect on market sentiment. If similar problems occur in the future, the market price and liquidity of the Equity Shares could be adversely affected. Further, a closure of, or trading stoppage on, either of the Stock Exchanges could adversely affect the trading price of our Equity Shares.

PROMINENT NOTES

1. Investors are free to contact the Lead Manager for any clarification, complaint or information pertaining to the Issue. The Lead Manager and our Company shall make all information available to the public and investors at large and no selective or additional information would be made available for a section of the investors in any manner whatsoever.
2. The Net Worth of our Company is ₹ 732.23 lakhs and the book value of each Equity Share was ₹ 18.78 as of March 31, 2018 as per our Restated Financial Statements. For more information, please refer the Section titled "*Financial Information*" beginning on page no. 151 of this Prospectus.
3. Public Issue of 13,68,000 lakh Equity Shares for cash at price of ₹ 69/- per share including a premium of ₹ 59/- aggregating to ₹ 943.92 lakhs. The Issue will constitute 27.23% of the post-Issue paid-up Equity Share capital of our Company.



4. The average cost of acquisition of Equity Shares by our Promoters is:

Promoter	Average cost (₹)
Mr. Sanjay J Patel	1.40
Mrs. Smita S Patel	6.33
Mrs. Taruna P Patel	4.84
Mrs. Fatema S Kachwala	17.61

5. Investors are advised to refer to the chapter titled “*Basis for Issue Price*” beginning on page no. 78 of this Prospectus.
6. The details of transactions by our Company with our Group Companies or associate during the last year are disclosed under “*Annexure XXV - Related Party Transactions*” on page no. 169 of this Prospectus.
7. There are no financing arrangements whereby the Promoter Group, the Directors of our Company who are the Promoters of our Company, the Directors of our Company and their relatives have financed the purchase by any other person of securities of our Company during the period of 6 (six) months immediately preceding the date of this Prospectus.
8. Our Company was incorporated as Saketh Exim Private Limited on June 16, 2010 under the Companies Act, 1956 with the Registrar of Companies, Mumbai bearing Registration No. 204331. Subsequently, the status of our Company was changed to a public limited company and the name of our Company was changed to Saketh Exim Limited vide Special Resolution dated December 07, 2017. A fresh certificate of incorporation consequent upon conversion was granted to our Company on December 19, 2017, by the Registrar of Companies, Mumbai. The Corporate Identity Number of our Company is U29253MH2010PLC204331.



SECTION III – INTRODUCTION

SUMMARY OF INDUSTRY

OVERVIEW OF THE INDIAN ECONOMY

India has emerged as the fastest growing major economy in the world as per the Central Statistics Organisation (CSO) and International Monetary Fund (IMF) and it is expected to be one of the top three economic powers of the world over the next 10-15 years, backed by its strong democracy and partnerships.. Indian economy is expected to grow at a rate of 6.7 per cent in the year 2017-18 and in the next financial year 2018-19 the economy is expected to grow at a rate of 7.2 per cent. The improvement in India's economic fundamentals has accelerated in the year 2015 with the combined impact of strong government reforms, Reserve Bank of India's (RBI) inflation focus supported by benign global commodity prices.

(Source: <https://www.ibef.org/economy/indian-economy-overview>)

During September 2017, eight core infrastructure industries grew by 5.2 per cent, as compared to 4.9 per cent growth in August 2017 and 5.3 per cent growth in September 2016. The growth of core industries during April-September 2017 was 3.3 per cent, as compared to 5.4 per cent growth during the same period last year.

Overall growth in the Index of Industrial Production (IIP) was 3.8 per cent in September 2017, as compared with 4.3 per cent growth in August 2017 and 5.0 per cent growth in September 2016. During April-September 2017, IIP growth was 2.5 per cent as compared to growth of 5.9 per cent during the same period last year.

Foreign exchange reserves were US\$ 398.8 billion as on October 27, 2017, as against US\$ 370 billion in March 2017.

(Source: *Indian Economic Development and Growth Monthly Economic Report- www.ibef.org*)

Economic growth is projected to remain strong and India will remain the fastest growing G20 economy. The increase in public wages and pensions will support consumption. Private investment will recover gradually as excess capacity diminishes, and the landmark Goods and Services Tax and other measures to improve the ease of doing business are being implemented. However, large non-performing loans and high leverage of some companies are holding back investment. Monetary policy is projected to remain tight as inflation expectations have still not fully adjusted down. The need to reduce the relatively high public-debt-to-GDP ratio leaves little room for fiscal stimulus.

(Source: <http://www.oecd.org/eco/outlook/economic-forecast-summary-india-oecd-economic-outlook-june-2017.pdf>)

INTRODUCTION TO PIPE SUPPORTS

Pipe Supports

Pipe is held either from above by hangers or supports of various types on which it rests. *Hangers are also referred to as supports.*

There are a number of typical pipe supports that can be installed to support dead weight loads, and restrain the pipe for thermal and dynamic loads. The designs are only limited by the imagination of the engineer and designer, as literally thousands of different designs have been used for special purposes. Pipe is rested on or secured to a support member usually of a standard structural shape (I-beam, wide flange beam, angle, channel etc.). The pipe may be secured to this member with a pipe support.

Pipe supports and hangers are devices which transfer the loads from the pipe or the structural attachment to the supporting structure or equipment. They include rod hangers, spring hangers, sway braces, turnbuckles, struts, anchors, saddles, rollers, brackets, and sliding supports. Structural attachments are elements that are welded, bolted, or clamped to the pipe, such as clips, lugs, clamps, clevises, and stops.



The correct and economical selection of the supports for any piping system usually presents difficulties of varying degrees, some relatively minor and others of a more critical nature. Proper support selection should be the objective of all phases of design and construction.

(Source: <http://wermac.org/steel/pipesupports.html>)

Typical Pipe Shoe

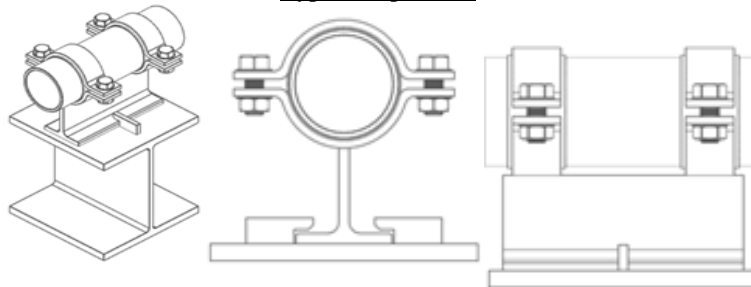

Typical Dummy Leg Support

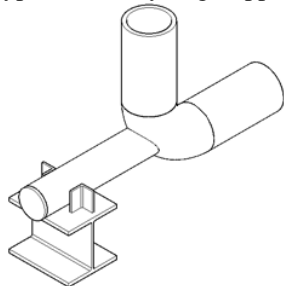

Typical Rod Hanger

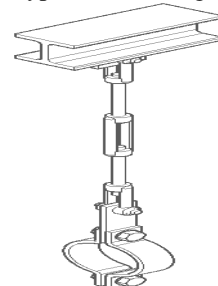

(Source: <http://wermac.org/steel/pipesupports.html>)

OFTEN USED PIPE SUPPORTS

Anchors

A rigid support that restricts movement in all three orthogonal directions and all three rotational directions. This usually is a welded stanchion that is welded or bolted to steel or concrete.

Two types of anchors exist: fixed and directional. Fixed anchors are used in locations where all movement of a line must be prevented. In piping terms this is called a fixed point. The most common way to anchor a pipe is to weld the pipe directly to a support or structural member. If the pipe to be anchored is insulated, first a pipe shoe is welded to the pipe and then the shoe is welded to the steel structure.

Directional anchors are used to force movement to occur in one direction while preventing it from occurring in the opposite direction. Directional anchors are used to direct a pipe's movement away from buildings, structures, equipment etc.

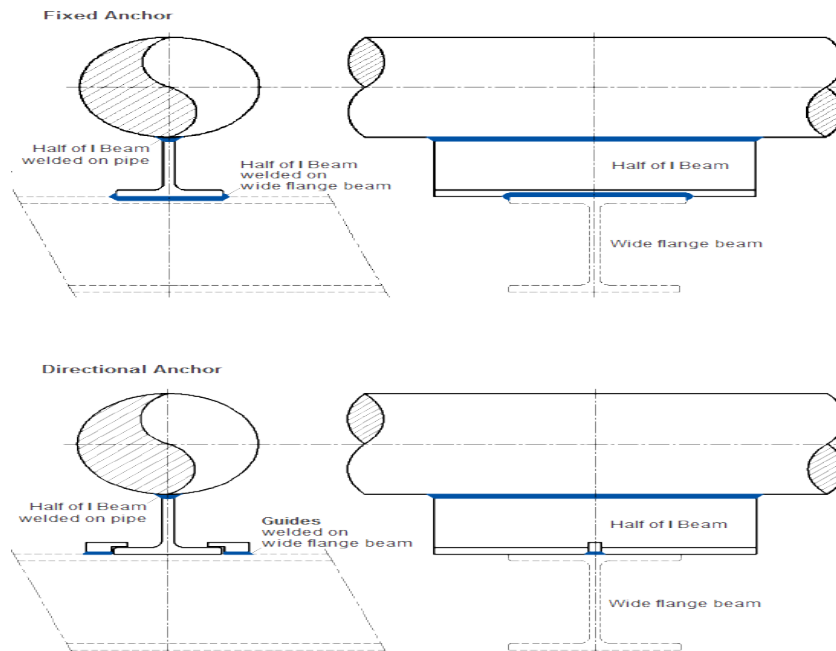

DUMMY LEG SUPPORTS

A dummy leg is an extension piece welded to an elbow in order to support a pipe line, and rests or anchors on some steel member.

Pipe size, length and wall thickness of the pipe-extension depends on several factors such as the total load, the parent pipe line size etc. *See typical dummy leg image on the right of this page.*

HANGER RODS

A vertical pipe support that incorporates a rod. It may be a rigid, variable spring or constant support hanger. Hanger is a term that often means quite different things to different people.

Rod hangers or pipe hanger's attaches to the pipe by a U bolt, a clevis, and a pipe clamp etc. to structural steel above. The rod hanger provides support in the vertical direction and allows limited motion in the horizontal direction. Adjustment in the vertical direction can be accomplished by threads or a turnbuckle. *See hanger rod image on the right of this page.*

GUIDES

When total restriction of pipe movement is not required, pipe guides are used.

Pipe guides confine movement along the pipe's lineal axis. In piping terms this is called a sliding point. They are used primarily to maintain proper line spacing in a pipe rack and they prevent lateral or sideways movement.

Unlike the pipe anchor which is welded to the pipe and steel structure, the guide allows pipe to slide lengthwise between two angle shapes. When the pipe is supported on shoes, the angle shapes are positioned on either side of the shoe. *For an image of guides see directional anchor above.*



CONSTANT LOAD HANGER

A specially engineered hanger that is designed to travel through many inches of vertical travel with a minimal change in support load. There are different styles and types depending on the manufacturers. Per MSS SP-58 a constant support hanger can be within specification and still have a load variation of plus minus 6% through the travel range.

Some suppliers claim a tighter tolerance on the load variation. Constant hangers and constant supports are used for piping and related components where higher levels of vertical travel occur. Their job is to transfer the working load over the whole travel area while maintaining constancy, i.e., without any considerable deviations. The functional precision of the constant hanger is decisive for the favorable long term behaviour of the components concerned.

Constant hangers compensate for vertical movement caused by thermal expansion. Via constant hangers, the respective piping loads are constantly absorbed and transferred with no significant deviation over the whole range of movement. *Significant deviations would act as harmful and uncontrolled extra loads in the system.*

Horizontal constant with top attachment which is bolted directly to the bottom of the steel as shown above.

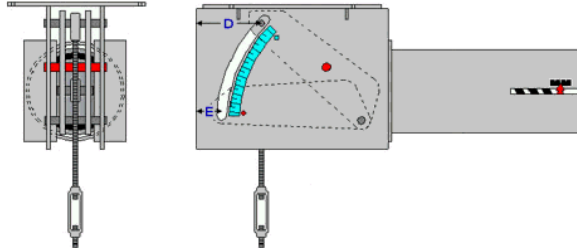

VARIABLE SPRING HANGERS AND SUPPORTS

A helical coil that supports dead weight load. The support load changes as the spring moves through its range at a specified spring rate. This support can be a hanger above the pipe, or a floor support below the pipe.

To prevent constraints in the system, thermal expansion in the piping and other piping components must not be hindered. The piping must therefore be supported in a correspondingly elastic manner.

To compensate for slight vertical displacements in the piping, spring components are used as supports. The functioning of these components is based on preset helical coil springs which exert a variable supporting load over the whole range of movement corresponding to the given spring characteristics.

Load variations resulting from this are limited through corresponding specifications based on stress calculations for the piping - this depends on the sensitivity of the system.

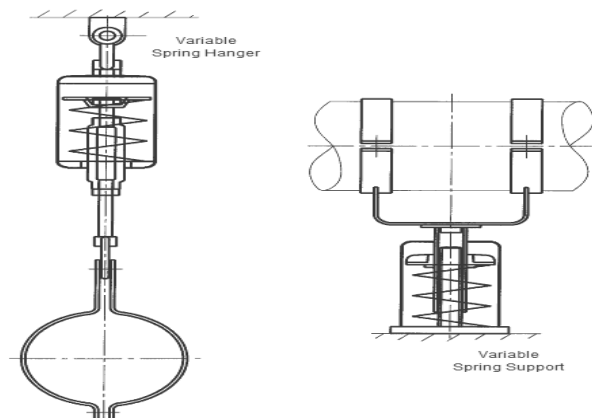

HYDRAULIC SHOCK ABSORBERS

The use of shock absorbers (snubbers) is preferred in thermally operating piping systems. In a dynamic event, shock absorbers instantaneously form a practically rigid restraint between the protected component and the structure. Resulting dynamic energy can at once be absorbed and harmlessly transferred.

Through the special function of the shock absorbers, thermal displacements during normal operation remain unhindered.

Hydraulic Shock Absorber (Snubber)



(Source: <http://wermac.org/steel/pipesupports.html>)

OVERVIEW OF STEEL INDUSTRY

India is currently the world's fourth largest producer of crude steel (knocking to be the third largest by the year end) and is expected to become the second largest producer by 2020. Steel production in India has increased from 81 million tonnes (mt) in 2013-14 to 88 mt in 2014-15 with the capacity being increased from 100 mt in 2013-14 to 110 mt in 2014-15. The steel sector contributes nearly 2% of the country's GDP and employs over 6 lakh people. The per capita consumption of total finished steel in the country has risen from 51 kg in 2009-10 to about 60 kg in 2014-15.

Steel industry derives its demand from other important sectors like infrastructure, aviation, engineering, construction, automobile, pipes and tubes etc. With the Indian economy poised for its next wave of growth under the reforms being unleashed in the last one year, there lies tremendous opportunity for the Indian steel industry to prosper and grow exponentially.

The Indian steel industry is largely iron-based through the blast furnace (BF) or the direct reduced iron (DRI) route. Indian steel industry is highly consolidated. About 50% of the crude steel capacity is resident with integrated steel producers (ISP). But the changing ratio of hot metal to crude steel production indicates toward the increasing presence of secondary steel producers in the eco-system.

(Source: http://www.indiasteelexpo.in/industry_overview.php)



Steel Production in India Has Been Growing At a Fast Pace

- In FY17, crude steel production in India was 97.42 MT, with the total crude steel production growing at a CAGR of 5.49 per cent over the last 6 years.
- The steel sector contributes over 2 per cent to the GDP of the nation and provides 20 lakh jobs in the country.
- During April-November 2017, crude steel and finished steel production in India stood at 66.70 MT and 76.356 MT respectively.
- As of March 2017, the capacity utilisation of steel producers is set to increase with strong export demand and signs of revival in domestic sales. Companies like JSW and Essar Steel have experienced a sharp increase in steel manufacturing in the last 2 months
- Steel manufacturing output of India is expected to increase to 128.6 MT by 2021, accelerating the country’s share of global steel production from 5.4 per cent in 2017 to 7.7 per cent by 2021.
- India’s steel output is expected to grow at a CAGR of 8.9 per cent during 2017-21 and India is expected to become top global steel producer^.

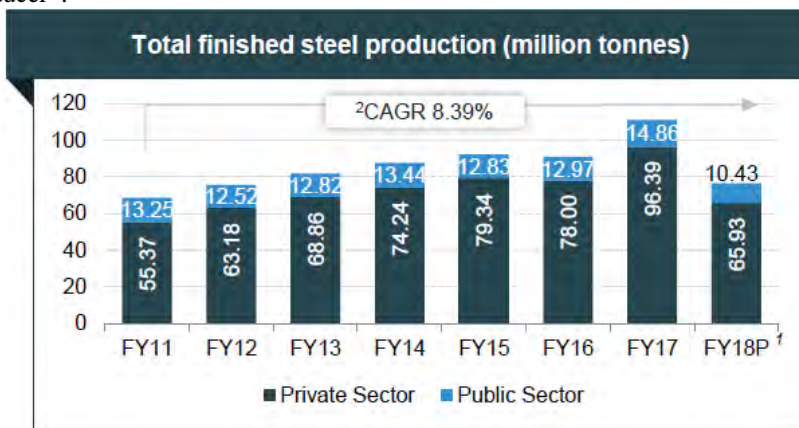

(Source: Steel Sectoral Report- December 2017 – ibef.org)

Government Initiatives

Some of the other recent government initiatives in this sector are as follows:

- Steel demand is set to rise in the coming period owing to increased public sector spending by the Government of India.
- The Union Cabinet, Government of India has approved the National Steel Policy (NSP) 2017, as it seeks to create a globally competitive steel industry in India. NSP 2017 targets 300 million tonnes (MT) steel-making capacity and 160 kgs per capita steel consumption by 2030.
- Metal Scrap Trade Corporation (MSTC) Limited and the Ministry of Steel have jointly launched an e-platform called 'MSTC Metal Mandi' under the 'Digital India' initiative, which will facilitate sale of finished and semi-finished steel products.
- The Ministry of Steel is facilitating setting up of an industry driven Steel Research and Technology Mission of India (SRTMI) in association with the public and private sector steel companies to spearhead research and development activities in the iron and steel industry at an initial corpus of Rs 200 crore (US\$ 30 million).

Road ahead

India is expected to overtake Japan to become the world's second largest steel producer soon, and aims to achieve 300 million tonnes of annual steel production by 2025-30.



India is expected to become the second largest steel producer in the world by 2018, based on increased capacity addition in anticipation of upcoming demand, and the new steel policy, that has been approved by the Union Cabinet in May 2017, is expected to boost India's steel production.* Huge scope for growth is offered by India's comparatively low per capita steel consumption and the expected rise in consumption due to increased infrastructure construction and the thriving automobile and railways sectors.

(Source: www.ibef.org)

FABRIC AND TEXTILE INDUSTRY OVERVIEW

Indian Scenario

India's textiles sector is one of the oldest industries in Indian economy dating back several centuries. Even today, textiles sector is one of the largest contributors to India's exports with approximately 13 per cent of total exports. The textiles industry is also labour intensive and is one of the largest employers. The textile industry has two broad segments. First, the unorganised sector consists of handloom, handicrafts and sericulture, which are operated on a small scale and through traditional tools and methods. The second is the organised sector consisting of spinning, apparel and garments segment which apply modern machinery and techniques such as economies of scale.

The textile industry employs about 45 million people directly and 20 million people indirectly. India's overall textile exports during FY 2015-16 stood at US\$ 40 billion.

Market Size

The Indian textiles industry, currently estimated at around US\$ 120 billion, is expected to reach US\$ 230 billion by 2020. The Indian Textile Industry contributes approximately 2 per cent to India's Gross Domestic Product (GDP), 10 per cent of manufacturing production and 14 per cent to overall Index of Industrial Production (IIP).

Indian khadi products sales increased by 33 per cent year-on-year to Rs 2,005 crore (US\$ 311.31 million) in 2016-17 and is expected to exceed Rs 5,000 crore (US\$ 776.33 million) sales target for 2018-19, as per the Khadi and Village Industries Commission (KVIC).

The total area under cultivation of cotton in India is expected to increase by 7 per cent to 11.3 million hectares in 2017-18, on account of expectations of better returns from rising prices and improved crop yields during the year 2016-17.

Government Initiatives

The Indian government has come up with a number of export promotion policies for the textiles sector. It has also allowed 100 per cent FDI in the Indian textiles sector under the automatic route.

Initiative will be taken into consideration by Government of India.

- The Government has planned to connect as many as 5 crore (50 million) village women to charkha (spinning wheel) in next 5 years with a view to provide them employment and promote khadi and also, they inaugurated 60 khadi outlets which were renovated and re-launched during the completion of KVIC's 60th anniversary and a khadi outlet.
- The Textiles Ministry will organise 'Hastkala Sahyog Shivirs' in 421 handloom-handicrafts clusters across the country which will benefit over 1.2 lakh weavers and artisans.
- The Gujarat government's decision to extend its textile policy by a year is set. It is believed to attract Rs 5,000 crore (US\$ 50 billion) of more investment in sectors across the value chain. The government estimates addition till now of a million units of spindle capacity in the spinning sector and setting up of over 1,000 units in technical textiles.



The key initiatives announced in the Union Budget 2017-18 to boost the textiles sector are listed below:

- Encourage new entrepreneurs to invest in sectors such as knitwear by increasing allocation of funds to Mudra Bank from Rs 1,36,000 crore (US\$ 20.4 billion) to Rs 2,44,000 crore (US\$ 36.6 billion).
- Upgrade labour skills by allocating Rs 2,200 crore (US\$ 330 million)

(Source: www.ibef.org)



SUMMARY OF OUR BUSINESS

Our Company manufactures and fabricates various steel products which are meant for its application in Pipe Support Systems, HVAC Systems, Anti-vibration System and Equipments for Industrial, Commercial, Utility and OEM Installations. We manufacture various engineering products, metal and base metal products like G. I. nuts, various types of bolts, clamps, hangers etc. Further our Product Portfolio includes all types of bathroom pipes, fittings, bathroom accessories and sanitary wares.

The following diagram depicts the breakup of revenue, percentage-wise for financial year ended March 31, 2018 on the basis of Manufacturing and Trading segments.

Revenue Model	
Manufacturing (61.22%) ⁽¹⁾	Trading (38.78%) ⁽¹⁾

⁽¹⁾Percentage (%) is calculated as a percentage of Total Sale of Products.

Certain products manufactured by us are certified by Underwriter's Laboratory Inc. (U.S.A) and FM Global Approved (U.S.A) which are meant to be used for Fire Sprinklers System Installations. Further, we are certified by Dun & Bradstreet which helps us in growing relationships through their global database and helps us in exploring the new potential customers.

We are certified by ISO 9001:2015 for manufacturing of various products i.e. UL and FM approved Pipe Hangers and Support Systems, Anti vibration products, Rubber support inserts, valves, S.S. Floor Drains. This certification confirms to the Quality Management System of our Company in relation to the manufacturing of various products.

Our Company has 3 manufacturing units located at Vasai. These manufacturing units are strategically located providing locational advantages. Our Company has installed various plant and machinery at our manufacturing facilities for manufacturing and fabrication of the varied products. For further details regarding machineries, please refer to "Our Business - Plant and Machinery" on page no. 108 of this Prospectus.

Our Company exports its products to various geographies such as USA and various countries in Middle East serving to various companies of several industries. We have a good customer base in India as well as internationally. These customers have been a part of the growth story of our Company which we believe is essentially due to the product quality and customer centric approach of our Company. We also have a good customer base in India for the products manufactured by us.

Our Company is even engaged in trading of textile products. We trade into fancy shirting and finish fabrics. Based on the orders received from our Customers for the textile products, we order the exact requirement from our suppliers and make the final product available to our Customers

Our revenue from operations for the financial year ending 2015-16, 2016-17 and 2017-18 are ₹ 4,668.77 lakhs, ₹ 5,132.56 lakhs and ₹ 6,182.36 respectively. Our Net Profit after tax for the above mentioned periods i.e. in the last 3 years are ₹ 77.02 lakhs in F. Y. 2015-16, ₹ 95.55 lakhs in F.Y. 2016-17 and ₹ 107.12 lakhs in F.Y. 2017-18. The above Net profit after tax shows an increase of 24.06% and 12.11% respectively over the 3 years.

OUR STRENGTHS

Well Experienced Management

Our Company is being led by Mr. Sanjay Patel, having an experience of 36 years. We have an experienced and professional management team with strong execution capabilities and considerable experience in this industry



We have employed suitable technical and support staff to manage key areas of activities allied to operations. Further our Company has entered into an agreement for supply of job workers wherein the labourers employed are skilled for the job. We believe the skill sets of our labourers give us the flexibility to adapt to the needs of our clients and help satisfy the technical requirements of the products that we manufacture.

Our team is well qualified and experienced in the engineering and steel industry and has been responsible for the growth of our operations. We believe the stability of our management team and the industry experience brought in by our KMPs and employees, coupled with their strong client relationships, will enable us to continue to take advantage of future market opportunities and expand into new markets. For further details of the educational qualifications and experience of our Management Team and our Key Managerial Personnel please refer the chapter titled “*Our Management*” beginning on page no. 128 of this Prospectus.

Compliance with Quality Standards & Consistency in Quality and Service

We follow stringent quality standards in all our manufacturing units to ensure that our products meet the required standards. Our products adhere to quality standards and our manufacturing units are ISO 9001:2015 certified, which confirms that our products conform to the Quality Management System Standard.

UL and FM Approved Product range meeting with International Standards

Our Company is certified by Underwriter’s Laboratory Inc. (U.S.A) and FM Global Approved (U.S.A), wherein we have received UL and FM Approvals from Directors of North American Certification Programs and from AVP, Manager-Fire Protection of FM Approvals respectively. These certifications provide a worldwide recognition for the Products approved by the Authorities.

The products manufactured by us should meet the industry standard set for their design and quality. We follow stringent measures to ensure the compliance of these standards for meeting the International norms. Regular audits are conducted at our premises to ensure the compliance of the parameters set.

Customized Product Development

Our Company offers customization facilities to all the customers as per their particular requirements and specifications. Our manufacturing teams focus on the precise demand of the customer and design the products accordingly. This provides complete satisfaction to our customers and enables us to expand our business from existing customers and also address a larger base of potential new customers

Strong Customer Base

Our Company exports its products to various geographies such as USA and various countries in Middle East serving to various companies of several industries. We have a good customer base in India as well as internationally which includes international Companies like Technopro Middle East FZCO, Hamat Alezz Trading Est., Bin Dasmal General Trading Co LLC., Al Sayed Center A/C & Refrigeration Materials etc. These customers have been a part of the growth story of our Company which we believe is essentially due to the product quality and customer centric approach of our Company. We also have a good customer base in India for the products manufactured by us.

Scalable Business Model

Our Business model is customer centric and order driven, and requires optimum utilisation of our existing facilities, assuring quality supply of raw materials and achieving consequent economies of scale. The business scale generation is basically due to development of new markets both domestic and international by exploring marketing expertise and by maintaining the consistent quality output. We believe that this business model has proved successful and scalable for our Company.



OUR STRATEGIES

Increase in Order-taking Appetite by augmenting our working capital base

Our business operations are working capital intensive. In order to effectively expand our products portfolio, Business arenas and also increase in number of verticals and explore various geographical locations, along with the existing facilities we need to have access to a larger amount of liquid funds and sufficient working capital.

We believe there is growing trend towards steel industry considering electrical and mechanicals installations. Alongwith the increasing demand, we expect to increase our order taking appetite thus increasing our volumes, revenues and scale of operations and we will require substantial working capital for the same. It is hence our strategy to raise funds from this issue and augment our fund based working capital capabilities. We believe that companies with high liquidity on their balance sheet would be able to better exploit market opportunities.

Hence, in order to effectively operate the aforementioned additional facilities along with the existing facilities we need to have access to a larger amount of liquid funds and sufficient working capital. For further details of the proposed working capital requirements of the company, kindly refer to the Chapter titled “*Objects of the Issue*” beginning on page no. 71 of this Prospectus.

Expansion of product range

We intend to continue to diversify our existing products by manufacturing various other products which are used in the application of Fire Fighting, plumbing and other mechanical installations. Presently, our Company is manufacturing and fabricating various steel products for Industrial, Commercial, Utility and OEM Installations. We manufacture various engineering products, metal and base metal products like G. I. nuts, various types of bolts, clamps, hangers etc.

Going forward, we intend to expand our current product portfolio and we intend to manufacture screws, nuts, bolts and washers in-house. This expansion in the Product portfolio will serve as a one-stop solution provider for engineering products meant to be used in Pipe Support Systems, HVAC Systems, Anti-vibration System and Equipments etc.

Expand our distribution network and exports

Our existing reach in international countries has been critical to our export sales. We also have a market in India for the goods manufactured by us. We aim to further develop our domestic sales networks in two ways: firstly nurturing existing relationships with clients and secondly by creating new distribution channels in non-penetrated geographies considering various cities.

As on March 31, 2018, about 58.11% of total business comes from export sales of manufactured products, 1.24% from local sales of manufactured goods and balance comes from trading of textile products. Our company is focusing on increasing growth in the export markets. Exports brings in better realization of margins, prompt delivery due to faster and planned pace of projects, better payment terms and access to larger markets. This also reduces the risk of dependence on a single market and ensures that any slowdown in the market would not affect overall growth and performance of our Company.

Optimal Utilization of Resources:

Our Company constantly endeavours to improve our manufacturing and fabrication process by using latest technology in machineries to optimize the utilization of resources. We regularly analyze our existing raw material procurement and manufacturing/ fabrication processes to identify the areas of bottlenecks and correct the same. This helps us in improving efficiency and putting resources to optimal use.



Strengthening our Brand

Our strategic objective is to increase the presence of our brand in the existing markets and positioning our brand in the future markets that we intend to capture. We intend to consequently improve our economic of scale whereby we can develop a brand expansion strategy that will help us to increase our market share of exports, business growth and profitability. Further, we shall also use the appropriate pricing strategy to persuade our existing and newer consumers to buy our branded products.

We intend to invest in developing and enhancing our brand image, through brand building efforts, communication and promotional initiatives such as advertisements in media, participation in industry events, exhibitions etc. This is a continuous exercise, which would increase the brand image resulting in an increase of sales and profitability.

Diversifying and increasing penetration in markets

Our Company's products are sold in domestic market and global market. The domestic market also offers opportunities in term of sub-geographic penetration and product/market diversification. Our Company will seek to grow its marketing reach domestically to explore hither to untapped markets and segments as part of its strategy to mitigate market risk and widen growth prospects. Our Company will continue to explore opportunities in various countries where it can supply value added products to enhance its geographical reach.

Enhancing production and product quality

We believe quality is an important factor when it comes to any product or service. With the high market competition, quality product at an affordable price has become the market differentiator for almost all products and services. We constantly work to enhance the existing quality of our products by optimizing the existing production processes and introducing new processes. We train our employees to consistently design and deliver client focused solutions.



SUMMARY OF FINANCIAL INFORMATION

STATEMENT OF ASSETS AND LIABILITIES, AS RESTATED

(₹ in lakhs)

Particulars	As at March 31,				
	2018	2017	2016	2015	2014
EQUITY AND LIABILITIES					
Shareholder's fund					
a) Equity Share Capital	390.00	200.00	200.00	200.00	50.00
b) Reserves and surplus	368.86	296.64	201.08	124.06	83.75
Share Application Money Pending Allotment	-	-	-	-	-
Total Shareholders Fund (Net of revaluation reserve)	758.86	496.64	401.08	324.06	133.75
Non-current liabilities					
a) Long Term Borrowings	506.69	202.32	98.61	78.68	116.85
Total	506.69	202.32	98.61	78.68	116.85
Current liabilities					
a) Short-term borrowings	1,288.38	737.52	754.36	557.30	440.75
b) Trade payables	918.08	676.62	227.54	737.06	738.80
c) Other Current Liabilities	245.26	276.35	37.33	95.15	112.63
d) Short-term provisions	-	56.33	43.10	20.31	8.03
Total	2,451.72	1,746.82	1,059.32	1,409.81	1,300.21
TOTAL	3,717.27	2,445.78	1,562.01	1,812.55	1,550.80
ASSETS					
Non - Current Assets					
a) Fixed Assets					
i) Tangible assets	-	-	-	-	-
Gross Block	630.12	498.00	349.03	242.51	220.61
Less: Accumulated Depreciation	204.42	146.49	87.55	49.59	30.96
Net Block	425.71	351.51	261.48	192.92	189.65
b) Non- Current Investments	-	-	-	100	-
c) Deferred Tax Assets	11.17	15.21	7.37	2.94	0.99
d) Long term Loans & Advances	15.57	10.52	11.15	9.85	16.83
e) Other Non Current Assets	27.04	-	-	0.08	0.15
Total	479.48	377.24	280.00	305.79	207.62
Current Assets					
a) Inventories	698.45	486.60	100.98	176.23	251.13
b) Trade Receivables	2,104.51	1,376.77	966.51	1,060.02	762.54
c) Cash and Cash equivalents	119.83	52.10	32.20	8.38	2.70
d) Short-term loans and advances	308.52	2.08	47.83	170.67	291.21
e) Other Current Assets	6.46	150.99	134.49	91.46	35.60
Total	3,237.79	2,068.54	1,282.00	1,506.76	1,343.18
TOTAL	3,717.27	2,445.78	1,562.01	1,812.55	1,550.80



STATEMENT OF PROFIT AND LOSS ACCOUNT, AS RESTATED

(₹ in lakhs)

Particulars	For the year ended March 31,				
	2018	2017	2016	2015	2014
INCOME:					
Revenue from Operations	6,182.36	5,132.56	4,668.77	3,748.30	3,320.96
Other Income	17.40	7.90	3.34	1.14	0.19
Total income (A)	6,199.76	5,140.47	4,672.11	3,749.45	3,321.15
EXPENSES:					
Cost of materials consumed	4,722.19	4,855.78	4,162.29	3,408.31	3,288.11
(Increase)/ Decrease in Inventories	(396.27)	(385.62)	75.25	74.91	(160.02)
Employee benefits expense	149.58	112.94	75.83	40.42	29.30
Finance cost	189.50	142.65	102.03	88.28	68.93
Depreciation and amortization expense	57.93	58.94	37.96	18.63	13.26
Administration and other expenses	1,321.76	213.80	105.86	61.43	62.64
Total expenses (B)	6,044.68	4,998.49	4,559.22	3,691.98	3,302.22
Profit before extraordinary items and tax (C)	155.07	141.97	112.88	57.47	18.93
Prior period items (Net)	-	-	-	-	-
Profit before exceptional, extraordinary items and tax (A-B)	155.07	141.97	112.88	57.47	18.93
Exceptional items	-	-	-	-	-
Profit before extraordinary items and tax	155.07	141.97	112.88	57.47	18.93
Extraordinary items	-	-	-	-	-
Profit before tax (D)	155.07	141.97	112.88	57.47	18.93
<i>Tax expense :</i>					
(i) Current tax	52.00	54.26	40.29	19.11	6.37
(ii) Deferred Tax	(4.05)	(7.84)	(4.43)	(1.95)	(0.76)
Total Tax Expense (E)	47.95	46.42	35.87	17.15	5.62
Profit for the year (D-E)	107.12	95.55	77.02	40.31	13.31



CASH FLOW STATEMENT, AS RESTATED

(₹ in lakhs)

Particulars	As at March 31,				
	2018	2017	2016	2015	2014
Cash flow from operating activities:					
Net Profit before tax as per Profit And Loss A/c	155.07	141.97	112.88	57.47	18.93
Adjusted for:					
Depreciation & amortization	57.93	58.94	37.96	18.63	13.26
Interest & Finance Cost	189.50	142.65	102.03	88.28	68.93
Operating Profit Before Working Capital Changes	402.50	343.56	252.87	164.38	101.12
Adjusted for (Increase)/ Decrease:					
Trade Receivables	(727.74)	(410.27)	93.51	(297.48)	(361.54)
Inventories	(211.86)	(385.62)	75.25	74.91	(160.02)
Short Term Loans and Advances	(306.45)	45.75	122.84	120.53	(174.89)
Other Current Assets	144.53	(16.50)	(43.04)	(55.86)	(14.59)
Other Non- current Assets	(27.04)	-	0.08	0.08	0.08
Long Term Loans and Advances	(5.05)	0.63	(1.30)	6.98	(3.67)
Trade Payables	241.45	449.08	(509.52)	(1.74)	478.88
Other Current Liabilities	(31.09)	239.02	(57.82)	(17.49)	104.99
Short Term Provisions	(49.12)	13.24	22.79	12.28	0.87
Cash Generated From Operations Before Extra-Ordinary Items	(569.86)	278.92	(44.33)	6.59	(28.76)
Add:- Extra-Ordinary Items	-	-	-	-	-
Cash Generated From Operations	(569.86)	278.90	(44.33)	6.59	(28.76)
Direct Tax Paid	52.00	54.26	40.29	19.11	6.37
Net Cash Flow from/(used in) Operating Activities:(A)	(621.86)	224.64	(84.62)	(12.52)	(35.13)
Cash Flow From Investing Activities:					
Purchase of Fixed Assets	(132.13)	(148.97)	(106.52)	(21.90)	(7.58)
(Increase) / Decrease in Non Current Investments	-	-	100.00	(100.00)	-
Net Cash Flow from/(used in) Investing Activities: (B)	(132.13)	(148.97)	(6.52)	(121.90)	(7.58)
Cash Flow from Financing Activities:					
Proceeds From Share Capital	60.00	-	-	150.00	
Increase / (Decrease) Long Term Borrowing	304.37	103.72	19.93	(38.17)	(52.05)
Increase / (Decrease) in Short Term Borrowing	550.86	(16.84)	197.06	116.55	163.48
Interest & Financial Charges paid	(189.50)	(142.65)	(102.03)	(88.28)	(68.93)
Proceeds From Securities Premium Account	96.00	-	-	-	-
Net Cash Flow from/(used in) Financing Activities (C)	821.74	(55.77)	114.96	140.10	42.50
Net Increase/(Decrease) in Cash & Cash Equivalents (A+B+C)	67.75	19.90	23.82	5.68	(0.21)
Cash & Cash Equivalents As At Beginning of the Year	52.10	32.20	8.38	2.70	2.91
Cash & Cash Equivalents As At End of the Year	119.85	52.10	32.20	8.38	2.70

Note: The cash flow statement has been prepared on the basis of restated statement of profit & loss and balance sheet.



THE ISSUE

PRESENT ISSUE IN TERMS OF THIS PROSPECTUS

Equity Shares: Present Issue of Equity Shares by our Company	13,68,000 Equity Shares of ₹ 10 each for cash at a price ₹ 69/- per share aggregating ₹ 943.92 lakhs.
Consisting of:	
Fresh Issue	11,23,000 Equity Shares of ₹ 10 each for cash at a price of ₹ 69/- per share aggregating ₹ 774.87 lakhs
Offer for Sale to the Public⁽¹⁾	2,45,000 Equity Shares of ₹ 10 each for cash at a price of ₹ 69/- per share aggregating ₹ 169.05 lakhs
Of which:	
Issue Reserved for the Market Makers	72,000 Equity Shares of ₹ 10 each for cash at a price of ₹ 69/- per share aggregating ₹ 49.68 lakhs
Net Issue to the Public	12,96,000 Equity Shares of ₹ 10 each for cash at a price of ₹ 69/- per share aggregating ₹ 894.24 lakhs
	<i>Of Which:</i>
	6,48,000 Equity Shares of ₹ 10 each at a price of ₹ 69/- per Equity Share will be available for allocation for Investors of up to ₹ 2 lakhs
	6,48,000 Equity Shares of ₹ 10 each at a price of ₹ 69/- per Equity Share will be available for allocation for Investors of above ₹ 2 lakhs
Equity Shares outstanding prior to the Issue	39,00,000 Equity Shares
Equity Shares outstanding after the Issue	50,23,000 Equity Shares
Objects of the Issue	Please see the chapter titled “ <i>Objects of the Issue</i> ” beginning on page no. 71 of this Prospectus

This issue is being made in terms of Chapter XB of the SEBI (ICDR) Regulations, 2009, as amended from time to time. For further details, please see the section titled “Issue Related Information” beginning on page no. 216 of this Prospectus.

The present Issue has been authorized pursuant to a resolution of our Board dated March 20, 2018 and by Special Resolution passed under Section 62(1)(c) of the Companies Act, 2013 at an Extra-Ordinary General Meeting of our shareholders held with shorter notice on March 22, 2018.

⁽¹⁾ *The Offer for Sale has been authorised by Mr. Piyush J Patel (“Selling Shareholder”) by his consent letter dated March 19, 2018 to offer 2,45,000 Equity Shares.*

The Selling Shareholder have confirmed that the Equity Shares proposed to be offered and sold in the Issue are eligible in term of SEBI (ICDR) Regulations and that they have not been prohibited from dealings in securities market and the Equity Shares offered and sold are free from any lien, encumbrance or third party rights. The Selling Shareholder has also confirmed that he is the legal and beneficial owner of the Equity Shares being offered by him under the Offer for Sale.



GENERAL INFORMATION

Our Company was incorporated as Saketh Exim Private Limited on June 16, 2010 under the Companies Act, 1956 with the Registrar of Companies, Mumbai bearing Registration No. 204331. Subsequently, the status of our Company was changed to a public limited company and the name of our Company was changed to Saketh Exim Limited vide Special Resolution dated December 07, 2017. A fresh certificate of incorporation consequent upon conversion was granted to our Company on December 19, 2017, by the Registrar of Companies, Mumbai. The Corporate Identity Number of our Company is U29253MH2010PLC204331.

For further details, please refer to the chapter titled “*History and Certain Corporate Affairs*” beginning on page no. 124 of this Prospectus.

Brief Company and Issue Information

Registered Office	Address: Plot No- PAP D-146/147, TTC MIDC, Turbhe, Navi Mumbai - 400705 Tel No: +91 22 2762 0641 /42 /43 Fax No: +91 22 2762 0623 Email: info@sakethexim.com Website: www.sakethexim.com
Date of Incorporation	June 16, 2010
Company Registration No.	204331
Company Identification No.	U29253MH2010PLC204331
Address of Registrar of Companies	Everest, 100, Marine Drive, Mumbai – 400 002. Tel No.: +91 22 2281 2627/ 2202 0295 /2284 6954 Fax No.: +91 22 2281 1977
Designated Stock Exchange	EMERGE Platform of National Stock Exchange of India Limited
Company Secretary & Compliance Officer	Ms. Neelam Pathak Address: Plot No- PAP D-146/147, TTC MIDC, Turbhe, Navi Mumbai - 400705 Tel No: +91 22 2762 0641 /42 /43 Fax No: +91 22 2762 0623 Email: cs@sakethexim.com Website: www.sakethexim.com

Board of Directors of our Company

The following table sets forth the Board of Directors of our Company:

Name	Designation	Director's Identification No.
Mr. Sanjay J Patel	Managing Director	01958033
Mrs. Smita S Patel	Chairman and Non-Executive Non-Independent Director	00348305
Mrs. Taruna P Patel	Non-Executive Non-Independent Director	00348453
Mr. Jasbir Singh Anand	Non- Executive Independent Director	08017248
Mr. Jehan D Variava	Non- Executive Independent Director	07825744

For further details pertaining to the educational qualification and experience of our Directors, for details please refer to the chapter titled “*Our Management*” beginning on page no. 128 of this Prospectus.

Note: Investors can contact the Compliance Officer or the Registrar to the Issue in case of any pre or post-offer related problems, such as non-receipt of letters of allotment, credit of allotted shares in the respective beneficiary account and unblocking of funds. All grievances relating to the Application process may be addressed to the



Registrar to the Issue with a copy to the SCSBs, giving full details such as name, address of Applicant, application number, number of Equity Shares applied for, amount blocked on application and designated branch or the collection centre of the SCSB/ Designated Intermediary, where the Application Form was submitted by the Applicants.

Details of Key Intermediaries pertaining to this Issue and Our Company

LEAD MANAGER TO THE ISSUE



ARYAMAN FINANCIAL SERVICES LIMITED

60, Khatau Building, Ground Floor, Alkesh Dinesh Modi Marg

Opp. P.J. Tower (BSE Building), Fort, Mumbai - 400 001

Tel. No.: +91 22 6216 6999

Fax No.: +91 22 2263 0434

Website: www.afsl.co.in

Email: ipo@afsl.co.in

Investor Grievance Email: feedback@afsl.co.in

Contact Person: Mrs. Jyothi Shetty / Ms. Hiral Motani

SEBI Registration No.: INM000011344

REGISTRAR TO THE ISSUE



BIGSHARE SERVICES PRIVATE LIMITED

1st Floor, Bharat Tin Works Building, Opp. Vasant Oasis

Makwana Road, Marol, Andheri (East), Mumbai – 400 059

Tel. No.: +91 22 6263 8200

Fax No.: +91 22 6263 8299

Email: ipo@bigshareonline.com

Investor Grievance Email: investor@bigshareonline.com

Website: www.bigshareonline.com

Contact Person: Mr. Jibu John

SEBI Registration No.: INR000001385

LEGAL COUNSEL TO THE ISSUE



KANGA & CO. (ADVOCATES & SOLICITORS)

Readymoney Mansion, 43

Veer Nariman Road, Mumbai – 400 001

Tel No.: +91 22 6623 0000 / 2288

Fax No.: +91 22 6633 9656 / 57

Contact Person: Mr. Chetan Thakkar

Email: chetan.thakkar@kangacompany.com

Website: www.kangacompany.com

STATUTORY AUDITOR OF THE COMPANY / PEER REVIEW AUDITOR OF THE COMPANY

R A Maru & Associates

C/4, Khandwala Apartments CHSL, Vakola Pipe Lines

Gaodevi, Snataacruz (East), Mumbai - 400055

Tel No.: +91 22 2268 0488

Email: carumeetmaru@gmail.com

Contact Person: Mr. Rumeet A Maru



BANKERS TO OUR COMPANY



Bank of India

T.K. Joshi Road, Turbhe Branch, Plot No. 34

Sector 24, Turbhe, Navi Mumbai – 400705

Tel No.: +91 22 2783 3359

Fax No.: +91 22 2783 1143

Contact Person: Mr. Hanwant Kumar Thakur

Email: Turbhe.Navimumbai@bankofindia.co.in

Website: www.bankofindia.co.in



Small Industries Development Bank of India

SIDBI Tower, 15, Ashok Marg, Lucknow - 226001

Tel No.: +91 22 2582 6616

Fax No.: +91 22 2582 2109

Website: www.sidbi.in

Email: ncdas@sidbi.in

Contact Person: Mr. Nirmal Chandra Das

BANKERS TO THE ISSUE



AXIS BANK LIMITED

Jeevan Prakash Building

Sir P.M. Road, Fort, Mumbai – 400 001

Tel No.: +91 22 4086 7336 / 7474

Fax No.: +91 22 4086 7327 / 7378

Website: www.axisbank.com

Email: fort.operationshead@axisbank.com

Contact Person: Mr. Sudhir Rajee

SEBI Registration No.: INBI00000017

SELF CERTIFIED SYNDICATE BANKS

The lists of Banks that have been notified by SEBI to act as SCSBs for the ASBA process are provided on <http://www.sebi.gov.in>. For details on designated branches of SCSBs collecting the ASBA Application Forms, please see the above mentioned SEBI link.

BROKERS TO THIS ISSUE

The list of the Registered Brokers, including details such as postal address, telephone number and e-mail address, is provided on the website of the Stock Exchange, at National Stock Exchange of India Limited, as updated from time to time.

REGISTRAR TO ISSUE AND SHARE TRANSFER AGENTS

The list of the RTAs eligible to accept Applications forms at the Designated RTA Locations, including details such as address, telephone number and e-mail address, are provided on the website of Stock Exchange at National Stock Exchange of India Limited, as updated from time to time.

COLLECTING DEPOSITORY PARTICIPANTS

The list of the CDPs eligible to accept Application Forms at the Designated CDP Locations, including details such as name and contact details, are provided on the website of Stock Exchange at National Stock Exchange of India Limited, as updated from time to time.



The list of branches of the SCSBs named by the respective SCSBs to receive deposits of the Application Forms from the Designated Intermediaries will be available on the website of the SEBI (www.sebi.gov.in) and updated from time to time.

INTER-SE ALLOCATION OF RESPONSIBILITIES

Aryaman Financial Services Limited is the Sole Lead Manager to this Issue, and hence is responsible for all the Issue management related activities.

MONITORING AGENCY

As per Regulation 16(1) of the SEBI (ICDR) Regulations, 2009 the requirement of Monitoring Agency is not mandatory if the fresh issue size is below ₹ 10,000 lakhs and hence our Company has not appointed a monitoring agency for this issue.

Pursuant to Regulation 32(3) of the SEBI (LODR) Regulations, 2015, our Company shall on a half yearly basis disclose to the Audit Committee the uses and application of the Net Proceeds. Until such time as any part of the Net Proceeds remains unutilized, our Company will disclose the utilization of the Net Proceeds under separate heads in our Company's balance sheet(s) clearly specifying the amount of and purpose for which Net Proceeds have been utilized so far, and details of amounts out of the Net Proceeds that have not been utilized so far, also indicating interim investments, if any, of such unutilized Net Proceeds. In the event that our Company is unable to utilize the entire amount that we have currently estimated for use out of the Net Proceeds in a fiscal, we will utilize such unutilized amount in the next fiscal.

Further, in accordance with Regulation 32(1)(a) of the SEBI (LODR) Regulations, 2015, our Company shall furnish to the Stock Exchanges on a half yearly basis, a statement indicating material deviations, if any, in the utilization of the Net Proceeds for the objects stated in this Prospectus.

IPO GRADING

No credit rating agency registered with SEBI has been appointed for grading the Issue.

TRUSTEES

This being an Issue of Equity Shares, the appointment of trustees is not required.

DETAILS OF THE APPRAISING AUTHORITY

The objects of the Issue and deployment of funds are not appraised by any independent agency/ bank/ financial institution.

CREDIT RATING

This being an Issue of Equity Shares, no credit rating is required.

EXPERT OPINION

Except as stated below, our Company has not obtained any expert opinions:

Our Company has received written consent from the Statutory & Peer Review Auditor namely, M/s. R A Maru & Associates, Chartered Accountants to include its name as required under section 26(1)(a)(v) of the Companies Act, 2013 in this Prospectus and as "Expert" as defined under section 2(38) of the Companies Act, 2013 in respect of the



reports on the Restated Financial Statements dated July 14, 2018 and the Statement of Tax Benefits dated July 14, 2018, issued by them respectively, included in this Prospectus and such consents has not been withdrawn as on the date of this Prospectus. However, the term “expert” shall not be construed to mean an “expert” as defined under the U.S. Securities Act.

ISSUE PROGRAMME

An indicative timetable in respect of the Issue is set out below:

Event	Indicative Date
Issue Opening Date	August 01, 2018
Issue Closing Date	August 03, 2018
Finalisation of Basis of Allotment with the Designated Stock Exchange	August 08, 2018
Initiation of Allotment / Refunds / Unblocking of Funds	August 09, 2018
Credit of Equity Shares to demat accounts of Allottees	August 10, 2018
Commencement of trading of the Equity Shares on the Stock Exchange	August 13, 2018

The above timetable is indicative and does not constitute any obligation on our Company, the Selling Shareholder or the Lead Manager. Whilst our Company shall ensure that all steps for the completion of the necessary formalities for the listing and the commencement of trading of the Equity Shares on the Stock Exchange are taken within 6 Working Days of the Issue Closing Date, the timetable may change due to various factors, such as extension of the Issue Period by our Company, or any delays in receiving the final listing and trading approval from the Stock Exchange. The Commencement of trading of the Equity Shares will be entirely at the discretion of the Stock Exchange and in accordance with the applicable laws.

Applications and any revision to the same shall be accepted **only between 10.00 a.m. and 5.00 p.m.** (IST) during the Issue Period (except for the Issue Closing Date). On the Issue Closing Date, the Applications and any revision to the same shall be accepted between **10.00 a.m. and 3.00 p.m.** (IST) or such extended time as permitted by the Stock Exchanges, in case of Applications by Retail Individual Applicants after taking into account the total number of applications received up to the closure of timings and reported by the Lead Manager to the Stock Exchanges. It is clarified that Applications not uploaded on the electronic system would be rejected. Applications will be accepted only on Working Days, i.e., Monday to Friday (excluding any public holiday).

Due to limitation of time available for uploading the Applications on the Issue Closing Date, the Applicants are advised to submit their Applications one day prior to the Issue Closing Date and in any case, no later than 3.00 p.m. (IST) on the Issue Closing Date. All times mentioned in this Prospectus are Indian Standard Times. Applicants are cautioned that in the event a large number of Applications are received on the Issue Closing Date, as is typically experienced in public issuing, some Applications may not get uploaded due to lack of sufficient time. Such Applications that cannot be uploaded will not be considered for allocation under the Issue. Applications will be accepted only on Business Days. Neither our Company nor the Lead Manager nor the Selling Shareholder is liable for any failure in uploading the Applications due to faults in any software/hardware system or otherwise.

In accordance with the SEBI Regulations, QIBs and Non-Institutional Applicants are not allowed to withdraw or lower the size of their Applications (in terms of the quantity of the Equity Shares or the Applications Amount) at any stage. Retail Individual Applicants can revise or withdraw their Applications prior to the Issue Closing Date. Except Allocation to Retail Individual Investors, Allocation in the Issue will be on a proportionate basis.

In case of discrepancy in the data entered in the electronic book vis-a-vis the data contained in the physical Application Form, for a particular Applicant, the details as per the file received from the Stock Exchange may be taken as the final data for the purpose of Allotment. In case of discrepancy in the data entered in the electronic book vis-a-vis the data contained in the physical or electronic Application Form, for a particular ASBA Applicant, the



Registrar to the Issue shall ask the relevant SCSBs / RTAs / DPs / Stock Brokers, as the case may be, for rectified data.

UNDERWRITING

This Issue is 100% Underwritten. Our Company and the Selling Shareholder have entered into an Underwriting Agreement dated March 22, 2018 and addendum dated June 12, 2018 with the Underwriters for the Equity Shares proposed to be issued through the Issue. Pursuant to the terms of the Underwriting Agreement, the obligations of the Underwriters are several and are subject to certain conditions specified therein. The Underwriters have given their consent for inclusion of their name in the Draft Prospectus/Prospectus as Underwriters and have indicated their intention to underwrite the following number of specified securities being issued through this Issue:

Details of the Underwriter	No. of Shares Underwritten	Amt Underwritten (₹ in lakhs)	% of the Total Issue Size Underwritten
Aryaman Financial Services Limited 60, Khatau Building, Ground Floor Alkesh Dinesh Modi Marg Opp. P.J. Tower (BSE Building) Fort, Mumbai 400 001 Tel. No.: +91 22 6216 6999 Fax No.: +91 22 2263 0434 Email: ipo@afsl.co.in	12,96,000	894.24	94.74%
Aryaman Capital Markets Limited 60, Khatau Building, Ground Floor Alkesh Dinesh Modi Marg Opp. P.J. Tower (BSE Building) Fort, Mumbai 400 001 Tel. No.: +91 22 6216 6999 Fax No.: +91 22 2263 0434 Email: aryacapm@gmail.com	72,000	49.68	5.26%
Total	13,68,000	943.92	100.00%

As per Regulation 106 P (2) of SEBI (ICDR) Regulations, 2009, the Lead Manager has agreed to underwrite to a minimum extent of 15 % of the Issue out of its own account.

In the opinion of the Board of Directors, the resources of the above mentioned Underwriters are sufficient to enable them to discharge their respective underwriting obligations in full. The above – mentioned Underwriters are registered with SEBI under Section 12(1) of the SEBI Act or registered as broker with the Stock Exchange.

WITHDRAWAL OF THE ISSUE

Our Company and the Selling Shareholder, in consultation with the Lead Manager, reserves the right not to proceed with the Issue at any time after the Issue Opening Date but before the Board meeting for Allotment. In such an event our Company would issue a public notice in the newspapers, in which the pre-issue advertisements were published, within two days of the Issue Closing Date or such other time as may be prescribed by SEBI, providing reasons for not proceeding with the Issue. The Lead Manager, through the Registrar to the Issue, shall notify the SCSBs to unblock the bank accounts of the ASBA Applicants within one day of receipt of such notification. Our Company and the Selling Shareholder shall also promptly inform the Stock Exchange on which the Equity Shares were proposed to be listed. Notwithstanding the foregoing, the Issue is also subject to obtaining the final listing and trading approvals of the Stock Exchange, which our Company shall apply for after Allotment. If our Company and the Selling Shareholder withdraws the Issue after the Issue Closing Date and thereafter determines that it will proceed with an IPO, our Company shall be required to file a fresh Draft Prospectus.



MARKET MAKER



Aryaman Capital Markets Ltd.

60, Khatau Building, Ground Floor, Alkesh Dinesh Modi Marg

Opp. P.J. Tower (BSE Building), Fort, Mumbai 400 001

Tel. No.: +91 22 6216 6999

Fax No.: +91 22 2263 0434

Email: aryacapm@gmail.com

Contact Person: Mr. Harshad Dhanawade

SEBI Registration No.: INZ000004739

Market Maker Reg. No.: SMEMM0651421122012

Details of the Market Making Arrangement for this Issue.

Our Company and the Lead Manager, Aryaman Financial Services Limited have entered into an agreement dated March 22, 2018 and addendum dated June 12, 2018 with Aryaman Capital Markets Ltd., a Market Maker registered with the EMERGE Platform of NSE in order to fulfil the obligations of Market Making.

The Market Maker shall fulfil the applicable obligations and conditions as specified in the SEBI (ICDR) Regulations, and its amendments from time to time and the circulars issued by the NSE and SEBI regarding this matter from time to time.

Following is a summary of the key details pertaining to the Market Making arrangement:

1. The Market Maker shall be required to provide a 2-way quote for 75% of the time in a day. The same shall be monitored by the Stock Exchange. Further, the Market Maker shall inform the exchange in advance for each and every black out period when the quotes are not being offered by the Market Maker.
2. The minimum depth of the quote shall be ₹ 1,00,000. However, the investors with holdings of value less than ₹ 1,00,000 shall be allowed to issue their holding to the Market Maker in that scrip provided that he sells his entire holding in that scrip in one lot along with a declaration to the effect to the selling broker.
3. The Inventory Management and Buying/Selling Quotations and its mechanism shall be as per the relevant circulars issued by SEBI and EMERGE Platform of NSE from time to time.
4. Execution of the order at the quoted price and quantity must be guaranteed by the Market Maker, for the quotes given by him.
5. There would not be more than five Market Makers for a scrip at any point of time and the Market Makers may compete with other Market Makers for better quotes to the investors.
6. The shares of the company will be traded in continuous trading session from the time and day the company gets listed on EMERGE Platform of NSE and Market Maker will remain present as per the guidelines mentioned under NSE and SEBI circulars.
7. There will be special circumstances under which the Market Maker may be allowed to withdraw temporarily/fully from the market – for instance due to system problems or any other problems. All controllable reasons require prior approval from the Exchange, while force-majeure will be applicable for non controllable reasons. The decision of the Exchange for deciding controllable and non-controllable reasons would be final.



8. The Market Maker shall have the right to terminate said arrangement by giving a three months notice or on mutually acceptable terms to the Lead Manager, who shall then be responsible to appoint a replacement Market Maker.

In case of termination of the above mentioned Market Making Agreement prior to the completion of the compulsory Market Making period, it shall be the responsibility of the Lead Manager to arrange for another Market Maker in replacement during the term of the notice period being served by the Market Maker but prior to the date of releasing the existing Market Maker from its duties in order to ensure compliance with the requirements of regulation 106V of the SEBI (ICDR) Regulations, 2009. Further the Company and the Lead Manager reserve the right to appoint other Market Makers either as a replacement of the current Market Maker or as an additional Market Maker subject to the total number of Designated Market Makers does not exceed five or as specified by the relevant laws and regulations applicable at that particular point of time.

9. **Risk containment measures and monitoring for Market Maker:** EMERGE Platform of NSE will have all margins which are applicable on the NSE Main Board viz., Mark-to-Market, Value-At-Risk (VAR) Margin, Extreme Loss Margin, Special Margins and Base Minimum Capital etc. NSE can impose any other margins as deemed necessary from time-to-time.
10. **Punitive Action in case of default by Market Maker:** EMERGE Platform of NSE will monitor the obligations on a real time basis and punitive action will be initiated for any exceptions and/or non-compliances. Penalties / fines may be imposed by the Exchange on the Market Maker, in case he is not able to provide the desired liquidity in a particular security as per the specified guidelines. These penalties / fines will be set by the Exchange from time to time. The Exchange will impose a penalty on the Market Maker in case he is not present in the market (offering two way quotes) for at least 75% of the time. The nature of the penalty will be monetary as well as suspension in market making activities / trading membership.

The Department of Surveillance and Supervision of the Exchange would decide and publish the penalties / fines / suspension for any type of misconduct/ manipulation/ other irregularities by the Market Maker from time to time.

11. The price band shall be 20% and the market maker spread (difference between the sell and the buy quote) shall be within 10% or as intimated by Exchange from time to time.
12. Pursuant to SEBI Circular number CIR/MRD/DSA/31/2012 dated November 27, 2012, limits on the upper side for Markets Makers during market making process has been made applicable, based on the issue size and as follows:

Issue Size	Buy quote exemption threshold (including mandatory initial inventory of 5% of the Issue Size)	Re-Entry threshold for buy quote (including mandatory initial inventory of 5% of the Issue Size)
Up to ₹ 20 Crore	25%	24%
₹ 20 Crore to ₹ 50 Crore	20%	19%
₹ 50 Crore to ₹ 80 Crore	15%	14%
Above ₹ 80 Crore	12%	11%

All the above mentioned conditions and systems regarding the Market Making Arrangement are subject to change based on changes or additional regulations and guidelines from SEBI and Stock Exchange from time to time.



CAPITAL STRUCTURE

The share capital of the Company as on the date of this Prospectus is set forth below:

(₹ in lakhs, except share data)

Sr. No.	Particulars	Aggregate Value at Nominal Value	Aggregate Value at Issue Price
A	Authorised Share Capital		
	55,00,000 Equity Shares of face value of ₹ 10 each	550.00	-
B	Issued, Subscribed and Paid-up Share Capital before the Issue		
	39,00,000 Equity Shares of face value of ₹ 10 each	390.00	-
C	Present Issue in terms of this Prospectus⁽¹⁾		
	Issue of 13,68,000 Equity Shares of ₹ 10 each at a price of ₹ 69/- per equity Share	136.80	943.92
	Consisting of:		
	Fresh Issue of 11,23,000 Equity Shares of ₹ 10 each for cash at a price of ₹ 69/- per share	112.30	774.87
	Offer for Sale of 2,45,000 Equity Shares of ₹ 10 each for cash at a price of ₹ 69/- per share	24.50	169.05
	Which comprises of:		
	72,000 Equity Shares of ₹ 10 each at a price of ₹ 69/- per Equity Share reserved as Market Maker Portion	7.20	49.68
	Net Issue to Public of 12,96,000 Equity Shares of ₹ 10 each at a price of ₹ 69/- Equity Share to the Public	129.60	894.24
	Of which:		
	6,48,000 Equity Shares of ₹ 10 each at a price of ₹ 69/- per Equity Share will be available for allocation for Investors of up to ₹ 2 lakhs	64.80	447.12
	6,48,000 Equity Shares of ₹ 10 each at a price of ₹ 69/- per Equity Share will be available for allocation for Investors of above ₹ 2 lakhs	64.80	447.12
D	Equity Share Capital after the Issue		
	50,23,000 Equity Shares of ₹ 10 each		502.30
E	Securities Premium Account		
	Before the Issue (as on date of this Prospectus)		19.01
	After the Issue		681.58

⁽¹⁾ The present Issue has been authorized pursuant to a resolution of our Board dated March 20, 2018 and by Special Resolution passed under Section 62(1)(c) of the Companies Act, 2013 at an Extra-Ordinary General Meeting of our shareholders held with a shorter notice on March 22, 2018.

⁽²⁾ The Offer for Sale has been authorised by Mr. Piyush J Patel (“Selling Shareholder”) by his consent letter dated March 19, 2018 to offer 2,45,000 Equity Shares.



The Selling Shareholder have confirmed that the Equity Shares proposed to be Issued and sold in this Issue are eligible in term of SEBI (ICDR) Regulations and that they have not been prohibited from dealings in securities market and the Equity Shares Issued and sold are free from any lien, encumbrance or third party rights. The Selling Shareholder have also confirmed that they are the legal and beneficial owners of the Equity Shares being offered by him under the Offer for Sale.

Our Company has no outstanding convertible instruments as on the date of this Prospectus.

Changes in Authorized Share Capital

Since incorporation, the capital structure of our Company has been altered in the following manner:

1. The initial authorised share capital of ₹ 1,00,000 divided into 10,000 Equity Shares of ₹ 10 each was increased to ₹ 50,00,000 divided into 5,00,000 Equity Shares of ₹ 10 each, pursuant to resolution of shareholders passed at the EGM held on July 06, 2011.
2. The authorised share capital of ₹ 50,00,000 divided into 5,00,000 equity shares of ₹ 10 each was increased to ₹ 2,00,00,000 divided into 20,00,000 equity shares of ₹ 10 each, pursuant to resolution of shareholders passed at the EGM held on March 02, 2015.
3. The authorised share capital of ₹ 2,00,00,000 divided into 20,00,000 equity shares of ₹ 10 each was increased to ₹ 3,50,00,000 divided into 35,00,000 equity shares of ₹ 10 each, pursuant to resolution of shareholders passed at the AGM held on September 29, 2017.
4. The authorised share capital of ₹ 3,50,00,000 divided into 35,00,000 equity shares of ₹ 10 each was increased to ₹ 5,50,00,000 divided into 55,00,000 equity shares of ₹ 10 each, pursuant to resolution of shareholders passed at the EGM held on March 12, 2018.

NOTES TO THE CAPITAL STRUCTURE

1. Share Capital History of our Company:

- a. Equity Share Capital

Our Company has made allotments of Equity Shares from time to time. The following is the Equity Share Capital Build-up of our Company:

Date of Allotment of Equity Shares	No. of Equity Shares	Face Value (₹)	Issue / Transfer Price (₹)	Nature / Reason of Allotment	Nature of Consideration	Cumulative No. of Equity Shares	Cumulative Paid Up Share Capital (₹)	Cumulative Share Premium (₹)
Upon Incorporation	10,000	10	10	Subscription to MoA	Cash	10,000	1.00	Nil
August 25, 2011	4,90,000	10	20.83	Further Allotment	Cash	5,00,000	50.00	53.01
March 27, 2015 ⁽¹⁾	15,00,000	10	10	Right Issue	Cash	20,00,000	200.00	53.01
November, 07 2017 ⁽²⁾	6,00,000	10	26	Right Issue	Cash	26,00,000	260.00	149.01
March 20, 2018 ⁽³⁾	13,00,000	10	Nil	Bonus Issue	Other than Cash	39,00,000	390.00	19.01

⁽¹⁾ Our Company has issued 15,00,000 Right Shares in the ratio of 3:1 i.e. 3 Shares for every 1 Equity Share held.



- (2) Our Company has issued 6,00,000 Right Shares in the ratio of 3:10 i.e. 3 Shares for every 10 Equity Shares held.
- (3) Our Company has issued 13,00,000 Bonus Shares in the ratio of 1:2 i.e. 1 Share for every 2 Equity Shares held, by way of capitalization of Securities Premium Account.
- b. Our Company has not issued any Equity Shares for consideration other than cash except as mentioned under Note 1 (a) of the chapter titled “Capital Structure” beginning on page no. 61 of this Prospectus;
- c. No shares have been allotted in terms of any scheme approved under sections 391-394 of the Companies Act, 1956;
- d. No bonus shares have been issued out of Re-valuation Reserves.
- e. No shares have been issued at a price lower than the Issue Price within the last one year from the date of the Prospectus except as mentioned under:

Date of Allotment	Name of the Allottees	Number of Shares	Category of Allottees	Face Value (₹)	Issue Price (₹)	Reasons
November 07, 2017	Mrs. Fatema S Kachwala	6,00,000	Promoter	10	26	Right Issue
March 20, 2018	Mr. Sanjay J Patel	2,08,625	Promoter	10	Nil	Bonus Issue
March 20, 2018	Mrs. Smita S Patel	1,48,125	Promoter	10	Nil	Bonus Issue
March 20, 2018	Mrs. Taruna P Patel	1,73,125	Promoter	10	Nil	Bonus Issue
March 20, 2018	Mr. Piyush J Patel	1,85,625	Promoter Group	10	Nil	Bonus Issue
March 20, 2018	Mr. Rushil S Patel	25,000	Promoter Group	10	Nil	Bonus Issue
March 20, 2018	Mrs. Priyanka M Geelani	25,000	Promoter Group	10	Nil	Bonus Issue
March 20, 2018	Mrs. Fatema S Kachwala	5,34,500	Promoter	10	Nil	Bonus Issue

f. Shareholding of our Promoters:

Set forth below are the details of the build-up of shareholding of our Promoters:

Date of Allotment / Transfer	Nature of Transaction	Consideration	No. of Shares	Face Value (₹)	Issue/Transfer Price (₹)	Cumulative no. of Shares	% of Pre-Issue Paid Up Capital	% of Post-Issue Paid Up Capital	Lock – in Period
Mr. Sanjay J Patel									
October 07, 2010	Transfer	Cash	1,225	10	10	1,225	0.03	0.02	3 Years
May 31, 2011 ⁽¹⁾	Transfer	Cash	3,400	10	10	6,325	0.13	0.10	-
			1,700 ⁽³⁾						3 Years
August 25, 2011 ⁽²⁾	Further Allotment	Cash	83,300 ⁽³⁾	10	20.82	86,225	2.14	1.66	3 Years
August 25, 2011	Further Allotment	Cash	60,025	10	20.82	61,250	1.54	1.20	3 Years
March 30, 2012	Transfer	Cash	(3,400)	10	10	1,46,250	(0.09)	(0.07)	-
March 27, 2015	Right Issue	Cash	2,71,000	10	10	6,36,250	12.56	9.76	3 Years
			2,19,000						-
May 12, 2017	Transfer	Cash	(50,000)	10	26	5,86,250	(1.28)	(1.00)	-
March 05, 2018	Transfer	Cash	(1,69,000)	10	28.60	4,17,250	(4.33)	(3.36)	-



Date of Allotment / Transfer	Nature of Transaction	Consideration	No. of Shares	Face Value (₹)	Issue/Transfer Price (₹)	Cumulative no. of Shares	% of Pre-Issue Paid Up Capital	% of Post-Issue Paid Up Capital	Lock – in Period
March 20, 2018	Bonus Issue	Other than Cash	22,800	10	Nil	6,25,875	5.35	4.15	3 Years
			1,85,825						1 Year

- (1) 1,700 shares each jointly held with Mr. Namdev Koli, Mrs. Naramada Bhagat and Mr. Balchandra Mhatre. Mr. Namdev Koli, Mrs. Naramada Bhagat and Mr. Balchandra Mhatre being the first holders.
- (2) Allotted jointly with Mr. Balchandra Mhatre. Mr. Sanjay Patel being the first holder.
- (3) Transferred to Mr. Sanjay Patel on December 05, 2014.
- (4) 4,40,050 Equity Shares of Mr. Sanjay J Patel will be locked-in for a period of three years and remaining for a period of one year.

Date of Allotment / Transfer	Nature of Transaction	Consideration	No. of Shares	Face Value (₹)	Issue Price (₹)	Cumulative no. of Shares	% of Pre-Issue Paid Up Capital	% of Post-Issue Paid Up Capital	Lock – in Period
Mrs. Smita S Patel									
October 07, 2010	Transfer	Cash	1,225	10	10	1,225	0.03	0.02	3 Years
August 25, 2011	Further Allotment	Cash	60,025	10	20.82	61,250	1.54	1.20	3 Years
August 25, 2011 ⁽¹⁾	Further Allotment	Cash	83,300 ⁽²⁾	10	20.82	1,44,550	2.14	1.66	3 Years
March 30, 2012	Transfer	Cash	1,700 ⁽²⁾	10	10	1,46,250	0.04	0.03	3 Years
March 27, 2015	Right Issue	Cash	1,11,000	10	10	3,46,250	5.13	3.98	3 Years
			39,000						1 Year
			50,000						-
May 12, 2017	Transfer	Cash	(50,000)	10	26	2,96,250	(1.28)	(1.00)	-
March 20, 2018	Bonus Issue	Other than Cash	1,48,125	10	Nil	4,44,375	3.80	2.95	1 Year

- (1) Allotted jointly with Mr. Namdev Koli. Mrs. Smita Patel being the first holder.
- (2) Transferred to Mrs. Smita Patel on December 05, 2014.
- (3) 2,57,250 Equity Shares of Mrs. Smita S Patel will be locked-in for a period of three years and remaining for a period of one year.

Date of Allotment / Transfer	Nature of Transaction	Consideration	No. of Shares	Face Value (₹)	Issue Price (₹)	Cumulative no. of Shares	% of Pre-Issue Paid Up Capital	% of Post-Issue Paid Up Capital	Lock – in Period
Mrs. Taruna P Patel									
October 07, 2010	Transfer	Cash	1,225	10	10	1,225	0.03	0.02	3 Years
August 25, 2011	Further Allotment	Cash	60,025	10	20.82	61,250	1.54	1.20	3 Years
August 25, 2011 ⁽¹⁾	Further Allotment	Cash	83,300 ⁽²⁾	10	20.82	1,44,550	2.14	1.66	3 Years
March 30, 2012	Transfer	Cash	1,700 ⁽²⁾	10	10	1,46,250	0.04	0.03	3 Years
March 27, 2015	Right Issue	Cash	1,76,000	10	10	4,46,250	7.69	5.97	3 Years



Date of Allotment / Transfer	Nature of Transaction	Consideration	No. of Shares	Face Value (₹)	Issue Price (₹)	Cumulative no. of Shares	% of Pre-Issue Paid Up Capital	% of Post-Issue Paid Up Capital	Lock – in Period
2015			24,000						1 Year
			1,00,000						-
May 12, 2017	Transfer	Cash	(100,000)	10	26	3,46,250	(2.56)	(1.99)	-
March 20, 2018	Bonus Issue	Other than Cash	1,73,125	10	Nil	5,19,375	4.44	3.45	1 Year

- (1) Allotted jointly with Mrs. Narmada Bhagat. Mrs. Taruna Patel being the first holder.
- (2) Transferred to Mrs. Taruna Patel on December 05, 2014.
- (3) 3,22,250 Equity Shares of Mrs. Taruna P Patel will be locked-in for a period of three years and remaining for a period of one year.

Date of Allotment / Transfer	Nature of Transaction	Consideration	No. of Shares	Face Value (₹)	Issue Price (₹)	Cumulative no. of Shares	% of Pre-Issue Paid Up Capital	% of Post-Issue Paid Up Capital	Lock – in Period
Mrs. Fatema S Kachwala									
May 12, 2017	Transfer	Cash	3,00,000	10	26	3,00,000	7.69	5.97	1 Year
November 07, 2017	Right Issue	Cash	6,00,000	10	26	9,00,000	15.38	11.95	1 Year
March 05, 2018	Transfer	Cash	1,69,000	10	28.60	10,69,000	4.33	3.36	1 Year
March 20, 2018	Bonus Issue	Other than Cash	5,34,500	10	Nil	16,03,500	13.71	10.64	1 Year

- (1) 16,03,500 Equity Shares of Mrs. Fatema S Kachwala will be locked-in for a period of one year.

Notes:

- None of the Shares belonging to our Promoters are pledged as on the dates of this Prospectus.
 - The entire post Issue Promoters' shares shall be subject to lock-in from the date of allotment of the equity shares issued through this Prospectus for periods as per applicable Regulations of the SEBI (ICDR) Regulations. For details please see "Notes to the Capital Structure" on page no. 61 of this Prospectus.
 - Our Promoters have confirmed to the Company and the Lead Manager that the Equity Shares held by our Promoters have been financed from their personal funds and no loans or financial assistance from any bank or financial institution has been availed for this purpose.
 - All the shares held by our Promoters, were fully paid-up on the respective dates of acquisition of such shares.
- g. Except as disclosed below, none of the members of the Promoters, Promoters Group, Directors and their immediate relatives have purchased or sold any Equity shares of our Company within the last six months from the date of the Draft Prospectus:

Date of Transfer	Name of Transferor	Name of Transferee	No. of Shares (F.V. ₹ 10)	Price (₹)	Nature of Transaction	Nature of Consideration
December 04,	Mr. Piyush J	Mr. Rushil P	50,000	26	Transfer	Cash



Date of Transfer	Name of Transferor	Name of Transferee	No. of Shares (F.V. ₹ 10)	Price (₹)	Nature of Transaction	Nature of Consideration
2017	Patel	Patel				
December 04, 2017	Mr. Piyush J Patel	Mrs. Priyanka M Geelani	50,000	26	Transfer	Cash
March 05, 2018	Mr. Sanjay J Patel	Mrs. Fatema S Kachwala	1,69,000	28.60	Transfer	Cash

h. None of the members of the Promoter Group, Directors and their immediate relatives have financed the purchase by any other person of Equity shares of our Company other than in the normal course of business of the financing entity within the period of six months immediately preceding the date of the Draft Prospectus.

2. Promoters' Contribution and other Lock-In details:

a. Details of Promoters' Contribution locked-in for 3 years

Pursuant to the Regulation 32(1) and 36(a) of the SEBI (ICDR) Regulations, an aggregate of 20% of the Post-Issue Equity Share Capital held by our Promoter shall be considered as promoters' contribution ("**Promoters' Contribution**") and locked-in for a period of three years from the date of Allotment. The lock-in of the Promoters' Contribution would be created as per applicable law and procedure and details of the same shall also be provided to the Stock Exchange before listing of the Equity Shares.

The details of the Promoter's Equity Shares proposed to be locked-in for a period of three years are as follows:

Name of Promoters	No. of Shares locked in ⁽¹⁾	As a % of Post Issue Share Capital
Mr. Sanjay J Patel	4,40,050	8.76%
Mrs. Smita S Patel	2,57,250	5.12%
Mrs. Taruna P Patel	3,22,250	6.42%
Total	10,19,550	20.30%

⁽¹⁾ For details on the date of Allotment of the above Equity Shares, the nature of Allotment, face value and the price at which they were acquired, please see "Notes to Capital Structure" on page no. 61 of this Prospectus.

We confirm that in compliance with regulation 33 of SEBI ICDR Regulations, the minimum Promoter contribution of 20% as shown above which is subject to lock-in for three years does not consist of:

- Equity Shares acquired during the preceding three years for consideration other than cash and out of revaluation of assets or capitalization of intangible assets or bonus shares out of revaluation reserves or reserves without accrual of cash resources or from bonus issue against equity shares which are ineligible for minimum promoters' contribution.
- Equity Shares acquired by the Promoter during the preceding one year, at a price lower than the price at which Equity Shares are being Issued to public in the Issue, except the bonus shares issued.
- Private placement made by solicitation of subscription from unrelated persons either directly or through any intermediary.
- The Equity Shares held by the Promoter and Issued for minimum 20% Promoters' Contribution are not subject to any pledge.
- Equity Shares for which specific written consent has not been obtained from the shareholders for inclusion of their subscription in the minimum Promoters' Contribution subject to lock-in.
- Equity shares issued to our Promoters on conversion of Partnership Firms into Limited Companies.



The minimum Promoters' Contribution has been brought to the extent of not less than the specified minimum lot and from the persons defined as Promoters under the SEBI (ICDR) Regulations, 2009. The Promoters' Contribution constituting 20.30% of the post-Issue capital shall be locked-in for a period of three years from the date of Allotment of the Equity Shares in the Issue.

We further confirm that our Promoters' Contribution of 20% of the Post Issue Equity does not include any contribution from Alternative Investment Funds.

b. Details of Shares locked-in for one year

- a. Pursuant to Regulation 37 of the SEBI (ICDR) Regulations, in addition to the Promoters' Contribution to be locked-in for a period of 3 years, as specified above, the entire Pre-Issue Equity Share capital will be locked in for a period of one (1) year from the date of Allotment in this Issue, other than the Equity Shares allotted and subscribed pursuant to the Offer for Sale.
- b. Pursuant to Regulation 39 of the SEBI Regulations, the Equity Shares held by our Promoter can be pledged only with banks or financial institutions as collateral security for loans granted by such banks or financial institutions for the purpose of financing one or more of the objects of the Issue and the pledge of shares is one of the terms of sanction of such loan. However, as on date of this Prospectus, none of the Equity Shares held by our Promoters have been pledged to any person, including banks and financial institutions.
- c. Pursuant to Regulation 40 of the SEBI (ICDR) Regulations, Equity Shares held by our Promoter, which are locked in as per Regulation 36 of the SEBI (ICDR) Regulations, may be transferred to and amongst our Promoter/ Promoter Group or to a new promoter or persons in control of our Company subject to continuation of the lock-in in the hands of the transferees for the remaining period and compliance with Securities and Exchange Board of India (Substantial Acquisition of Shares and Takeover) Regulations, 2011 as applicable.
- d. Pursuant to Regulation 40 of the SEBI (ICDR) Regulations, Equity Shares held by shareholders other than our Promoter, which are locked-in as per Regulation 37 of the SEBI (ICDR) Regulations, may be transferred to any other person holding shares, subject to continuation of the lock-in in the hands of the transferees for the remaining period and compliance with Securities and Exchange Board of India (Substantial Acquisition of Shares and Takeover) Regulations, 2011 as applicable.

3. Pre-Issue and Post-Issue Shareholding of our Promoter and Promoter' Group

Set forth is the shareholding of our Promoter and Promoter Group before and after the proposed Issue:

Category of Promoters	Pre Issue		Post Issue	
	No. of Shares	%	No. of Shares	%
Promoter				
Mr. Sanjay J Patel	6,25,875	16.05%	6,25,875	12.46%
Mrs. Smita S Patel	4,44,375	11.39%	4,44,375	8.85%
Mrs. Taruna P Patel	5,19,375	13.32%	5,19,375	10.34%
Mrs. Fatema S Kachwala	16,03,500	41.12%	16,03,500	31.92%
Promoter Group				
Mr. Piyush J Patel	5,56,875	14.28%	3,11,875	6.21%
Mr. Rushil P Patel	75,000	1.92%	75,000	1.49%
Mrs. Priyanka M Geelani	75,000	1.92%	75,000	1.49%
Total Promoter & Promoter Group Holding	39,00,000	100.00%	36,55,000	72.77%
Total Paid up Capital	39,00,000	100.00%	50,23,000	100.00%



4. Details of Offer for Sale

The following are the details of the Equity Shares being offered as part of the Offer for Sale:

Sr. No.	Name of Selling Shareholders	Total Number of Equity Shares currently held ⁽¹⁾	Number of Equity Shares offered for the Offer for Sale
1.	Piyush J Patel	5,56,875	2,45,000

⁽¹⁾ For details regarding the build up of the shares being offered in Offer for sale please see “Notes to Capital Structure” on page no. 61 of this Prospectus.

Set forth below are the details of the build-up of Equity Shares of the Selling Shareholder, Mr. Piyush J Patel:

Date of Allotment / Transfer	Nature of Transaction	Consideration	No. of Shares	Face Value (₹)	Issue Price (₹)	Cumulative no. of Shares
October 07, 2010	Transfer	Cash	1,225	10	10	1,225
August 25, 2011	Further Allotment	Cash	60,025	10	20.82	61,250
March 27, 2015	Right Issue	Cash	5,10,000	10	10	5,71,250
May 12, 2017	Transfer	Cash	(1,00,000)	10	26	4,71,250
March 20, 2018	Bonus Issue	Other than Cash	1,85,625	10	Nil	5,56,875

5. The top ten shareholders of our Company and their Shareholding is as set forth below:

a. The top ten Shareholders of our Company as on the date of this Prospectus are:

Sr. No.	Particulars	No. of Shares	% of Pre-Issue Share Capital
1.	Mrs. Fatema S Kachwala	16,03,500	41.12%
2.	Mr. Sanjay J Patel	6,25,875	16.05%
3.	Mrs. Smita S Patel	4,44,375	11.39%
4.	Mrs. Taruna P Patel	5,19,375	13.32%
5.	Mr. Piyush J Patel	5,56,875	14.28%
6.	Mr. Rushil S Patel	75,000	1.92%
7.	Mrs. Priyanka M Geelani	75,000	1.92%
Total		39,00,000	100.00%

b. The top ten Shareholders of our Company ten days prior to date of this Prospectus are:

Sr. No.	Particulars	No. of Shares	% of Pre-Issue Share Capital
1.	Mrs. Fatema S Kachwala	16,03,500	41.12%
2.	Mr. Sanjay J Patel	6,25,875	16.05%
3.	Mrs. Smita S Patel	4,44,375	11.39%
4.	Mrs. Taruna P Patel	5,19,375	13.32%
5.	Mr. Piyush J Patel	5,56,875	14.28%
6.	Mr. Rushil S Patel	75,000	1.92%
7.	Mrs. Priyanka M Geelani	75,000	1.92%
Total		39,00,000	100.00%

c. The top ten Shareholders of our Company two years prior to date of this Prospectus are:



Sr. No.	Particulars	No. of Shares	% of Shares then Share Capital
1.	Mr. Sanjay J Patel	6,36,250	31.81%
2.	Mrs. Smita S Patel	3,46,250	17.31%
3.	Mrs. Taruna P Patel	4,46,250	22.31%
4.	Mr. Piyush J Patel	5,71,250	28.56%
Total		20,00,000	100.00%

6. Neither the Company, nor its Promoter, Directors or the Lead Manager have entered into any buyback and/or standby arrangements for purchase of Equity Shares of the Company from any person.
7. None of our Directors or Key Managerial Personnel holds Equity Shares in the Company, except as stated in the chapter titled “*Our Management*” beginning on page no. 128 of this Prospectus.
8. Investors may note that in case of over-subscription, in all the categories, the allocation in the Issue shall be as per the requirement of Regulation 43(4) of SEBI (ICDR) Regulations, as amended from time to time. The allotment will be on proportionate basis as detailed under “*Basis of Allotment*” in the chapter titled “*Issue Procedure*” beginning on page no. 225 of this Prospectus.
9. An investor cannot make an application for more than the number of Equity Shares Issued in this Issue, subject to the maximum limit of investment prescribed under relevant laws applicable to each category of investor.
10. An over-subscription to the extent of 10% of the Fresh Issue can be retained for the purpose of rounding off to the nearest integer during finalizing the allotment, subject to minimum allotment, which is the minimum application size in this Issue. Consequently, the actual allotment may go up by a maximum of 10% of the Issue, as a result of which, the post-Issue paid up capital after the Issue would also increase by the excess amount of allotment so made. In such an event, the Equity Shares held by the Promoter and subject to lock-in shall be suitably increased; so as to ensure that 20% of the post Issue paid-up capital is locked in.
11. Under subscription, if any, in any of the categories, would be allowed to be met with spill-over from any of the other categories or a combination of categories at the discretion of our Company in consultation with the Lead Manager and Designated Stock Exchange. Such inter-se spill over, if any, would be effected in accordance with applicable laws, rules, regulations and guidelines. The allocation in the Issue shall be as per the requirements of Regulation 43(3) of SEBI (ICDR) Regulations, as amended from time to time.
12. No payment, direct, indirect in the nature of discount, commission, and allowance, or otherwise shall be made either by us or by our Promoter to the persons who receive allotments, if any, in this Issue.
13. As on date of this Prospectus, there are no outstanding financial instruments or any other rights that would entitle the existing Promoter or shareholders or any other person any option to receive Equity Shares after the Issue.
14. There shall be only one denomination of Equity Shares of our Company unless otherwise permitted by law. Our Company shall comply with disclosure and accounting norms as may be specified by SEBI from time to time.
15. Since the entire application money is being called on application, all successful applications, shall be issued fully paid up shares only. Also, as on the date of this Prospectus the entire pre-Issue share capital of the Company has been made fully paid up.
16. Except as disclosed in this Prospectus, our Company presently does not have any intention or proposal to alter its capital structure for a period of six months commencing from the date of opening of this Issue, by way of split / consolidation of the denomination of Equity Shares or further issue of Equity Shares or securities



convertible into Equity Shares, whether on a preferential basis or issue of bonuses or rights or further public issue of specified securities or Qualified Institutional Placement.

17. We have not issued any Equity Shares out of revaluation reserves. We have not issued any Equity Shares for consideration other than cash except as stated in this Prospectus.
18. As on date of this Prospectus, there are no outstanding ESOP's, warrants, options or rights to convert debentures, loans or other instruments convertible into the Equity Shares, nor has the company ever allotted any equity shares pursuant to conversion of ESOP's till date.
19. Our Company shall ensure that transactions in the Equity Shares by our Promoter and our Promoter Group between the date of the Prospectus and the Issue Closing Date shall be reported to the Stock Exchange within 24 hours of such transaction.
20. The Lead Manager and its associates do not directly or indirectly hold any shares of the Company.
21. Our Company has Seven (7) shareholders, as on the date of this Prospectus.
22. Our Company has not re-valued its assets since incorporation.
23. None of the public Shareholders hold more than 1% of the pre-offer paid-up capital of our Company.
24. Shareholding Pattern of the Company:



The following is the shareholding pattern of the Company as on the date of this Prospectus

Category (I)	Category of Share-holder (II)	No. of Share-holder (III)	No. of fully paid-up equity shares held (IV)	No. of Partly paid-up equity shares held (V)	No. of shares Underlying Depository Receipts (VI)	Total Nos. Shares held (VII) = (IV) + (V) + (VI)	Share holding as a % of total No. of Shares (calculated As per SCRR, 1957)(VIII)As a % of (A+B+C2)	Number of Voting Rights held in each Class of securities (IX)				No of Underlying Outstanding Convertible securities (incl. Warrants) (X)	Share Holding as a % assuming Full convertible securities (as a % of Diluted Share Capital)(XI)=(VII)+(X) As a % of (A+B+C2)	Number of Locked In shares (XII)		No. of shares Pledged Or Otherwise encumbered (XIII)		No. of Equity shares held in De-mat form (XIV)
								No of voting Right			Total As a % of (A+B+C)			No (a)	As a % of total shares held (b)	No (a)	As a % of total shares held (b)	
								Class-Equity	Classes	Total								
(A)	Promoter & Promoter Group	7	39,00,000	-	-	39,00,000	100%	39,00,000	-	39,00,000	100%	-	100%	-	-	-	-	39,00,000
(B)	Public	-	-	-	-	-	-	-	-	-	-	-	-	-	-	-	-	-
(C)	Non Promoter Non Public	-	-	-	-	-	-	-	-	-	-	-	-	-	-	-	-	-
(C1)	Shares Underlying DRs	-	-	-	-	-	-	-	-	-	-	-	-	-	-	-	-	-
(C2)	Shares held by Employee Trusts	-	-	-	-	-	-	-	-	-	-	-	-	-	-	-	-	-
	Total	7	39,00,000	-	-	39,00,000	100%	39,00,000	-	39,00,000	100%	-	100%	-	-	-	-	39,00,000



SECTION IV – PARTICULARS OF THE ISSUE

OBJECTS OF THE ISSUE

The Issue comprises a Fresh Issue by our Company and an Offer for Sale by the Selling Shareholder.

The Offer for Sale

Our Company will not receive any proceeds of the Offer for Sale by the Selling Shareholder.

The Fresh Issue

The objectives of the Fresh Issue are to raise funds for:

- Funding Long Term Working Capital Requirements and
- Funding Expenditure for General Corporate Purposes

Also, the listing of our Equity Shares on the SME Exchange, we believe, would provide liquidity to our shareholders, enhance our visibility and better our brand name.

The Main Objects clause as set out in the Memorandum of Association enables our Company to undertake its existing activities and the activities for which funds are being raised by the Company through the present Fresh Issue. Further, we confirm that the activities that we have been conducting until now are in accordance with the objects clause of our Memorandum of Association.

Fresh Issue Proceeds & Net Proceeds

The details of the proceeds of the Fresh Issue are set forth in the table below:

Particulars	Amount (₹ in lakhs)
Gross Proceeds from Fresh Issue	774.87
Less: Company's share of Issue related Expenses ⁽¹⁾⁽²⁾	42.00
Net Proceeds from Fresh Issue	732.87

⁽¹⁾ Except for the Listing fees and Market Making fees, which will be borne by our Company, all other expenses relating to the Issue as mentioned above will be borne by our Company and the Selling Shareholder in proportion to the Equity Shares contributed / issued in the Issue.

⁽²⁾ The Issue expenses are estimated expenses and subject to change.

Requirements of Funds and Means of Finance

The fund requirements described below are based on internal management estimates and have not been appraised by any bank, financial institution.

The net proceeds of the Fresh Issue are to be utilized as shown below:

Sr. No.	Particulars	Amount (₹ in lakhs)
1.	Funding Long Term Working Capital Requirement	730.00
2.	Expenditure for General Corporate Purposes	2.87
Total		732.87

The entire fund requirements are to be financed from the Net Fresh Issue Proceeds, and there is no requirement to make firm arrangements of finance under Regulation 4(2)(g) of the SEBI Regulations through verifiable means towards at least 75% of the stated means of finance, excluding the amounts to be raised through the Fresh Issue.



The fund requirement and deployment is based on internal management estimates and have not been appraised by any bank or financial institution. Our management, in response to the competitive and dynamic nature of the industry, will have the discretion to revise its business plan from time to time and consequently our funding requirement and deployment of funds may also change. This may, subject to compliance with applicable laws and regulations, also include rescheduling the proposed utilization of Fresh Issue Proceeds and increasing or decreasing expenditure for a particular object *vis-à-vis* the utilization of Fresh Issue Proceeds.

In case of variations in the actual utilization of funds earmarked for the purposes set forth above, increased fund requirements for a particular purpose may be financed by surplus funds, if any, available in respect of the other purposes for which funds are being raised in this Issue. If surplus funds are unavailable or in case of cost overruns, we expect that the shortfall will be met from internal accruals and/or entering into funding arrangements as required. Any variation in the objects of the Fresh Issue shall be undertaken in accordance with the terms of the Companies Act and the rules framed there under.

In case of delays in raising funds from the Fresh Issue, our Company may deploy certain amounts towards any of the above mentioned Objects through a combination of Internal Accruals or Unsecured / Bridge Loans and in such case the Funds raised shall be utilized towards repayment of Unsecured Loans or recouping of Internal Accruals. However, we confirm that except as mentioned below no unsecured / bridge financing has been availed as on date for the above mentioned objects, which is subject to being repaid from the Net Fresh Issue Proceeds.

For further details on the risks involved in our proposed fund utilization as well as executing our business strategies, please see the section titled “*Risk Factors*” beginning on page no. 15 of this Prospectus.

DETAILS OF THE FUND REQUIREMENTS

1. Funding Long Term Working Capital Requirements:

Our Company manufactures and fabricates various steel products which are meant for its application in Pipe Support Systems, HVAC Systems, Anti-vibration System and Equipments for Industrial, Commercial, Utility and OEM Installations. We also manufacture various engineering products, metal and base metal products like G. I. nuts, various types of bolts, clamps, hangers etc. We have to provide credit period to our Customers in order to maintain steady flow of orders. Further, our business is mainly export oriented and hence this increases our inventory holding periods.

Further, our Company is also engaged into trading of textile products on a primarily B2B model wherein we provide goods on credit to our customers and hence this segment also requires working capital funds.

The working capital needs as estimated by our management are as explained below:

Basis of estimation of working capital requirement and estimated working capital requirement

(₹ in Lakhs)

Sr. No.	Particulars	Holding Days (Rounded-off)	For Fiscal 2017-18	Holding Days	For Fiscal 2018-19 (Estimated)
A	Current Assets:				
1	Inventories	56	698.45	56	699.89
2	Sundry Debtors	130	2,104.51	130	2,221.57
3	Short Term loans and advances (Including Cash)	-	434.83	-	400.00
	Total Current Assets (A)		3,237.77		3,321.46
B	Current Liabilities				
1	Sundry Creditors	74	918.08	60	749.88
2	Other Current Liabilities and Provisions	-	245.26	-	200.00



Sr. No.	Particulars	Holding Days (Rounded-off)	For Fiscal 2017-18	Holding Days	For Fiscal 2018-19 (Estimated)
	Total Current Liabilities (B)		1,163.34		949.88
C	Total Working Capital Gap (A – B)		2,074.43		2,371.58
D	Funding Pattern:				
1	Cash Credit from Bank		1,288.38		891.58
2	Internal Accruals / Owned Funds		786.05		750.00
3	Part of the Net proceeds to be utilised		-		730.00

Hence, our Company proposes to utilise ₹ 730.00 lakhs of the Net Proceeds towards working capital requirements for meeting our future business requirements.

Justification for holding period levels

Particulars	Details
Current Assets	
Inventories	Inventories days are computed as a function of purchases from the historic Restated Financial Statements and are adjusted for future expected. Our Company has a varied product portfolio and a wide scope including jobbing, machining, manufacturing and fabrication of various engineering goods, steel products, nuts, bolts etc. The inventory holding period for the Financial Year 2017-18 was approx. 56 days. The inventory holding period has been estimated to be in the same line of 56 days for the Financial Year 2018-19.
Trade Receivables	Trade Receivables days are computed as a function of Sales from the historic Restated Financial Statements and are adjusted for future estimates. Our Company operates in a highly competitive environment, including the organized and unorganized sector. Further, acquiring and retaining large customers requires us to provide them sufficient credit period, which sometimes may be a little higher than general industry standards. The credit period for the Financial Year 2017-18 was around 130 days. The credit period for trade receivable has been estimated, to be in the same line of FY 2017-18, i.e of 130 days for the Financial Year 2018-19.
Current Liabilities	
Trade Payables	Trade Payable days are computed as a function of purchases from the historic Restated Financial Statements and are adjusted for future estimates. Creditors include creditor for goods and expenses. To avail timely raw materials and high quality goods from our suppliers we do not keep a large credit period as compare to trade receivable. For the Financial Year 2017-18, a trade payables days was approx. 74 days whereas we have estimated trade payables days of around 60 days for the Financial Year 2018-19.

2. Expenditure for General Corporate Purpose:

We propose to deploy ₹ 2.87 lakhs aggregating to 0.39 % of the Proceeds of the Fresh Issue towards General Corporate Purposes, including but not restricted to strategic initiatives, partnerships, joint ventures and acquisitions, meeting exigencies which our Company may face in the ordinary course of business, to renovate and refurbish certain of our existing Company owned/leased and operated facilities or premises or towards repayment/ pre-payment of liabilities or towards brand promotion activities or any other purposes as may be approved by our Board.

We confirm that any Fresh issue related expenses shall not be considered as a part of General Corporate Purpose. Further, we confirm that the amount for general corporate purposes, as mentioned in this Prospectus, shall not exceed 25% of the amount raised by our Company through this Issue.



ISSUE RELATED EXPENSES

The total estimated Issue Expenses are ₹ 50.25 lakhs, which is 5.32% of the total Issue Size. The details of the Issue Expenses are tabulated below:

Sr. No.	Particulars	Amount (₹ in lakhs)	% of Total Expenses	% of Total Issue size
1.	Issue Management fees including fees and reimbursements of Market Making fees (1 st year), and payment to other intermediaries such as Legal Advisors, Registrars and other out of pocket expenses.	39.00	77.61%	4.13%
2.	Brokerage and Selling Commission, Underwriting Commission, RTAs and CDPs ⁽¹⁾⁽²⁾⁽³⁾⁽⁴⁾	1.25	2.49%	0.13%
3.	Advertisement, Printing & Stationery, Marketing Expenses, etc.	4.00	7.96%	0.42%
4.	Listing Fees, Market Regulatory & Other Expenses	6.00	11.94%	0.64%
Total		50.25	100.00%	5.32%

1. Except for the Listing Fees & the Market Making Fees, which will be borne by our Company, all other expenses relating to the Issue as mentioned above will be borne by the Company and Selling Shareholders in proportion to the Equity Shares contributed to the Issue. The Issue expenses are estimated expenses and subject to change.
2. The SCSBs and other intermediaries will be entitled to a commission of ₹ 10 per every valid Application Form submitted to them and uploaded on the electronic system of the Stock Exchange by them.
3. The SCSBs would be entitled to processing fees of ₹ 10 per Application Form, for processing the Application Forms procured by other intermediaries and submitted to the SCSBs.
4. Further the SCSBs and other intermediaries will be entitled to selling commission of 0.01 % of the Amount Allotted (product of the number of Equity Shares Allotted and the Issue Price) for the forms directly procured by them and uploaded on the electronic system of the Stock Exchange by them.

Schedule of Implementation

All of the above objects are proposed to be utilised in the Financial Year 2018-19.

Year wise Deployment of Funds / Schedule of Implementation

As on the date of this Prospectus, no funds have been deployed on these objects. The entire Issue size is proposed to be deployed in the Financial Year 2018 - 19.

Appraisal and Bridge Loans

The objects have not been appraised by any banks, financial institutions or agency. Also, our Company has not entered into any bridge finance arrangements that will be repaid from the Net Proceeds of the Fresh Issue. However, our Company may draw down such amounts, as may be required, from an overdraft arrangement or short term advances in form of director loans or ICDs, to finance any of the above mentioned objects until the completion of the Issue.

Any amount that is drawn down from such bridge financing during this period to finance above mentioned objects will be repaid from the Net Proceeds of the Fresh Issue.

Interim Use of Funds

Pending utilization of the Net Fresh Issue Proceeds for the purposes described above, our Company will deposit the Net Fresh Issue Proceeds with scheduled commercial banks included in schedule II of the RBI Act. Our Company confirms that it shall not use the Net Fresh Issue Proceeds for buying, trading or otherwise dealing in shares of any listed company or for any investment in the equity markets.



Monitoring of Utilization of Funds

There is no requirement for a monitoring agency as the Fresh Issue size is less than ₹ 10,000 lakhs. Pursuant to Regulation 32(3) of the SEBI (LODR) Regulations, 2015, our Company shall on a half yearly basis disclose to the Audit Committee the uses and application of the Net Proceeds. Until such time as any part of the Net Proceeds remains unutilized, our Company will disclose the utilization of the Net Proceeds under separate heads in our Company's balance sheet(s) clearly specifying the amount of and purpose for which Net Proceeds have been utilized so far, and details of amounts out of the Net Proceeds that have not been utilized so far, also indicating interim investments, if any, of such unutilized Net Proceeds. In the event that our Company is unable to utilize the entire amount that we have currently estimated for use out of the Net Proceeds in a fiscal, we will utilize such unutilized amount in the next fiscal.

Further, in accordance with Regulation 32(1)(a) of the SEBI (LODR) Regulations, 2015, our Company shall furnish to the Stock Exchanges on a half yearly basis, a statement indicating material deviations, if any, in the utilization of the Net Proceeds for the objects stated in this Prospectus.

Variation in Objects

In accordance with Section 27 of the Companies Act, 2013, our Company shall not vary the Objects of the Issue without our Company being authorised to do so by the Shareholders by way of a special resolution. In addition, the notice issued to the Shareholders in relation to the passing of such special resolution shall specify the prescribed details as required under the Companies Act. The notice in respect of such resolution to Shareholders shall simultaneously be published in the newspapers, one in English and one in Regional language of the jurisdiction where our Registered Office is situated. The Shareholders who do not agree to the above stated proposal, our Promoter or controlling Shareholders will be required to provide an exit opportunity to such dissenting Shareholders, at a price as may be prescribed by SEBI, in this regard.

Other Confirmations

No part of the Net Proceeds of the Fresh Issue will be paid by our Company as consideration to our Promoters, our board of Directors, our Key Management Personnel or Group Company except in the normal course of business and in compliance with applicable law.



BASIC TERMS OF THE ISSUE

Terms of the Issue

The Equity Shares being Issued are subject to the provisions of the Companies Act, our Memorandum and Articles of Association, the terms of the Offer Document, Application Form, the Confirmation of Allocation Note and other terms and conditions as may be incorporated in the allotment advices and other documents/certificates that may be executed in respect of the Issue. The Equity Shares shall also be subject to laws as applicable, guidelines, notifications and regulations relating to the Issue of capital and listing and trading of securities issued from time to time by SEBI, the Government of India, the Stock Exchanges, the RBI, RoC and/or other authorities, as in force on the date of the Issue and to the extent applicable.

Authority for the Issue

The present Issue has been authorized pursuant to a resolution of our Board dated March 20, 2018 and by Special Resolution passed under Section 62(1)(c) of the Companies Act, 2013 at an Extra-Ordinary General Meeting of our shareholders held with a shorter notice on March 22, 2018.

The Offer for Sale has been authorised by Mr. Piyush J Patel (“Selling Shareholder”) by his consent letter dated March 19, 2018 to offer 2,45,000 Equity Shares.

The Selling Shareholder have confirmed that the Equity Shares proposed to be offered and sold in the Issue are eligible in term of SEBI (ICDR) Regulations and that he is not prohibited from dealings in securities market and the Equity Shares offered and sold are free from any lien, encumbrance or third party rights. The Selling Shareholder has also confirmed that he is the legal and beneficial owners of the Equity Shares being offered by him under the Offer for Sale.

Other Details

Face Value	The Equity Shares to be Issued pursuant to this Issue, having a face value of ₹ 10 each are being Issued in terms of this Prospectus. Subject to applicable laws, there shall be, at any given point of time, only one denomination of the Equity Shares of our Company.
Issue Price per Share	The Equity Shares pursuant to this Prospectus are being issued at a price of ₹ 69/- each.
Terms of Payment	Applications should be for a minimum of 2,000 equity shares and 2,000 equity shares thereafter. The entire Issue Price of the equity shares of ₹ 69/- per share is payable on application. In case of allotment of lesser number of equity shares than the number applied, the excess amount paid on application shall be refunded / unblocked to the applicants.
Ranking of the Equity Shares	The Equity Shares Issued pursuant to this Issue shall be subject to the Memorandum and Articles of Association of the Company and shall rank <i>pari-passu</i> in all respects including dividends with the existing Equity Shares of the Company. The allottees will be entitled to dividend, voting rights or any other corporate benefits, if any, declared by us after the date of Allotment.
Market Lot and Trading Lot	The Market lot and Trading lot for the Equity Share is 2,000 and in multiples of 2,000 thereafter; subject to a minimum allotment of 2,000 Equity Shares to the successful applicants.

Minimum Subscription

The requirement for 90% minimum subscription in terms of Regulation 14 of the ICDR Regulations is not applicable to the Issue. In terms of Regulation 106P(1) of the ICDR Regulations, the Issue is not restricted to any minimum subscription level and is 100% underwritten. Further, pursuant to Regulation 106R of the ICDR Regulations, our Company shall ensure that the number of prospective allottees to whom Equity Shares will be allotted shall not be less than 50.

If we do not receive the subscription of 100% of the Issue through this Issue document including devolvement of Underwriters within sixty days from the date of closure of the Issue, we shall forthwith refund the entire subscription



amount received. If there is a delay beyond eight days after we become liable to pay the amount, we shall pay interest prescribed under the applicable provisions of the Companies Act, 2013.



BASIS FOR ISSUE PRICE

The Issue Price has been determined by our Company in consultation with the Lead Manager on the basis of the key business strengths. The face value of the Equity Shares is ₹ 10/- and Issue Price is ₹ 69/- per Equity Shares and is 6.90 times of the face value. Investors should read the following basis with the sections titled “Risk Factors” and “Financial Information” and the chapter titled “Our Business” beginning on page nos. 15, 151 and 96 respectively, of this Prospectus to get a more informed view before making any investment decisions. The trading price of the Equity Shares of Our Company could decline due to these risk factors and you may lose all or part of your investments.

Qualitative Factors

We believe that the following strengths help differentiate us from our competitors and enable us to compete successfully in our industry:

- Well experienced Management;
- Compliance with Quality standards and consistency in quality and service;
- UL and FM Approved Product range meeting with International Standards;
- Customised Product Development;
- Strong Customer base;
- Scalable Business Model

For further details regarding some of the qualitative factors, which form the basis for computing the Issue Price, please see “Our Business - Our Strengths” on page no. 96 of this Prospectus.

Quantitative Factors

Information presented in this chapter is derived from restated financial statements prepared in accordance with Indian GAAP.

1) Earnings per Share (EPS)

Year ended March 31,	Basic & Diluted	
	EPS (in ₹) ⁽¹⁾	Weight
2018	2.96	3
2017	2.98	2
2016	2.40	1
Weighted Average		2.87

⁽¹⁾ Based on Restated Financials of our Company

Notes:

- a. Basic EPS has been calculated as per the following formula:

$$\text{Basic EPS (₹)} = \frac{\text{Net profit/ (loss) as restated, attributable to Equity Shareholders}}{\text{Weighted average number of Equity Shares outstanding during the year/period}}$$

- b. Diluted EPS has been calculated as per the following formula:

$$\text{Diluted EPS (₹)} = \frac{\text{Net profit/ (loss) as restated, attributable to Equity Shareholders}}{\text{Diluted Weighted average number of Equity Shares outstanding during the year/period}}$$

- c. Earnings per share calculations are in accordance with Accounting Standard 20 “Earnings per Share” prescribed by the Companies (Accounting Standard) Rules, 2006



2) **Price Earnings Ratio (P/E) in relation to the Issue price of ₹ 69/- per share of ₹ 10/- each.**

Particulars	Standalone
P/E ratio based on Basic and Diluted EPS as at March 31, 2018	23.33
P/E ratio based weighted average EPS	24.01

Industry P/E	
Highest – Suraj Limited	275.00
Lowest – Prakash Industries Limited	6.50
Industry Average	13.90

(Source: Capital Market, Vol. XXXIII/11, July 16-29, 2018; Segment: Steel - Medium/ Small)

3) **Return on Net Worth (RoNW)**

Year ended March 31	RoNW (%)	Weight
2018	14.63%	3
2017	19.24%	2
2016	19.20%	1
Weighted Average		16.93%

Note: Return on Net worth has been calculated as per the following formula:

$$\text{RoNW (\%)} = \frac{\text{Net profit/loss after tax, as restated}}{\text{Net worth excluding preference share capital and revaluation reserve}}$$

4) Minimum Return on Net Worth (RoNW) after Issue needed to maintain the Pre-Issue Basic & diluted EPS for the FY 2017-18 (based on Restated Financials) at the Issue Price of ₹ 69/- is 9.69%.

5) **Net Asset Value (NAV)**

Financial Year	Standalone
NAV as at March 31, 2018	18.78
NAV after Issue	30.53
Issue Price	69.00

Note:

Net Asset Value has been calculated as per the following formula:

$$\text{NAV} = \frac{\text{Net worth excluding preference share capital and revaluation reserve}}{\text{Outstanding number of Equity shares outstanding during the year/ period}}$$

6) **Comparison with Industry peers**

We believe that there is no other listed company which is specifically comparable to us w.r.t. our business model, size and financials.

7) The Company and the Promoter Group Selling Shareholder in consultation with the Lead Manager believes that the Issue price of ₹ 69/- per share for the Public Issue is justified in view of the above parameters. The investors may also want to peruse the Risk Factors and Financials of the company including important profitability and return ratios, as set out in the Financial Statements included in this Prospectus to have more informed view about the investment proposition. The Face Value of the Equity Shares is ₹ 10/- per share and the Issue Price is 6.90 times of the face value i.e. ₹ 69/- per share.



STATEMENT OF TAX BENEFITS

To,
The Board of Directors
Saketh Exim Limited
Plot No- PAP D- 146/ 147, TTC MIDC
Turbhe, Navi Mumbai - 400705

Dear Sirs,

Subject: Statement of Possible Special Tax Benefits available to Saketh Exim Limited and its shareholders prepared in accordance with the requirements under Schedule VIII – Clause (VII) (L) of the Securities and Exchange Board of India (Issue of Capital and Disclosure Requirements) Regulations, 2009 as amended (the ‘Regulations’)

We hereby report that the enclosed annexure prepared by Saketh Exim Limited, states the possible special tax benefits available to Saketh Exim Limited (‘the Company’) and the shareholders of the Company under the Income Tax Act, 1961 (‘Act’), presently in force in India. Several of these benefits are dependent on the Company or its shareholders fulfilling the conditions prescribed under the relevant provisions of the Act. Hence, the ability of the Company or its shareholders to derive the special tax benefits is dependent upon fulfilling such conditions, which based on the business imperatives, the company may or may not choose to fulfil.

The benefits discussed in the enclosed Annexure cover only special tax benefits available to the Company and do not cover any general tax benefits available to the Company. Further, the preparation of enclosed statement and the contents stated therein is the responsibility of the Company’s management. We are informed that, this Statement is only intended to provide general information to the investors and is neither designed nor intended to be a substitute for professional tax advice. In view of the individual nature of the tax consequences and the changing tax laws, each investor is advised to consult his or her own tax consultant with respect to the specific tax implications arising out of their participation in the proposed initial public issue of equity shares (“the Issue”) by the Company.

We do not express any opinion or provide any assurance as to whether:

- a) The Company or its Equity Shareholders will continue to obtain these benefits in future; or
- b) The conditions prescribed for availing the benefits have been / would be met with.

The contents of the enclosed statement are based on information, explanations and representations obtained from the Company and on the basis of our understanding of the business activities and operations of the Company

Our views are based on facts and assumptions indicated to us and the existing provisions of tax law and its interpretations, which are subject to change or modification from time to time by subsequent legislative, regulatory, administrative, or judicial decisions. Any such changes, which could also be retrospective, could have an effect on the validity of our views stated herein. We assume no obligation to update this statement on any events subsequent to its Issue, which may have a material effect on the discussions herein.



This report including enclosed annexure are intended solely for your information and for the inclusion in the Prospectus or any other Issue related material in connection with the proposed initial public issue of the Company and is not to be used, referred to or distributed for any other purpose without our prior written consent.

For R A Maru & Associates.,
Chartered Accountants
(Firm Registration No. 141914W)

Rumeet Anil Maru.
Proprietor
Membership No: 166417

Place: Mumbai
Date: July 14, 2018



ANNEXURE TO THE STATEMENT OF TAX BENEFITS

The information provided below sets out the possible special tax benefits available to the Company and the Equity Shareholders under the Income Tax Act 1961 presently in force in India. It is not exhaustive or comprehensive and is not intended to be a substitute for professional advice. Investors are advised to consult their own tax consultant with respect to the tax implications of an investment in the Equity Shares particularly in view of the fact that certain recently enacted legislation may not have a direct legal precedent or may have a different interpretation on the benefits, which an investor can avail.

YOU SHOULD CONSULT YOUR OWN TAX ADVISORS CONCERNING THE INDIAN TAX IMPLICATIONS AND CONSEQUENCES OF PURCHASING, OWNING AND DISPOSING OF EQUITY SHARES IN YOUR PARTICULAR SITUATION.

A. SPECIAL TAX BENEFITS TO THE COMPANY

NIL

B. SPECIAL TAX BENEFITS TO THE SHAREHOLDER

NIL

Note:

1. All the above statements are as per the current tax laws and will be available only to the sole / first name holder where the shares are held by joint holders.
2. The above statement covers only certain relevant direct tax law benefits and does not cover any indirect tax law benefits or benefit under any other law.
3. This statement is only intended to provide general information to the investors and is neither designed nor intended to be a substitute for professional tax advice. In view of the individual nature of the tax consequences, the changing tax laws, each investor is advised to consult his or her own tax consultant with respect to the specific tax implications arising out of their participation in the Issue.
4. We have not commented on the taxation aspect under any law for the time being in force, as applicable, of any country other than India. Each investor is advised to consult its own tax consultant for taxation in any country other than India.



SECTION V – ABOUT THE ISSUER COMPANY

INDUSTRY OVERVIEW

The information in this chapter has been extracted from the websites of and publicly available documents from various sources. The data may have been re-classified by us for the purpose of presentation. Neither we nor any other person connected with this Issue has independently verified the information provided in this chapter. Industry sources and publications, referred to in this chapter, generally state that the information contained therein has been obtained from sources generally believed to be reliable but their accuracy, completeness and underlying assumptions are not guaranteed and their reliability cannot be assured, and, accordingly, investment decisions should not be based on such information.

OVERVIEW OF THE GLOBAL AND INDIAN ECONOMY

Global Scenario

The global economy remains sluggish heading into 2018, but the growth outlook is nevertheless somewhat stronger than in recent years. On the positive side, we anticipate a few bright spots in the global economy, such as the US and Indian economies, and the marginal recovery of the Brazilian and Russian economies in 2017. Much of this boost will only be short term, however, so the base case forecast is flat over the next five years, with average annual growth rate of 3% projected through 2021. This very modest recovery will be uneven. South Asia, Sub-Saharan Africa and East Asia will see the highest level of dynamism over the next five years. On the negative side, growth in the developed market regions will continue to be weak, and Latin America will underperform relative to other emerging market regions.

(Source:

https://www.atearney.com/web/the-purchasing-chessboard/article/-/asset_publisher/9AutfSQfJm6Y/content/global-economic-outlook-2017-2021-the-all-too-visible-hand/236833)

Figure 1

Global economic growth will strengthen marginally this year

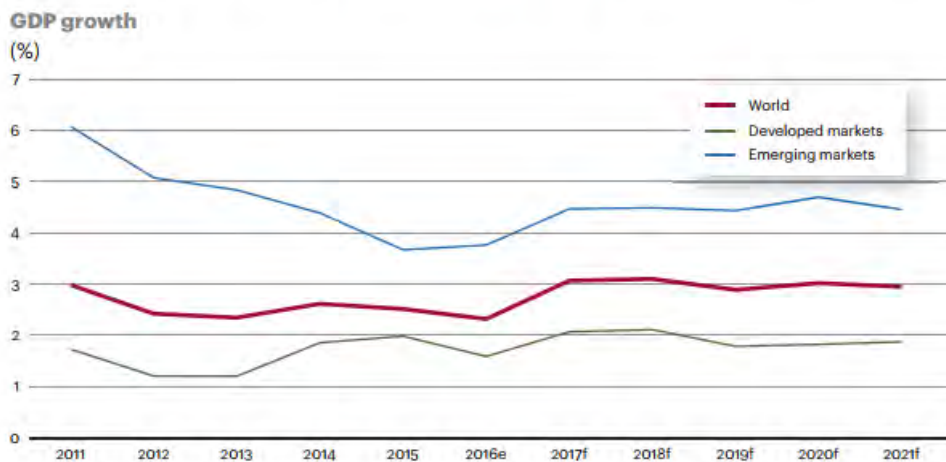

Notes: GDP is measured at market exchange rates. Developed markets are those that the IMF characterizes as "advanced economies" and emerging markets are those that the IMF characterizes as "emerging market and developing economies."
Sources: International Monetary Fund, Oxford Economics, Economist Intelligence Unit; A.T. Kearney analysis

(Source:

https://www.atearney.com/web/the-purchasing-chessboard/article/-/asset_publisher/9AutfSQfJm6Y/content/global-economic-outlook-2017-2021-the-all-too-visible-hand/236833)



The pickup in growth projected in the April 2017 World Economic Outlook (WEO) is strengthening. The global growth forecast for 2017 and 2018—3.6 percent and 3.7 percent, respectively—is 0.1 percentage point higher in both years than in the April and July forecasts. Notable pickups in investment, trade, and industrial production, coupled with strengthening business and consumer confidence, are supporting the recovery. With growth outcomes in the first half of 2017 generally stronger than expected, upward revisions to growth are broad based, including for the euro area, Japan, China, emerging Europe, and Russia. These more than offset downward revisions for the United States, the United Kingdom, and India.

Growth prospects for emerging and developing economies are marked up by 0.1 percentage point for both 2017 and 2018 relative to April, primarily owing to a stronger growth projection for China. The country's 2017 forecast (6.8 percent, against 6.6 percent in April) reflects stronger growth outturns in the first half of 2017 as well as more buoyant external demand. For 2018, the revision mainly reflects an expectation that the authorities will maintain a sufficiently expansionary policy mix to meet their target of doubling real GDP between 2010 and 2020. Growth forecasts have also been marked up for emerging Europe for 2017, reflecting stronger growth in Turkey and other countries in the region, for Russia for 2017 and 2018, and Brazil in 2017.

The US economy is projected to expand at 2.2 percent in 2017 and 2.3 percent in 2018. The projection of a continuation of near-term growth that is moderately above potential reflects very supportive financial conditions and strong business and consumer confidence. The downward revision relative to the April WEO forecasts (of 2.3 and 2.5 percent for 2017 and 2018, respectively) reflects a major correction in US fiscal policy assumptions. Given the significant policy uncertainty, IMF staff's macroeconomic forecast now uses a baseline assumption of unchanged policies, whereas the April 2017 WEO built in a fiscal stimulus from anticipated tax cuts. Over a longer horizon, US growth is expected to moderate. Potential growth is estimated at 1.8 percent, reflecting the assumption of continued sluggish growth in total factor productivity and diminished growth of the workforce due to population aging.

(Source: World Economic Outlook –International Monetary Fund -October 2017 Report)

Indian Scenario

India has emerged as the fastest growing major economy in the world as per the Central Statistics Organisation (CSO) and International Monetary Fund (IMF) and it is expected to be one of the top three economic powers of the world over the next 10-15 years, backed by its strong democracy and partnerships.. Indian economy is expected to grow at a rate of 6.7 per cent in the year 2017-18 and in the next financial year 2018-19 the economy is expected to grow at a rate of 7.2 per cent. The improvement in India's economic fundamentals has accelerated in the year 2015 with the combined impact of strong government reforms, Reserve Bank of India's (RBI) inflation focus supported by benign global commodity prices.

(Source: <https://www.ibef.org/economy/indian-economy-overview>)

During September 2017, eight core infrastructure industries grew by 5.2 per cent, as compared to 4.9 per cent growth in August 2017 and 5.3 per cent growth in September 2016. The growth of core industries during April-September 2017 was 3.3 per cent, as compared to 5.4 per cent growth during the same period last year.

Overall growth in the Index of Industrial Production (IIP) was 3.8 per cent in September 2017, as compared with 4.3 per cent growth in August 2017 and 5.0 per cent growth in September 2016. During April-September 2017, IIP growth was 2.5 per cent as compared to growth of 5.9 per cent during the same period last year.

Foreign exchange reserves were US\$ 398.8 billion as on October 27, 2017, as against US\$ 370 billion in March 2017. *(Source: Indian Economic Development and Growth Monthly Economic Report- www.ibef.org)*

Economic growth is projected to remain strong and India will remain the fastest growing G20 economy. The increase in public wages and pensions will support consumption. Private investment will recover gradually as excess capacity diminishes, and the landmark Goods and Services Tax and other measures to improve the ease of doing business are being implemented. However, large non-performing loans and high leverage of some companies are holding back investment. Monetary policy is projected to remain tight as inflation expectations have still not fully adjusted down. The need to reduce the relatively high public-debt-to-GDP ratio leaves little room for fiscal stimulus.

(Source: <http://www.oecd.org/eco/outlook/economic-forecast-summary-india-oecd-economic-outlook-june-2017.pdf>)



INTRODUCTION TO PIPE SUPPORTS

Pipe Supports

Pipe is held either from above by hangers or supports of various types on which it rests. *Hangers are also referred to as supports.*

There are a number of typical pipe supports that can be installed to support dead weight loads, and restrain the pipe for thermal and dynamic loads. The designs are only limited by the imagination of the engineer and designer, as literally thousands of different designs have been used for special purposes. Pipe is rested on or secured to a support member usually of a standard structural shape (I-beam, wide flange beam, angle, channel etc.). The pipe may be secured to this member with a pipe support.

Pipe supports and hangers are devices which transfer the loads from the pipe or the structural attachment to the supporting structure or equipment. They include rod hangers, spring hangers, sway braces, turnbuckles, struts, anchors, saddles, rollers, brackets, and sliding supports. Structural attachments are elements that are welded, bolted, or clamped to the pipe, such as clips, lugs, clamps, clevises, and stops.

The correct and economical selection of the supports for any piping system usually presents difficulties of varying degrees, some relatively minor and others of a more critical nature. Proper support selection should be the objective of all phases of design and construction.

(Source: <http://wermac.org/steel/pipesupports.html>)

Typical Pipe Shoe

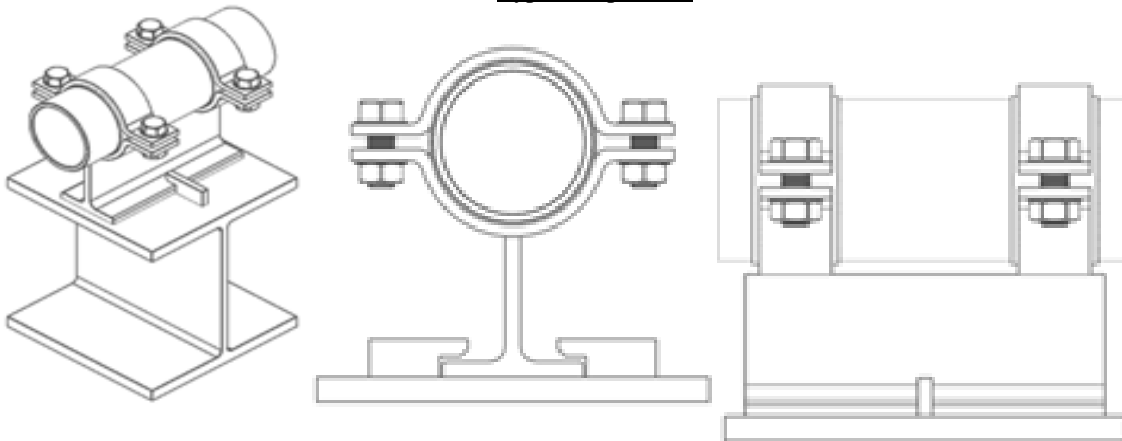



Typical Dummy Leg Support

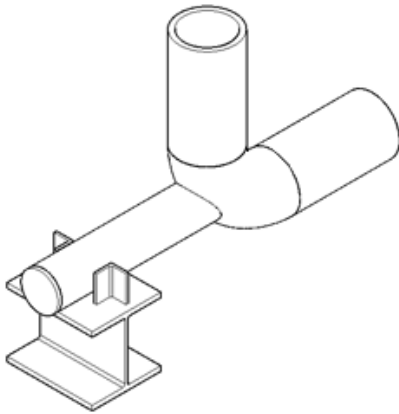

Typical Rod Hanger

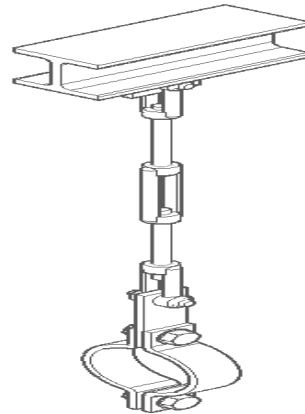

(Source: <http://wermac.org/steel/pipesupports.html>)

Pipe Supports standards

There code ASME B 31.3 specifies under clause 321.1.1 the layout and design of piping and its supporting elements shall be directed toward preventing the following:

- Piping stresses in excess of those permitted in the Code
- Leakage at joints
- Excessive thrusts and moments on connected equipment (such as pumps and turbines)
- Excessive stresses in the supporting (or restraining) elements
- Resonance with imposed or fluid-induced vibrations
- Excessive interference with thermal expansion and contraction in piping which is otherwise adequately flexible
- Unintentional disengagement of piping from its supports
- Excessive piping sag in piping requiring drainage slope
- Excessive distortion or sag of piping (e.g., thermoplastics) subject to creep under conditions of repeated thermal cycling
- Excessive heat flow, exposing supporting elements to temperature extremes outside their design limits

Determination of Support locations

Support locations are dependent on many considerations, such as pipe size, piping configuration, the location of heavy Valves and fittings, and the structure that is available for support. Following rules of thumb will help when doing the flexibility analysis and operation and maintenance:

- As much as possible, attach supports to straight pipe rather than elbows, other fittings, Valves, flanges or instruments, but provide supports near instruments, and other devices that are likely to be removed for maintenance.
- Provide space for adding loops to piping near load sensitive equipment, e.g. in pump suction lines.
- Consider the need to add friction reducing slides between the piping and support steel.
- Support piping such that spools to be removed for equipment maintenance can be removed without adding temporary supports.
- Minimize the use of spring hangers.



Determination of Loads and Movements

The anticipated movement at each support point dictates the basic type of support required. Each type of support selected must be capable of accommodating movements.

It is a good practice to select first the most simple or basic rigid support type and to add to the complexity only as conditions warrant. No advantage will be realized in upgrading a support when a simpler, more economical type can be shown to satisfy all the design requirements.

Both vertical and horizontal movement must be evaluated. When piping vertical movement is small, the use of simple rod hangers should be adequate. With small vertical movement and significant horizontal movement, the simple rod hanger will still suffice, provided the overall length is sufficient to keep the angular swing of the rod within reasonable limits—normally accepted as being 4° from the vertical.

When one is calculating the total movement experienced by the support, both horizontal displacements and the vertical displacement must be combined and normalized to the axis of the support. Consideration should be given to relocating the upper connection some percentage (usually two-thirds) of the total movement as a means for reducing the angularity in the hot position.

For piping supported from below, some form of slide must be incorporated to provide for the horizontal movement; or, in the case of ensured longitudinal movement, a pipe roll may be used. Rollers are usually only used on long runs of piping supported on racks such as found in refinery piping.

Suspended hangers with considerable horizontal movement and low headroom will require either single- or double direction trolleys or rollers. Where both longitudinal and lateral movements are large, consideration may be given to the use of a single-direction trolley oriented on the resultant movement vector.

OFTEN USED PIPE SUPPORTS

Anchors

A rigid support that restricts movement in all three orthogonal directions and all three rotational directions. This usually is a welded stanchion that is welded or bolted to steel or concrete.

Two types of anchors exist: fixed and directional. Fixed anchors are used in locations where all movement of a line must be prevented. In piping terms this is called a fixed point. The most common way to anchor a pipe is to weld the pipe directly to a support or structural member. If the pipe to be anchored is insulated, first a pipe shoe is welded to the pipe and then the shoe is welded to the steel structure.

Directional anchors are used to force movement to occur in one direction while preventing it from occurring in the opposite direction. Directional anchors are used to direct a pipe's movement away from buildings, structures, equipment etc.



Fixed Anchor

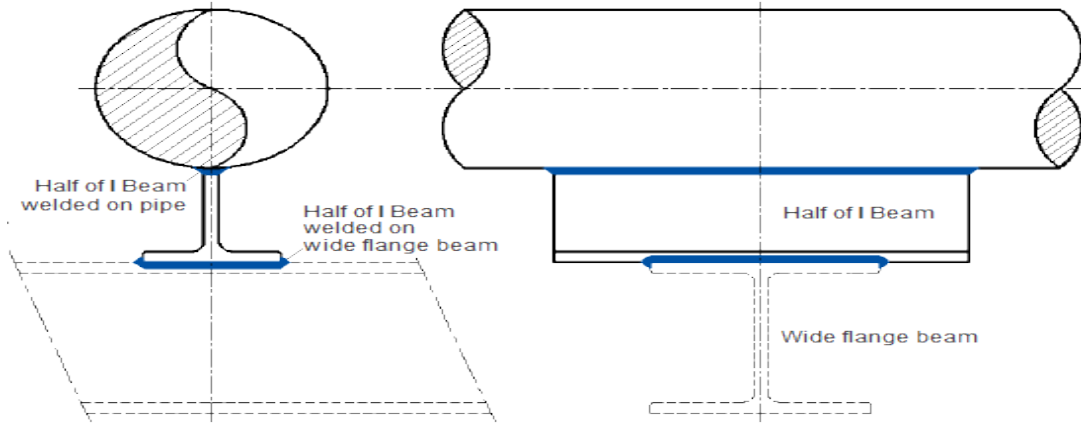

Directional Anchor

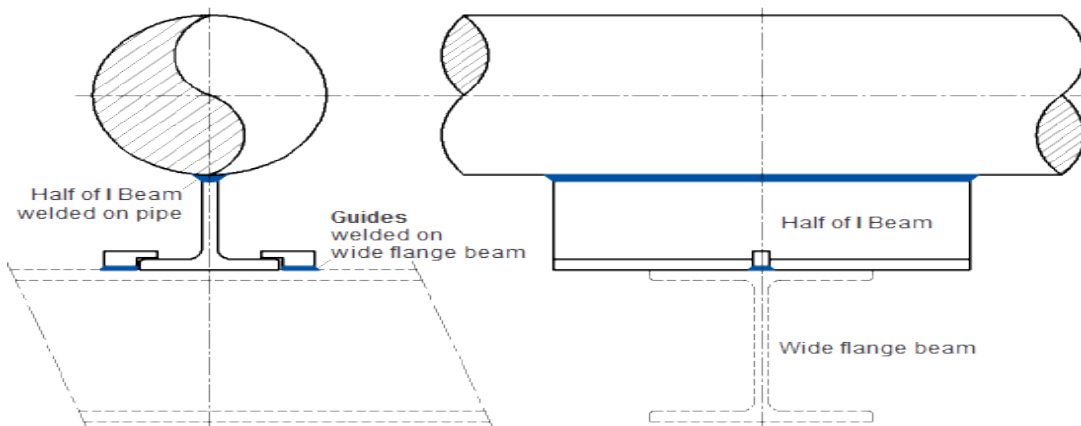



DUMMY LEG SUPPORTS

A dummy leg is an extension piece welded to an elbow in order to support a pipe line, and rests or anchors on some steel member.

Pipe size, length and wall thickness of the pipe-extension depends on several factors such as the total load, the parent pipe line size etc. *See typical dummy leg image on the right of this page.*

HANGER RODS

A vertical pipe support that incorporates a rod. It may be a rigid, variable spring or constant support hanger. Hanger is a term that often means quite different things to different people.

Rod hangers or pipe hanger's attaches to the pipe by a U bolt, a clevis, and a pipe clamp etc. to structural steel above. The rod hanger provides support in the vertical direction and allows limited motion in the horizontal direction. Adjustment in the vertical direction can be accomplished by threads or a turnbuckle. *See hanger rod image on the right of this page.*

GUIDES

When total restriction of pipe movement is not required, pipe guides are used.

Pipe guides confine movement along the pipe's lineal axis. In piping terms this is called a sliding point. They are used primarily to maintain proper line spacing in a pipe rack and they prevent lateral or sideways movement.

Unlike the pipe anchor which is welded to the pipe and steel structure, the guide allows pipe to slide lengthwise between two angle shapes. When the pipe is supported on shoes, the angle shapes are positioned on either side of the shoe. *For an image of guides see directional anchor above.*

CONSTANT LOAD HANGER

A specially engineered hanger that is designed to travel through many inches of vertical travel with a minimal change in support load. There are different styles and types depending on the manufacturers. Per MSS SP-58 a constant support hanger can be within specification and still have a load variation of plus minus 6% through the travel range.

Some suppliers claim a tighter tolerance on the load variation. Constant hangers and constant supports are used for piping and related components where higher levels of vertical travel occur. Their job is to transfer the working load over the whole travel area while maintaining constancy, i.e., without any considerable deviations. The functional precision of the constant hanger is decisive for the favorable long term behaviour of the components concerned.

Constant hangers compensate for vertical movement caused by thermal expansion. Via constant hangers, the respective piping loads are constantly absorbed and transferred with no significant deviation over the whole range of movement. *Significant deviations would act as harmful and uncontrolled extra loads in the system.*



Horizontal constant with top attachment which is bolted directly to the bottom of the steel as shown above.

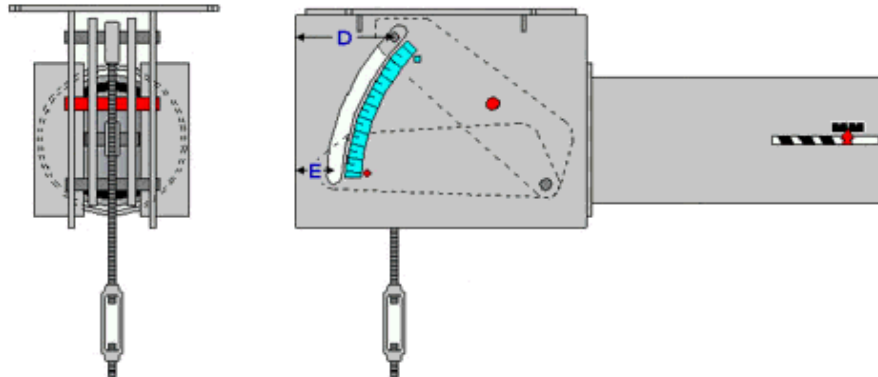

VARIABLE SPRING HANGERS AND SUPPORTS

A helical coil that supports dead weight load. The support load changes as the spring moves through its range at a specified spring rate. This support can be a hanger above the pipe, or a floor support below the pipe.

To prevent constraints in the system, thermal expansion in the piping and other piping components must not be hindered. The piping must therefore be supported in a correspondingly elastic manner.

To compensate for slight vertical displacements in the piping, spring components are used as supports. The functioning of these components is based on preset helical coil springs which exert a variable supporting load over the whole range of movement corresponding to the given spring characteristics.

Load variations resulting from this are limited through corresponding specifications based on stress calculations for the piping - this depends on the sensitivity of the system.

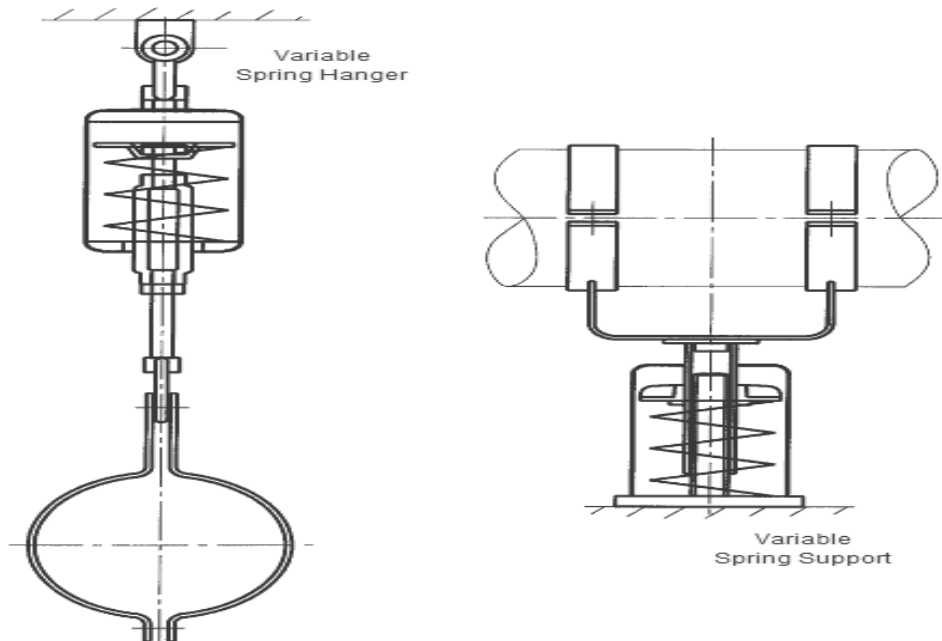



HYDRAULIC SHOCK ABSORBERS

The use of shock absorbers (snubbers) is preferred in thermally operating piping systems. In a dynamic event, shock absorbers instantaneously form a practically rigid restraint between the protected component and the structure. Resulting dynamic energy can at once be absorbed and harmlessly transferred.

Through the special function of the shock absorbers, thermal displacements during normal operation remain unhindered.

Hydraulic Shock Absorber (Snubber)



(Source: <http://wermac.org/steel/pipesupports.html>)

OVERVIEW OF STEEL INDUSTRY

Steel is crucial to the development of any modern economy and is considered to be the backbone of human civilization. The level of per capita consumption of steel is treated as an important index of the level of socio-economic development and living standards of the people in any country. It is a product of a large and technologically complex industry having strong forward and backward linkages in terms of material flows and income generation. All major industrial economies are characterized by the existence of a strong steel industry and the growth of many of these economies has been largely shaped by the strength of their steel industries in their initial stages of development.

India's economic growth is contingent upon the growth of the Indian steel industry. Consumption of steel is taken to be an indicator of economic development. While steel continues to have a stronghold in traditional sectors such as construction, housing and ground transportation, special steels are increasingly being used in engineering industries such as power generation, petrochemicals and fertilizers. India occupies a central position on the global steel map, with the establishment of new state-of-the-art steel mills, acquisition of global scale capacities by players, continuous modernization and up gradation of older plants, improving energy efficiency and backward integration into global raw material sources.

India is currently the world's fourth largest producer of crude steel (knocking to be the third largest by the year end) and is expected to become the second largest producer by 2020. Steel production in India has increased from 81 million tonnes (mt) in 2013-14 to 88 mt in 2014-15 with the capacity being increased from 100 mt in 2013-14 to 110 mt in 2014-15. The steel sector contributes nearly 2% of the country's GDP and employs over 6 lakh people. The per capita consumption of total finished steel in the country has risen from 51 kg in 2009-10 to about 60 kg in 2014-15.

Steel industry derives its demand from other important sectors like infrastructure, aviation, engineering, construction, automobile, pipes and tubes etc. With the Indian economy poised for its next wave of growth under the reforms being unleashed in the last one year, there lies tremendous opportunity for the Indian steel industry to prosper and grow exponentially.

The Indian steel industry is largely iron-based through the blast furnace (BF) or the direct reduced iron (DRI) route. Indian steel industry is highly consolidated. About 50% of the crude steel capacity is resident with integrated steel producers (ISP). But the changing ratio of hot metal to crude steel production indicates toward the increasing presence of secondary steel producers in the eco-system.

(Source: http://www.indiasteelexpo.in/industry_overview.php)

Steel Production in India Has Been Growing at a Fast Pace

- In FY17, crude steel production in India was 97.42 MT, with the total crude steel production growing at a CAGR of 5.49 per cent over the last 6 years.



- The steel sector contributes over 2 per cent to the GDP of the nation and provides 20 lakh jobs in the country.
- During April-November 2017, crude steel and finished steel production in India stood at 66.70 MT and 76.356 MT respectively.
- As of March 2017, the capacity utilisation of steel producers is set to increase with strong export demand and signs of revival in domestic sales. Companies like JSW and Essar Steel have experienced a sharp increase in steel manufacturing in the last 2 months
- Steel manufacturing output of India is expected to increase to 128.6 MT by 2021, accelerating the country's share of global steel production from 5.4 per cent in 2017 to 7.7 per cent by 2021.
- India's steel output is expected to grow at a CAGR of 8.9 per cent during 2017-21 and India is expected to become top global steel producer^.

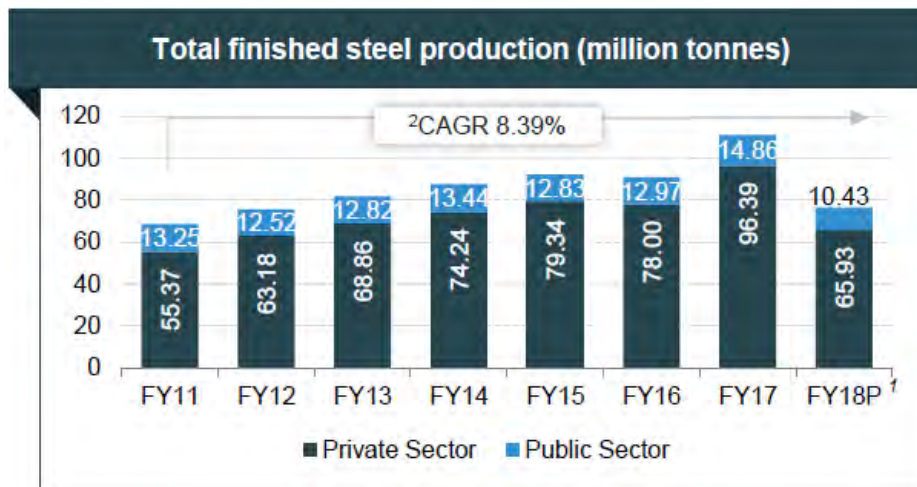

(Source: Steel Sectoral Report- December 2017 – ibef.org)

Advantage India

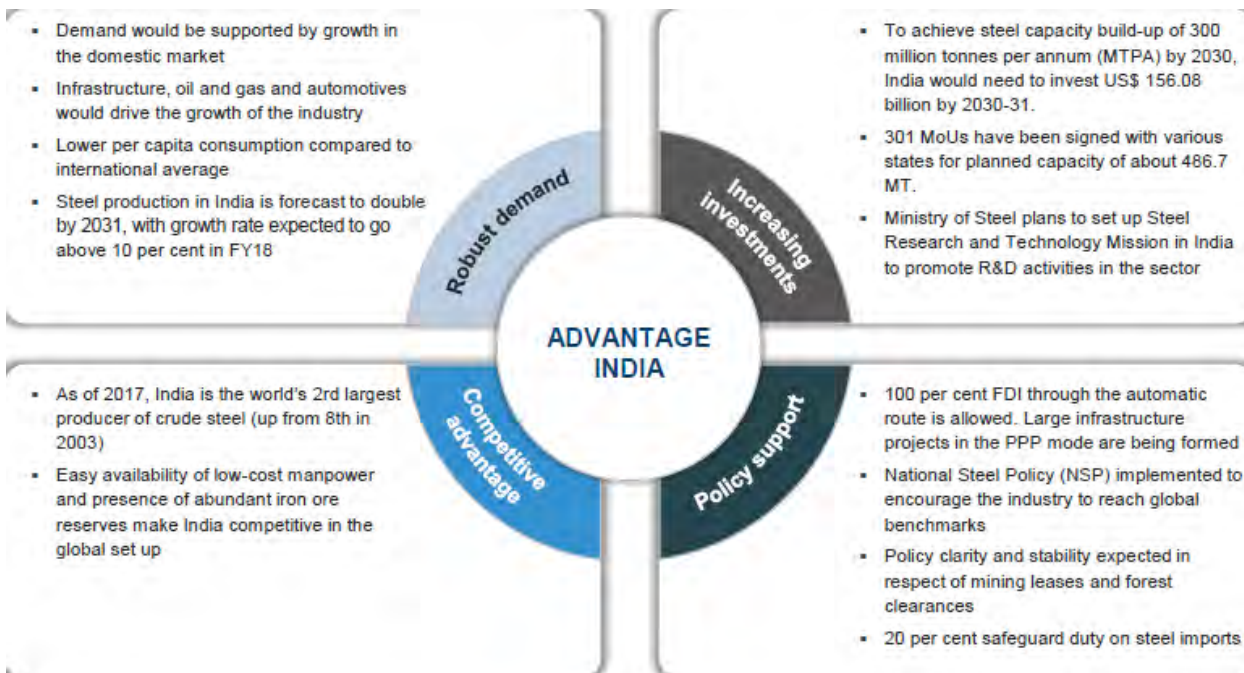

(Source: Steel Sectoral Report- December 2017 – ibef.org)



Government Initiatives

Some of the other recent government initiatives in this sector are as follows:

- Steel demand is set to rise in the coming period owing to increased public sector spending by the Government of India.
- The Union Cabinet, Government of India has approved the National Steel Policy (NSP) 2017, as it seeks to create a globally competitive steel industry in India. NSP 2017 targets 300 million tonnes (MT) steel-making capacity and 160 kgs per capita steel consumption by 2030.
- Metal Scrap Trade Corporation (MSTC) Limited and the Ministry of Steel have jointly launched an e-platform called 'MSTC Metal Mandi' under the 'Digital India' initiative, which will facilitate sale of finished and semi-finished steel products.
- The Ministry of Steel is facilitating setting up of an industry driven Steel Research and Technology Mission of India (SRTMI) in association with the public and private sector steel companies to spearhead research and development activities in the iron and steel industry at an initial corpus of Rs 200 crore (US\$ 30 million).

Road ahead

India is expected to overtake Japan to become the world's second largest steel producer soon, and aims to achieve 300 million tonnes of annual steel production by 2025-30.

India is expected to become the second largest steel producer in the world by 2018, based on increased capacity addition in anticipation of upcoming demand, and the new steel policy, that has been approved by the Union Cabinet in May 2017, is expected to boost India's steel production.* Huge scope for growth is offered by India's comparatively low per capita steel consumption and the expected rise in consumption due to increased infrastructure construction and the thriving automobile and railways sectors.

(Source: www.ibef.org)

FABRIC AND TEXTILE INDUSTRY OVERVIEW

Global Scenario

The global textile business & clothing business 2017 is estimated to be worth about the US \$4395 billion and also, global trade in textiles & clothing stands around the US \$360bn.

According to the world trade organization forecast, Global trade is set to expand by 3.3% this year & 4% in next year.

The success of the modern industry of world textiles is dependent largely upon continuing major investment in innovation and invention.

The reason which forces the textile business to the promotion is increasing the share of Technical Textiles.

Globally, the technical textiles contribute to about 27% of the world textile industry, in some of the western countries its share is even 50 % while in India it is 11%.

Transparency market research (TMR) forecasts that the global technical textile market is growing with CAGR of 3.3% from 2012.

In 2018, the global technical textiles market will reach a market value of US\$160.38 billion from US\$133.93 billion in 2012.

All the above clearly suggests a better than expected outlook for our textile industries. In fact, there already are indications that 2016 is going to be a good year



Global Apparel Consumption

The current Global apparel market is estimated at approximately US\$ 1.15 trillion which forms nearly 1.8% of the world GDP.

Almost 75% of this market is concentrated in EU-27, USA, China and Japan.

The next largest markets are Brazil, India, Russia, Canada, and Australia, in descending order with a share of approximately 18%.

(Source: www.textilemates.com/textile-business-global-market-present-future)

Indian Scenario

India's textiles sector is one of the oldest industries in Indian economy dating back several centuries. Even today, textiles sector is one of the largest contributors to India's exports with approximately 13 per cent of total exports. The textiles industry is also labour intensive and is one of the largest employers. The textile industry has two broad segments. First, the unorganised sector consists of handloom, handicrafts and sericulture, which are operated on a small scale and through traditional tools and methods. The second is the organised sector consisting of spinning, apparel and garments segment which apply modern machinery and techniques such as economies of scale.

The textile industry employs about 45 million people directly and 20 million people indirectly. India's overall textile exports during FY 2015-16 stood at US\$ 40 billion.

The Indian textiles industry is extremely varied, with the hand-spun and hand-woven textiles sectors at one end of the spectrum, while the capital intensive sophisticated mills sector at the other end of the spectrum. The decentralised power looms/ hosiery and knitting sector form the largest component of the textiles sector. The close linkage of the textile industry to agriculture (for raw materials such as cotton) and the ancient culture and traditions of the country in terms of textiles make the Indian textiles sector unique in comparison to the industries of other countries. The Indian textile industry has the capacity to produce a wide variety of products suitable to different market segments, both within India and across the world.

Market Size

The Indian textiles industry, currently estimated at around US\$ 120 billion, is expected to reach US\$ 230 billion by 2020. The Indian Textile Industry contributes approximately 2 per cent to India's Gross Domestic Product (GDP), 10 per cent of manufacturing production and 14 per cent to overall Index of Industrial Production (IIP).

Indian khadi products sales increased by 33 per cent year-on-year to Rs 2,005 crore (US\$ 311.31 million) in 2016-17 and is expected to exceed Rs 5,000 crore (US\$ 776.33 million) sales target for 2018-19, as per the Khadi and Village Industries Commission (KVIC).

The total area under cultivation of cotton in India is expected to increase by 7 per cent to 11.3 million hectares in 2017-18, on account of expectations of better returns from rising prices and improved crop yields during the year 2016-17.

Indian exports of locally made retail and lifestyle products grew at a compound annual growth rate (CAGR) of 10 per cent from 2013 to 2016, mainly led by bedding bath and home decor products and textiles#. The Government of India targets textile and garment sector exports at US\$ 45 billion for 2017-18.

Investment

The textiles sector has witnessed a spurt in investment during the last five years. The industry (including dyed and printed) attracted Foreign Direct Investment (FDI) worth US\$ 2.55 billion during April 2000 to June 2017.



Some of the major investments in the Indian textiles industry are as follows:

- Future Group is planning to open 80 new stores under its affordable fashion format, Fashion at Big Bazaar (FBB), and is targeting sales of 230 million units of garments by March 2018, which is expected to grow to 800 million units by 2021.
- Raymond has partnered with Khadi and Village Industries Commission (KVIC) to sell Khadi-marked readymade garments and fabric in KVIC and Raymond outlets across India.
- Max Fashion, a part of Dubai based Landmark Group, plans to expand its sales network to 400 stores in 120 cities by investing Rs 400 crore (US\$ 60 million) in the next 4 years.

Government Initiatives

The Indian government has come up with a number of export promotion policies for the textiles sector. It has also allowed 100 per cent FDI in the Indian textiles sector under the automatic route.

Initiative will be taken into consideration by Government of India.

- The Government has planned to connect as many as 5 crore (50 million) village women to charkha (spinning wheel) in next 5 years with a view to provide them employment and promote khadi and also, they inaugurated 60 khadi outlets which were renovated and re-launched during the completion of KVIC's 60th anniversary and a khadi outlet.
- The Textiles Ministry will organise 'Hastkala Sahyog Shivirs' in 421 handloom-handicrafts clusters across the country which will benefit over 1.2 lakh weavers and artisans.
- The Gujarat government's decision to extend its textile policy by a year is set. It is believed to attract Rs 5,000 crore (US\$ 50 billion) of more investment in sectors across the value chain. The government estimates addition till now of a million units of spindle capacity in the spinning sector and setting up of over 1,000 units in technical textiles.

The key initiatives announced in the Union Budget 2017-18 to boost the textiles sector are listed below:

- Encourage new entrepreneurs to invest in sectors such as knitwear by increasing allocation of funds to Mudra Bank from Rs 1,36,000 crore (US\$ 20.4 billion) to Rs 2,44,000 crore (US\$ 36.6 billion).
- Upgrade labour skills by allocating Rs 2,200 crore (US\$ 330 million)

Road Ahead

The future for the Indian textile industry looks promising, buoyed by both strong domestic consumption as well as export demand. With consumerism and disposable income on the rise, the retail sector has experienced a rapid growth in the past decade with the entry of several international players like Marks & Spencer, Guess and Next into the Indian market. The apparel market in India is estimated to grow at a Compound Annual Growth Rate (CAGR) of 11.8 per cent to reach US\$ 180 billion by 2025.

High economic growth has resulted in higher disposable income. This has led to rise in demand for products creating a huge domestic market. The domestic market for apparel and lifestyle products, currently estimated at US\$ 85 billion, is expected to reach US\$ 160 billion by 2025.

The Indian cotton textile industry is expected to showcase a stable growth in FY 2017-18, supported by stable input prices, healthy capacity utilisation and steady domestic demand.

(Source: www.ibef.org)



OUR BUSINESS

The following information is qualified in its entirety by, and should be read together with, the more detailed financial and other information included in this Prospectus, including the information contained in “Risk Factors”, “Management’s Discussion and Analysis of Financial Condition and Results of Operations” and “Financial Statements” on pages nos. 15, 174, and 151 of this Prospectus, respectively. The financial figures used in this section, unless otherwise stated, have been derived from our Company’s restated audited financial statements. Further, all references to ‘Saketh Exim Limited’, ‘SEL’, ‘the Company’, ‘our Company’ and ‘the Issuer’ and the terms ‘we’, ‘us’ and ‘our’, are to Saketh Exim Limited.

Unless stated otherwise, the financial data in this section is as per our financial statements prepared in accordance with Indian GAAP set forth elsewhere in this Prospectus. In this section only, any reference to “we”, “us” or “our” refers to Saketh Exim Limited.

OVERVIEW

Our Company manufactures and fabricates various steel products which are meant for its application in Pipe Support Systems, HVAC Systems, Anti-vibration System and Equipments for Industrial, Commercial, Utility and OEM Installations. We manufacture various engineering products, metal and base metal products like G. I. nuts, various types of bolts, clamps, hangers etc. Further our Product Portfolio includes all types of bathroom pipes, fittings, bathroom accessories and sanitary wares.

The following diagram depicts the breakup of revenue, percentage-wise for financial year ended March 31, 2018 on the basis of Manufacturing and Trading segments.

Revenue Model	
Manufacturing (61.22%) ⁽¹⁾	Trading (38.78%) ⁽¹⁾

⁽¹⁾Percentage (%) is calculated as a percentage of Total Sale of Products.

Certain products manufactured by us are certified by Underwriter’s Laboratory Inc. (U.S.A) and FM Global Approved (U.S.A) which are meant to be used for Fire Sprinklers System Installations. Further, we are certified by Dun & Bradstreet which helps us in growing relationships through their global database and helps us in exploring the new potential customers.

We are certified by ISO 9001:2015 for manufacturing of various products i.e. UL and FM approved Pipe Hangers and Support Systems, Anti vibration products, Rubber support inserts, valves, S.S. Floor Drains. This certification confirms to the Quality Management System of our Company in relation to the manufacturing of various products.

Our Company has 3 manufacturing units located at Vasai. These manufacturing units are strategically located providing locational advantages. Our Company has installed various plant and machinery at our manufacturing facilities for manufacturing and fabrication of the varied products. For further details regarding machineries, please refer to “Our Business - Plant and Machinery” on page no. 108 of this Prospectus.

Our Company exports its products to various geographies such as USA and various countries in Middle East serving to various companies of several industries. We have a good customer base in India as well as internationally. These customers have been a part of the growth story of our Company which we believe is essentially due to the product quality and customer centric approach of our Company. We also have a good customer base in India for the products manufactured by us.

Our Company is even engaged in trading of textile products. We trade into fancy shirting and finish fabrics. Based on the orders received from our customers for the textile products, we order the exact requirement from our suppliers and make the final product available to our customers



Our revenue from operations for the financial year ending 2015-16, 2016-17 and 2017-18 are ₹ 4,668.77 lakhs, ₹ 5,132.56 lakhs and ₹ 6,182.36 respectively. Our Net Profit after tax for the above mentioned periods i.e. in the last 3 years are ₹ 77.02 lakhs in F. Y. 2015-16, ₹ 95.55 lakhs in F.Y. 2016-17 and ₹ 107.12 lakhs in F.Y. 2017-18. The above Net profit after tax shows an increase of 24.06% and 12.11% respectively over the 3 years.

OUR STRENGTHS

Well Experienced Management

Our Company is being led by Mr. Sanjay Patel, having an experience of 36 years. We have an experienced and professional management team with strong execution capabilities and considerable experience in this industry.

We have employed suitable technical and support staff to manage key areas of activities allied to operations. Further our Company has entered into an agreement for supply of job workers wherein the labourers employed are skilled for the job. We believe the skill sets of our labourers give us the flexibility to adapt to the needs of our clients and help satisfy the technical requirements of the products that we manufacture.

Our team is well qualified and experienced in the engineering and steel industry and has been responsible for the growth of our operations. We believe the stability of our management team and the industry experience brought in by our KMPs and employees, coupled with their strong client relationships, will enable us to continue to take advantage of future market opportunities and expand into new markets. For further details of the educational qualifications and experience of our Management Team and our Key Managerial Personnel please refer the chapter titled “*Our Management*” beginning on page no. 128 of this Prospectus.

Compliance with Quality Standards & Consistency in Quality and Service

We follow stringent quality standards in all our manufacturing units to ensure that our products meet the required standards. Our products adhere to quality standards and our manufacturing units are ISO 9001:2015 certified, which confirms that our products conform to the Quality Management System Standard.

UL and FM Approved Product range meeting with International Standards

Our Company is certified by Underwriter’s Laboratory Inc. (U.S.A) and FM Global Approved (U.S.A), wherein we have received UL and FM Approvals from Directors of North American Certification Programs and from AVP, Manager-Fire Protection of FM Approvals respectively. These certifications provide a worldwide recognition for the Products approved by the Authorities.

The products manufactured by us should meet the industry standard set for their design and quality. We follow stringent measures to ensure the compliance of these standards for meeting the International norms. Regular audits are conducted at our premises to ensure the compliance of the parameters set.

Customized Product Development

Our Company offers customization facilities to all the customers as per their particular requirements and specifications. Our manufacturing teams focus on the precise demand of the customer and design the products accordingly. This provides complete satisfaction to our customers and enables us to expand our business from existing customers and also address a larger base of potential new customers

Strong Customer Base

Our Company exports its products to various geographies such as USA and various countries in Middle East serving to various companies of several industries. We have a good customer base in India as well as internationally which includes international Companies like Technopro Middle East FZCO, Hamat Alezz Trading Est., Bin Dasmal General Trading Co LLC., Al Sayed Center A/C & Refrigeration Materials etc. These customers have been a part of the growth story of our



Company which we believe is essentially due to the product quality and customer centric approach of our Company. We also have a good customer base in India for the products manufactured by us.

Scalable Business Model

Our Business model is customer centric and order driven, and requires optimum utilisation of our existing facilities, assuring quality supply of raw materials and achieving consequent economies of scale. The business scale generation is basically due to development of new markets both domestic and international by exploring marketing expertise and by maintaining the consistent quality output. We believe that this business model has proved successful and scalable for our Company.

OUR STRATEGIES

Increase in Order-taking Appetite by augmenting our working capital base

Our business operations are working capital intensive. In order to effectively expand our products portfolio, Business arenas and also increase in number of verticals and explore various geographical locations, along with the existing facilities we need to have access to a larger amount of liquid funds and sufficient working capital.

We believe there is growing trend towards steel industry considering electrical and mechanicals installations. Alongwith the increasing demand, we expect to increase our order taking appetite thus increasing our volumes, revenues and scale of operations and we will require substantial working capital for the same. It is hence our strategy to raise funds from this issue and augment our fund based working capital capabilities. We believe that companies with high liquidity on their balance sheet would be able to better exploit market opportunities.

Hence, in order to effectively operate the aforementioned additional facilities along with the existing facilities we need to have access to a larger amount of liquid funds and sufficient working capital. For further details of the proposed working capital requirements of the company, kindly refer to the Chapter titled “*Objects of the Issue*” beginning on page no. 71 of this Prospectus.

Expansion of product range

We intend to continue to diversify our existing products by manufacturing various other products which are used in the application of Fire Fighting, plumbing and other mechanical installations. Presently, our Company is manufacturing and fabricating various steel products for Industrial, Commercial, Utility and OEM Installations. We manufacture various engineering products, metal and base metal products like G. I. nuts, various types of bolts, clamps, hangers etc.

Going forward, we intend to expand our current product portfolio and we intend to manufacture screws, nuts, bolts and washers in-house. This expansion in the Product portfolio will serve as a one-stop solution provider for engineering products meant to be used in Pipe Support Systems, HVAC Systems, Anti-vibration System and Equipments etc.

Expand our distribution network and exports

Our existing reach in international countries has been critical to our export sales. We also have a market in India for the goods manufactured by us. We aim to further develop our domestic sales networks in two ways: firstly nurturing existing relationships with clients and secondly by creating new distribution channels in non-penetrated geographies considering various cities.

As on March 31, 2018, about 58.11% of total business comes from export sales of manufactured products, 1.24% from local sales of manufactured goods and balance comes from trading of textile products. Our company is focusing on increasing growth in the export markets. Exports brings in better realization of margins, prompt delivery due to faster and planned pace of projects, better payment terms and access to larger markets. This also reduces the risk of dependence on a single market and ensures that any slowdown in the market would not affect overall growth and performance of our Company.



Optimal Utilization of Resources:

Our Company constantly endeavours to improve our manufacturing and fabrication process by using latest technology in machineries to optimize the utilization of resources. We regularly analyze our existing raw material procurement and manufacturing/ fabrication processes to identify the areas of bottlenecks and correct the same. This helps us in improving efficiency and putting resources to optimal use.

Strengthening our Brand

Our strategic objective is to increase the presence of our brand in the existing markets and positioning our brand in the future markets that we intend to capture. We intend to consequently improve our economic of scale whereby we can develop a brand expansion strategy that will help us to increase our market share of exports, business growth and profitability. Further, we shall also use the appropriate pricing strategy to persuade our existing and newer consumers to buy our branded products.

We intend to invest in developing and enhancing our brand image, through brand building efforts, communication and promotional initiatives such as advertisements in media, participation in industry events, exhibitions etc. This is a continuous exercise, which would increase the brand image resulting in an increase of sales and profitability.

Diversifying and increasing penetration in markets

Our Company's products are sold in domestic market and global market. The domestic market also offers opportunities in term of sub-geographic penetration and product/market diversification. Our Company will seek to grow its marketing reach domestically to explore hither to untapped markets and segments as part of its strategy to mitigate market risk and widen growth prospects. Our Company will continue to explore opportunities in various countries where it can supply value added products to enhance its geographical reach.

Enhancing production and product quality

We believe quality is an important factor when it comes to any product or service. With the high market competition, quality product at an affordable price has become the market differentiator for almost all products and services. We constantly work to enhance the existing quality of our products by optimizing the existing production processes and introducing new processes. We train our employees to consistently design and deliver client focused solutions.

DETAILS OF OUR BUSINESS

LOCATION

Registered Office

Plot No. PAP-D 146/147, TTC M.I.D.C, Turbhe Industrial Area, Opp. Balmer Lawrie Vannleer, Navi Mumbai - 400407.

OUR MANUFACTURING FACILITIES / UNITS

UNIT I

It is located at Unit 1/B, Badrinath, Ground Floor, Tungreshwar, IND Complex, S.R. No. 1, Hissa No. 8, Sativali Village, Vasai East - 401208

Our Company began its operations with this unit in the year 2013. This commercial unit is spread across an area of 7000 sq ft bearing building and shed area. The manufacturing unit houses various semi automated and manually operated plant and machinery for manufacturing and related process.



UNIT II

It is located at Unit 3, APL House, Tungareshwar, IND Estate, S. No. 1 Hissa No. 8, Sativali Village, Vasai, East - 401208

This commercial unit comprises of two industrial buildings admeasuring 10,500 sq. ft. and 3,000 sq. ft. The manufacturing unit houses various semi automated and manually operated plant and machinery for manufacturing process alongwith electroplating process related plant and machinery.

These locations provide us an ease of business activities since all the units are located at Vasai and it gives us an advantage of moving the products from one unit to another. For further details of ownership / lease of the above locations, please refer to “*Our Business – Properties*” on page no. 112 of this Prospectus.

UNIT III

It is located at Plot No.3, Survey No. 62, Hissa (18) (1) (2) N.H. No.8, Ganesh Indl Estate, Village- Sativali, Taluka Vasai, Dist. Palghar. This commercial unit admeasuring 2,925 sq. ft. comprises of electroplating process which houses semi automated and manually operated plant and machinery for finishing the products manufactured.

Our Products:

Our Company has a varied product portfolio and a wide scope including jobbing, machining, manufacturing and fabrication of various engineering goods, steel products, nuts, bolts, various types of clamps, saddle hose clamps, various types of hangers, various types of Bolts etc. Further our product portfolio includes all types of bathroom pipes, fittings, bathroom accessories and sanitary wares.

These products are used in the applications for Fire fighting, Plumbing, HVAC, Mechanical and Electrical Installations.

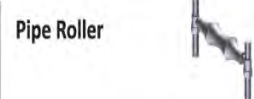
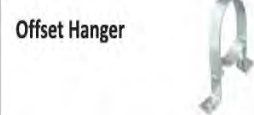
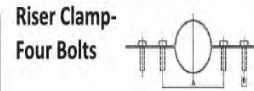
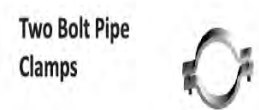
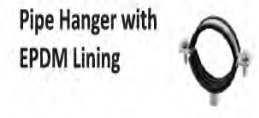



Union Type Flexible Connector



Flexible Metallic Pump Connector



Two Piece Channel Clip (strut Pipe | tube Clamp / Strut Mounting Pipe Guide)



Protection Plate



Threaded Rods



Fasteners



Slotted Channel



Spring Hanger



Drop In Anchor & Draw In Anchor



HVAC Accessory



Closed Spring Mount



Single Arch Expansion Joint



Metallic Expansion Joints



Floating Flange Expansion Joint



Floor Drains



Shower Drains



Double Arch Expansion Joints



Anti Vibration Pads



Gate Valve



Check Valve



Turret Mount Duct Mount



Cup Spring Mount



Butterfly Valve



Y Strainer



Enclosed Spring Isolator

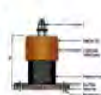

Open Spring Mountings



Di-electric Unions



Wedge Anchor Bolt



Inertia Base



Spring Hanger





Business Process of Manufacturing of Steel Products

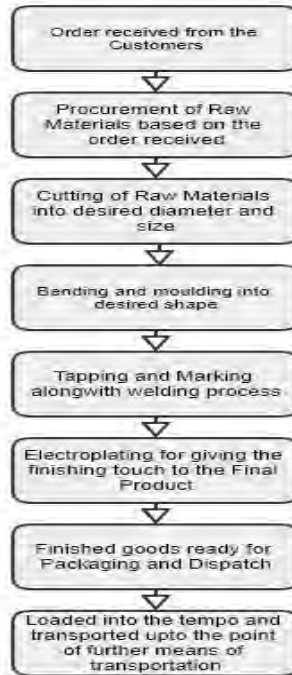

Manufacturing Process of certain Major Products

- **Manufacturing Process of Hangers**

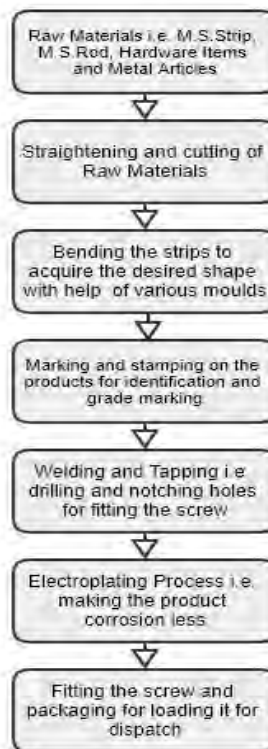



- **Manufacturing Process of U Bolts**

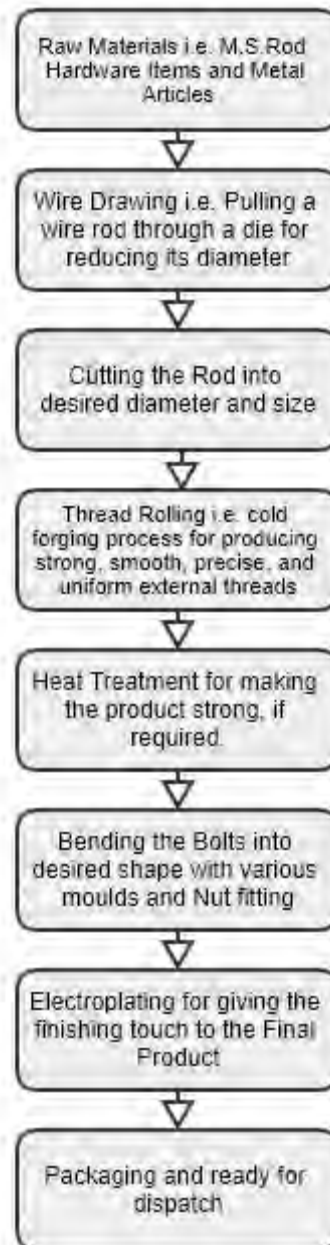



- **Manufacturing Process of Threaded Rod**

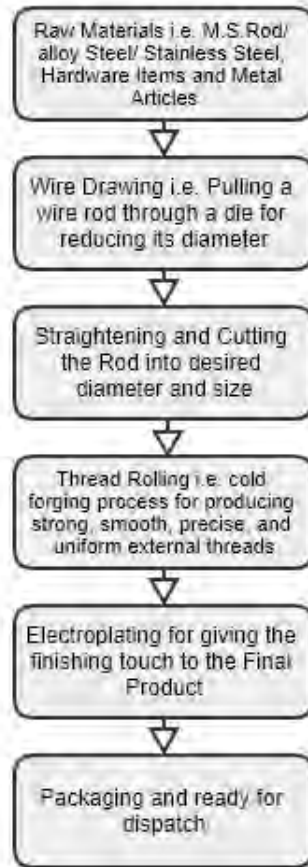

Raw Material Procurement:

Our raw materials consist of steel products primarily M.S. Strips, M.S. Rods, Alloy steel, stainless steel and other hardware items and metal articles. We have been able to secure timely supply of required raw material for our existing activity. Raw material is easily available in the domestic market and no difficulty is envisaged in sourcing of the raw material.

Processing activity

The processing activity starts once the raw materials are procured from the market. The processing activity consists of Wire drawing which is passed through automated machines, wherein the wires are cut into desired size. The operator checks the first few pieces to confirm that the output is as per specification. After the necessary quality check is complete then the mass production cutting takes places.

Once the wires are cut into the desired size, the operator inputs the strips which are bent with the help of various moulds. Thus strips are moulded into various shapes as desired by the customer. These individual strips are further marked and stamped. Further these strips are tapped i.e. holes are made for fitting the screws and welding process is carried out.

Once the final product is ready, they undergo a process called “Electroplating”, wherein the final product is processed by a coating of a thin layer of another metal which gives the final product a better appearance and further protects it from corrosion, wear or rust.



Electroplating Process:

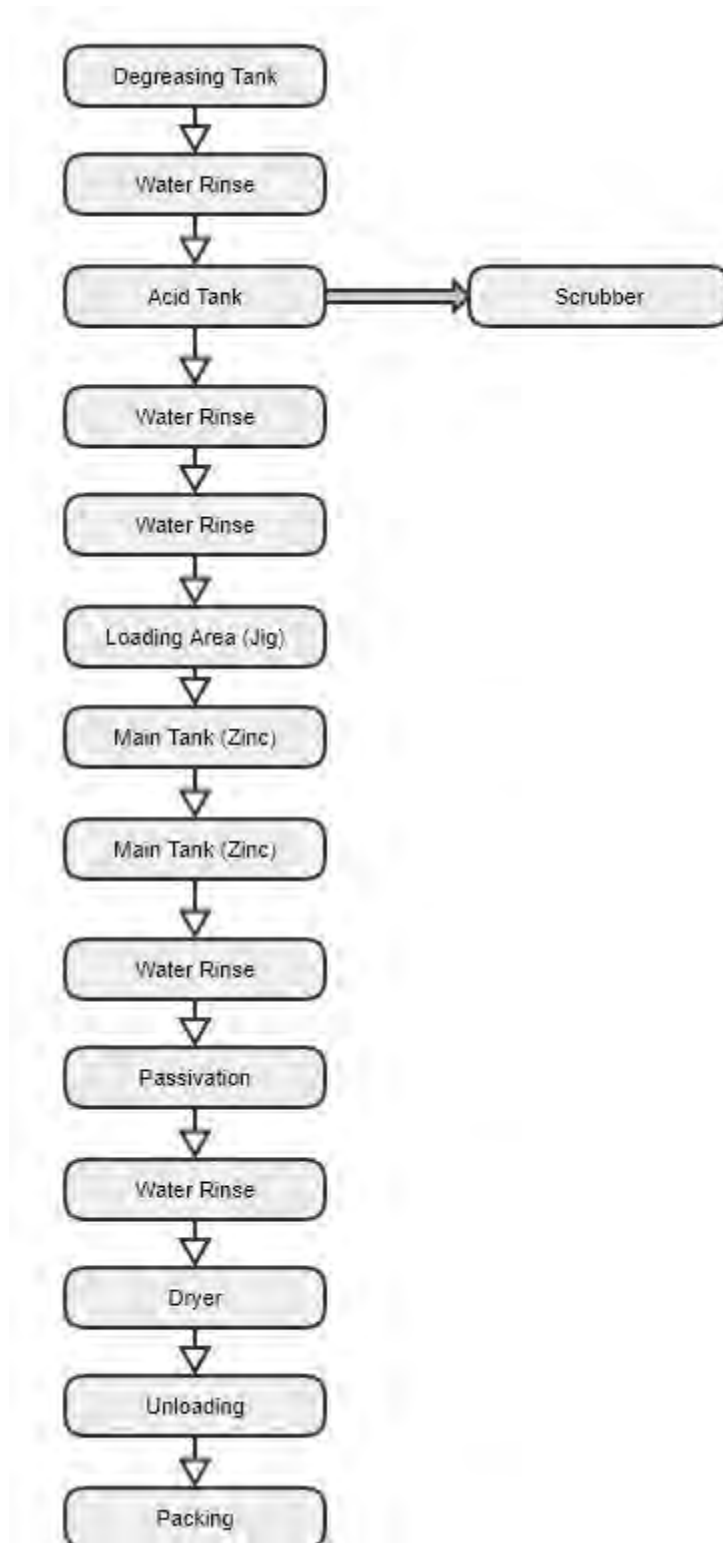

Electroplating Process is carried out because the abrasion or excessive heat caused by welding and other processes of fabrication destroys the protective layer of the product and exposes it to corrosion.



The manufactured products are passed through a process of electroplating, wherein they are passed through a Degreasing Tank for removal of oil and other greases which are settled on the product during the fabrication process. Thus this help in cleaning the product. After basic cleaning, it is passed through another tank which is filled with water for rinsing it. Further the rinsed product is passed through Acid Tank which consists of Hydrochloric Acid for removal of rust or further removal of dust particles and other substance. This Acid Tank is connected with scrubber, wherein this Acid is neutralized and after neutralizing the same, it is released in the environment in form of fumes.

In order to make the manufactured product usable, it is further passed through water tanks twice after the rust removal process. These products are hanged in rods by means of jig, which are passed through main tanks containing Zinc, wherein the electrolysis process takes place, causing zinc to deposit on the rods forming a layer on the product. After this electrolysis process, the product is passed through water for rinsing and further passed through passivation process wherein

Slowly and naturally a passive layer develops on the surface of the product as the chromium at the surface reacts with oxygen in the air to produce chromium oxide. This layer is invisible and only a few molecules thick but it provides a barrier to prevent corrosion of the final product. The final product is further passed through water tank for rinsing and later passed through dryer, making it ready for packing.

Quality Control

The finished products are checked internally for quality with respect to size, shape and quantity, before it is finally approved and sent for packing. Further the Finished products are sent to external labs for quality checking purpose.

Finished and Packing

Once the above electroplating process and quality checking process is completed the finished products are sent for packing. While packing the products are checked manually.

Dispatch

The products are packed into boxes and further into containers for dispatch. These containers are loaded into trucks which are unloaded at the point of mode of transportation based on the location of the customer. The goods are transported by mode of Road, water and Air.

Trading Business

Our Company is even engaged in trading of textile products. We trade into fabric, fancy shirting's and finished fabrics based on the requirement of the customer. Based on the orders received from our Customers for the textile products, we order the exact requirement from our suppliers and make the final product available to our Customers. The Final product is directly transported to the ultimate customer from the place of our supplier. We are dependent on a few logistical service providers for supply of textile products from the place of supplier to the destination of the ultimate buyer.



Fabric



Fancy Shirting



Finish Fabric



Our Operations

Our Company is primarily engaged in the manufacture of various engineering goods, nuts, bolts, various types of clamps, saddle hose clamps, various types of hangers. Additionally our products portfolio includes all type of bathroom pipes, fittings, bathroom accessories and sanitary wares. Additionally, Our Company is also engaged in trading of textile Products.

The details about the breakup of revenue, percentage-wise for last three years on the basis of manufacturing and trading activities are as follows:

(₹ in lakhs)

Sr. No.	Particular	For year ending March 31,					
		2018		2017		2016	
		Revenue (₹)	(%) ⁽¹⁾	Revenue (₹)	(%) ⁽¹⁾	Revenue (₹)	(%) ⁽¹⁾
1.	Manufacturing Related	3,499.52	59.34%	2,068.82	41.73%	1,817.96	39.99%
2.	Trading Related	2,397.72	40.66%	2,888.78	58.27%	2,727.74	60.01%

⁽¹⁾ Percentage (%) is calculated as a percentage of Total Sale of Products.

Our Major Customers

The percentage of income derived from our top customers during the financial year 2017-18 and 2016-17 is given below:

Sr. No.	Particular	For year ending March 31, 2018		For year ending March 31, 2017	
		Revenue (₹ in lakhs)	(%) ⁽¹⁾	Revenue (₹ in lakhs)	(%) ⁽¹⁾
1.	Income from Top 5 Customers (%)	2,793.34	47.37%	2,862.78	57.75%
2.	Income from Top 10 Customers (%)	3,694.44	62.65%	3,469.25	69.98%

⁽¹⁾ Percentage (%) is calculated as a percentage of Total sale of Products

The percentage of income derived from our top customers in trading segment during the financial year 2017-18 and 2016-17 is given below:

Sr. No.	Particular	For year ending March 31, 2018		For year ending March 31, 2017	
		Revenue (₹ in lakhs)	(%) ⁽¹⁾	Revenue (₹ in lakhs)	(%) ⁽¹⁾
3.	Income from Top 5 Customers (%)	1304.24	54.40%	1,755.13	60.76%
4.	Income from Top 10 Customers (%)	2397.71	100.00%	2,888.78	100.00%

⁽¹⁾ Percentage (%) is calculated as a percentage of sales of trading segment.

Although our top 10 customers may vary from one reporting period to another depending on the requirements of a particular industry segment, we believe, we have experienced a high degree of returning customers over the years, which reflects the value proposition provided by us. We constantly try to address the needs of our customers for maintaining a long term working relation with the customers, in order to get continuous business.

Plant and Machinery

The details of the Plant & Machinery are as follows:

- Press Machines
- Cutting and Straightening Machines
- Feeder and Straightening Machines
- Bending Machines
- Threading Machines
- Electro- Plating Plant (Manual)
- Electro- Plating Plant (Semi- Automatic)



Utilities

Power & Fuel

Our manufacturing unit has adequate power supply from Maharashtra State Electricity Distribution Co. Ltd. The following is the sanctioned power for our manufacturing unit:

Details of Location	Sanctioned Load
Unit I	522 KW
Unit II	448 KW
Unit III	22 KW

In addition to the said sanctioned power, the company has installed DG Sets as standby arrangement, which is used in case of need/ shortage of the power or in case of requirement of additional power.

Water

Water requirement for the manufacturing and allied processes is minimal and the same is procured locally from Bore-well/ Tanker.

Waste Disposal Management

The waste generated from the cutting process is generally sold as scrap. The leftover scrap which is very minimal considering the process of our manufacturing activities, are packed in a suitable manner and loaded in the dumpers/ tractors/ trucks etc. for the purpose of disposal.

Export and Export Obligation

The total exports of the company for the last three fiscal years i.e. 2017-18, 2016-17 and 2015-16 are ₹ 3426.68, ₹ 2,046.84 and ₹ 1,746.07 lakhs respectively.

There are no Export Obligations as on date of this Prospectus.

Collaborations

The Company has so far not entered into any technical or financial collaboration agreement.

Environmental management / Health, Safety and Environment

We are committed to protecting the health and safety of our employees and workers working in our factories. We have policies in place for health and safety for our workmen which have the following salient features:

- Compliance with relevant Safety and Statutory Regulations and Rules both in letter and in spirit
- Ensuring cleanliness of work place in compliance with the relevant regulations
- Providing work force with helmets, gloves, aprons, face masks and other appropriate tools as required
- Knowledge/instructions on work procedures and safety precautions
- Conducting classes on safety, first aid training, fire fighting, mock drills etc.
- Ongoing assessment on the status of safety, health and environment at the work place and take appropriate measures to improve the same.
- Obligation and responsibility on every employee to perform the tasks ensuring complete safety.



Marketing Set-up

Our Company believes that the quality of their product and services are up to the mark and that's the major reason for being awarded with the orders. Our Company has a skilled team for marketing which personally indulges in formation of marketing strategies apt for the right promotion of the products manufactured by us as well as for the fabric and textile products traded by us. The marketing strategies are for both inland and foreign market.

Export Marketing is directly handled by Mr. Sachin Sawant for marketing of goods manufactured by us. Further, for international business the company has appointed overseas agents who inform about the potential customers in foreign market. In some countries the Company is marketing through its foreign agents or sometimes marketing directly through net media. Further our company participates in exhibitions held in the foreign countries for promotion of our products and maintaining a cordial relation with our customers and also with a view to broaden our customer base by having new potential clientele. Additionally, we are certified by Dun & Bradstreet which helps us in growing relationships through their global database and helps us in exploring the new potential customers.

We believe our relationship with the clients is strong and established as we receive repeated orders for the products manufactured by us as well as for the fabric and textile products traded by us. To retain our customers, our team, which comprises of people with vast experience regularly interacts with them and focuses on gaining an insight into the additional needs of the customers.

Intellectual Property

We conduct our business under the trademark "Tembo Seven Star" and "iE TALiA". We also use following mentioned trademarks, which are registered with the Trade Mark Registry, Mumbai:

Particulars of the Mark	Word/Label mark	Applicant / Owner	Trademark/ Application Number	Class
	Device	Saketh Exim Private Limited	2268470	6
	Device	Saketh Exim Private Limited	2642287	6
	Device	Saketh Exim Private Limited	3717194	6
TEMBO	Device	Saketh Exim Private Limited	2102325	6

Accreditations/ Certifications/ Awards and Achievement

Accreditations Obtained

Accreditation	Certificate No.	Validity period	Description
ISO 9001:2015 ⁽¹⁾	10Q/SEN/08003	Until August 02, 2019	Certifying the quality management system, confirming the scope of the applicability of the certificate as manufacturing of "UL and FM approved Pipe Hangers and Support Systems, Anti-vibration products, rubber support inserts, valves, S.S. Floor Drains."



(1) Assessed and certified by SGI Management Pvt. Ltd. Along with, joint accreditation is obtained from JAS-ANZ Accreditation system of Australia and New Zealand and IAF (Member of Multilateral Recognition arrangement)

Certifications Obtained

Certification	Certificate No.	Certificate Date	Description
FM Approval	0003060652	March 23, 2017	Certificate of compliance certifying products along with Model No. ⁽¹⁾
UL Certification	20161026-EX16250	October 26, 2016	Certificate of compliance certifying products after investigating the products as per the standards mentioned in the certificate. ⁽²⁾
UL Certification	20170531-EX16250	May 31, 2017	Certificate of compliance certifying products after investigating the products as per the standards mentioned in the certificate. ⁽³⁾
UL Certification	HLX.EX27325	November 14, 2016	Certificate of compliance for certifying Butterfly valves.
FM Approval	0003056409	April 25, 2016	Certificate of compliance certifying products along with Model No. ⁽⁴⁾

Scope of the above mentioned certificates:

(1) Certification of products like Swing Check Valves (grooved end connections) with Model No. VCG01 and VCG02132, Butterfly Valves (grooved end connections) with Model No. SE-VGB01, Pipe Hanger, Beam Clamp with Model No. BC 01, Pipe Hanger, Swivel Loop Hanger with Model No. SH01 and Pipe Hanger, Clevis Hanger with Model No CH01.

(2) Certification of representative samples of Hangers, Pipes covering different models i.e. SCH: Clevis Hanger with various sizes, SH: Band Hanger with various sizes, PC-1: Pipe Clamp with various sizes and PC-2: Pipe Clamp with various sizes.

(3) Certification of representative samples of Hangers, Pipes covering different models i.e. SCH: Clevis Hanger, SH: Band Hanger, PC-1: Pipe Clamp, PC-2: Pipe Clamp, SE-USC: U Strap and SE-UB Series: U Bolt.

(4) Certification of Pipe Hanger Components including Clevis Hangers with Model CH, Loop Hangers with Model SH and Pipe Clamp Hanger with Lining with Model NCR. These products are available in varied sizes.

Besides the above mentioned certifications, Our Company is associate member of Raigad Chamber of Commerce and Industry. Our Company is a part of Dun and Bradstreet Global Database, which is beneficial for growing relationships.

Human Resource

We believe that motivated and empowered employee base is the key to our operations and business strategy. We have developed a large pool of skilled and experienced personnel.

Our Company has entered into an agreement with B.M. Electro Mechanical LLP for supply of labour for the manufacturing of Our Products. We have entered into an agreement in order to carry out the processing work by undertaking labour jobs for processing, assembling, and packing of materials for all goods manufactured by us i.e. all engineering goods including range of support clamps, hangers, U bolts etc. Currently, our company has at its disposal a dynamic team of qualified and seasoned technocrats and engineers.

We employ 39 employees as on March 31, 2018, consisting of accountants, trainees and other staff.



The details of manpower employed as on March 31, 2018 are as under:

Sr. No.	Category	Number of Employees
1.	Executive Director	1
2.	Key Managerial Personnel (KMP)	8
3.	Other Employees (Office staff)	30
	Total	39⁽¹⁾

⁽¹⁾ The number of employees mentioned above does not include the count of job workers.

Competition

There is increasing competition in the pipe support hanger & related metal industry as well as textile Industry. Our Company manufactures various engineering products, metal and base metal products like G. I. nuts, various types of bolts, clamps, hangers etc. We are engaged in manufacturing of steel products which are meant for its application in Pipe Support Systems, HVAC Systems, Anti-vibration System and Equipments for Industrial, Commercial, Utility and OEM Installations. Further our Product Portfolio includes all types of bathroom pipes, fittings, bathroom accessories and sanitary wares.

We face competition from various local domestic and international players. This industry is an unorganised industry and is fragmented with many small and medium sized companies and entities, which manufactures these products at various levels. Further, we face competition from the global market since our Company is mainly export oriented for the products manufactured by us.

Over the years, we have developed a platform for our products in the International market due to various marketing strategies adopted by us. Additionally, we are certified by Dun & Bradstreet which helps us in growing relationships through their global database and helps us in exploring the new potential customers. We believe that our Company will not only maintain but further enhance its position in this Industry. Our reputation is based on the quality of the products manufactured by us and timeliness of delivery of the products.

Further, we are also engaged in trading of fabric and textile related products. Textile being a large global industry we face competition from various players in the market. The industry is largely unorganized and fragmented with many small and medium-sized companies and entities. We intend to continue competing vigorously to capture more market share and manage our growth in an optimal way.

We believe that the principal factors affecting competition in our business include client relationships reputation, the abilities of our management and operating team and market focus. Our success also depends on our ability to understand the preferences of our existing and prospective customers. Our competencies are however in delivering timely executions well within the quality parameters.

Properties

Registered Office

Leasehold Property

Sr. No.	Name of the Licensor	Premises Leased and area	Tenure of the Lease	Lease Premium (₹ in lakhs)	Purpose
1.	M.I.D.C. (Lessor/ Owner)	PAP-D146/147-M.I.D.C, Turbhe Industrial Area, Opp - Balmer Lawrie Vannleer, Navi Mumbai, MH-400407	From 14.02.2011 (99 years)	Rent: ₹ 0.16/-, per annum Lease Premium: ₹ 7.82	Registered Office



Manufacturing Units

Tenancy

Sr. No.	Name of the Licensor	Premises Leased and area	Tenure of the Lease	Lease Premium (₹ in lakhs)	Purpose
1.	Mr. Satish Hazarilal Agarwal (Partner of M/s Vikram Industries)	Unit 1/B, Badrinath, Ground Floor, Tungareshwar, IND Complex1, Block Sector: Sativali, Vasai, East- 401208	From 01.09.2016 till 31.08.2021	Rent: ₹ 66,000/-, per month Rent Deposit: ₹ 3,00,000/-	Manufacturing Plant
2.	Mr. Satish Hazarilal Agarwal (Partner of M/s Vikram Industries)	APL House, Tungareshwar Industrial Complex, SR No. 1. H. No. 8 on Land bearing Survey No. 62, Vasai East, Palghar- 401208	From 01.06.2017 till 28.02.2020	Rent: ₹ 2,40,000/-,per month Rent Deposit: ₹ 5,00,000/-	Manufacturing Plant
3.	Mr. Shoaib Shakir Nuri (Partner of M/s Rainbow Dyeing & Printing Works)	Gala No. 4, Plot No. 3, Survey No. 62 Hissa No. 18(1), (2), N.H. No.8 Ganesh Industrial Estate, Sativali Village, Vasai	From 01.03.2016 till 28.02.2019	Rent: ₹ 51,525/-, per month Rent Deposit: ₹ 3,00,000/-	Manufacturing Plant

Insurances

Our Company generally maintains insurance covering our stocks, machineries, assets etc. at such levels that we believe to be appropriate. We maintain insurance for standard fire and special perils policy which provides insurance cover against loss or damage by fire, earthquake, terrorism etc. and also, which we believe, is in accordance with customary industry practices.

The insurance policies covered by the company are:

Sr. No.	Name of the Insurance Company	Type of Policy	Validity Period	Policy No.	Sum Insured (₹ in lakhs)	Premium p.a. (₹ in lakhs)
1.	Bajaj Allianz	Standard Fire & Special Perils Policy ⁽¹⁾	23.10.2017 to 22.10.2018	OG-18-1907-4001-00000965	150.00	0.18
2.	Bajaj Allianz	Standard Fire & Special Perils Policy ⁽²⁾	14.11.2017 to 13.11.2018	OG-18-1907-4001-00001002	350.00	0.15
3.	Bajaj Allianz	Standard Fire & Special Perils Policy ⁽³⁾	05.11.2017 to 04.11.2018	OG-18-1907-4001-00001001	900.00	1.00
4.	Bajaj Allianz	Standard Fire & Special Perils Policy ⁽⁴⁾	26.12.2017 to 25.12.2018	OG-18-1907-4001-00001205	55.00	0.06

⁽¹⁾ Standard Fire and Special Perils Policy covering risk on Plant and Machinery including Electrical fittings, tools, spare parts pertaining to traded, situated at our Engineering workshop located at APL House, Tungareshwar Industrial Complex, Sr. No.1, H.No.8, Sativali Village East, Vasai, India.

⁽²⁾ Standard Fire and Special Perils covering risk occupancy including Super Structures i.e. Buildings, and including Furniture and Fixtures i.e. Office Equipments and other accessories in the premises located at Plot No. PAP D/146 & 147, T.T.C. Industrial Area, Opp Balmer Lawrie Vanleer Co, Turbhe MIDC, Navi Mumbai - 400703, India.

⁽³⁾ Standard Fire and Special Perils covering risk on Plant and Machinery and stock at our manufacturing unit, which is located at Unit-1, B-Badrinath, Ground Floor, Tungareshwar Industrial Complex, Sativali Village, Vasai East- 401208, India.



- (4) Standard Fire and Special Perils covering risk on Plant and Machinery and stock at our Engineering workshop, which is located at Plot No. 3, Survey No. 62 Hissa No. 18(1), (2), N.H. No.8 Ganesh Industrial Estate, Sativali Village, Vasai.



KEY REGULATIONS AND POLICIES

In carrying on our business as described in the section titled “Our Business” on page no. 96 of this Prospectus, our Company is regulated by the following legislations in India. The following description is a summary of the relevant regulations and policies as prescribed by the Government of India and other regulatory bodies that are applicable to our business. The information detailed in this Chapter has been obtained from the various legislations, including rules and regulations promulgated by the regulatory bodies and the bye laws of the respective local authorities that are available in the public domain. The description of regulations and policies set out below may not be exhaustive and are only intended to provide general information to the investors and are neither designed nor intended to be a substitute for professional legal advice. The statements below are based on the current provisions of Indian law, and the judicial and administrative interpretations thereof, which are subject to change or modification by subsequent legislative, regulatory, administrative or judicial decisions. For details of Government Approvals obtained by the Company in compliance with these regulations, kindly refer to the Chapter titled “Government and Other Key Approvals” beginning on page no. 197 of this Prospectus.

A. LABOUR LAWS

The Factories Act, 1948

The Factories Act, 1948 ("**Factories Act**") seeks to regulate labour employed in factories and makes provisions for the safety, health and welfare of the workers. The term ‘factory’, as defined under the Factories Act, means any premises which employs or has employed on any day in the previous 12 (twelve) months, 10 (ten) or more workers and in which any manufacturing process is carried on with the aid of power, or any premises wherein 20 (twenty) or more workmen are employed at any day during the preceding 12 (twelve) months and in which any manufacturing process is carried on without the aid of power. An occupier of a factory under the Factories Act, means the person who has ultimate control over the affairs of the factory. The occupier or manager of the factory is required to obtain a registration for the factory. The Factories Act also requires *inter alia* the maintenance of various registers dealing with safety, labour standards, holidays and extent of child labour including their conditions. Further, notice of accident or dangerous occurrence in the factory is to be provided to the inspector by the manager of the factory.

The following are the rules which are applicable to the Company:

- ***Maharashtra Factories Rules, 1961***

The Employees’ Compensation Act, 1923

The Employees’ Compensation Act, 1923 (“EC Act”) has been enacted with the objective to provide for the payment of compensation to workmen by employers for injuries caused by accident(s) arising out of and in the course of employment, and for occupational diseases resulting in death or disablement. The EC Act makes every employer liable to pay compensation in accordance with the EC Act if a personal injury/disablement/ loss of life is caused to a workman by accident arising out of and in the course of his employment. In case the employer fails to pay compensation due under the EC Act within 1 (one) month from the date it falls due, the commissioner appointed under the EC Act may direct the employer to pay the compensation amount along with interest and may also impose a penalty.

Payment of Gratuity Act, 1972

The Payment of Gratuity Act, 1972 provides for payment of gratuity to employees employed in factories, shops and other establishments who have put in a continuous service of 5 (five) years, in the event of their superannuation, retirement, resignation, death or disablement due to accidents or diseases. The rule of ‘five year continuous service’ is however relaxed in case of death or disablement of an employee. Gratuity is calculated at the rate of 15 (fifteen) days’ wages for every completed year of service with the employer. Presently, an employer is obliged for a maximum gratuity payout of Rs.10,00,000/- for an employee.



The Minimum Wages Act, 1948

The Minimum Wages Act, 1948 (“MWA Act”) was enacted to establish minimum wages for certain categories of employees. Under this Act, the Central and the State Governments stipulate the scheduled industries and establishments and fix minimum wages.

The following are the rules which are applicable to the Company:

- *Maharashtra Minimum Wages Rules, 1963*

Payment of Bonus Act, 1965

Pursuant to the Payment of Bonus Act, 1965, as amended, an employee in a factory or in any establishment where 20 (twenty) or more persons are employed on any day during an accounting year, who has worked for at least 30 (thirty) working days in a year, is eligible to be paid a bonus. Contravention of the provisions of the Payment of Bonus Act, 1965 by a company is punishable with imprisonment up to six months or a fine up to Rs.1,000/- or both.

The Maternity Benefit Act, 1961

The purpose of the Maternity Benefit Act, 1961 is to regulate the employment of pregnant women in certain establishments for certain periods and to ensure that they get paid leave for a specified period before and after childbirth, or miscarriage or medical termination of pregnancy. It inter alia provides for payment of maternity benefits, medical bonus and prohibits the dismissal of and reduction of wages paid to pregnant women.

The Payment of Wages Act

The Payment of Wages Act, 1936 (“PWA”) is applicable to the payment of wages to persons in factories and other establishments. PWA ensures that wages that are payable to the employee are disbursed by the employer within the prescribed time limit and no deductions other than those prescribed by the law are made by the employer.

Equal Remuneration Act, 1979

Equal Remuneration Act, 1979 provides for payment of equal remuneration to men and women workers and for prevention discrimination, on the ground of sex, against female employees in the matters of employment and for matters connected therewith.

The Sexual Harassment of Women at Workplace (Prevention, Prohibition and Redressal) Act, 2013

The Sexual Harassment of Women at Workplace (Prevention, Prohibition and Redressal) Act, 2013 (“SHWW Act”) provides for the protection of women at work place and prevention of sexual harassment at work place. The SHWW Act also provides for a redressal mechanism to manage complaints in this regard. Sexual harassment includes one or more of the following acts or behavior namely, physical contact and advances or a demand or request for sexual favors or making sexually colored remarks, showing pornography or any other unwelcome physical, verbal or non-verbal conduct of sexual nature. The SHWW Act makes it mandatory for every employer of a workplace to constitute an Internal Complaints Committee which shall always be presided upon by a woman. It also provides for the manner and time period within which a complaint shall be made to the Internal Complaints Committee i.e. a written complaint is to be made within a period of 3 (three) months from the date of the last incident. If the establishment has less than 10 (ten) employees, then the complaints from employees of such establishments as also complaints made against the employer himself shall be received by the Local Complaints Committee. The penalty for non-compliance with any provision of the SHWW Act shall be punishable with a fine extending to Rs. 50,000/-.



Child Labour (Prohibition and Regulation) Act, 1986

The Child Labour (Prohibition and Regulation) Act, 1986 (the “CLPR Act”) seeks to prohibit the engagement of children in certain employments and to regulate the conditions of work of children in certain other employments. It also prescribes hours and periods of work, holidays, the requirement of keeping a register, etc for the establishments falling under this act. A shop or a commercial establishment is included under the definition of an “establishment” according to Section 2(iv).

Contract Labour (Regulation and Abolition) Act, 1970

The Contract Labour (Regulation and Abolition) Act, 1970 (“CLRA”) is an act to regulate the employment of contract labour in certain establishments and to provide for its abolition in certain circumstances. The CLRA applies to every establishment in which 20 (twenty) or more workmen are employed or were employed on any day of the preceding 12 (twelve) months as contract labour. It also applies to every contractor who employs or who employed on any day of the preceding 12 (twelve) months, 20 (twenty) or more workmen provided that the appropriate Government may after giving not less than 2 (two) months' notice, by notification in the Official Gazette, apply the provisions of the CLRA to any establishment or contractor. Further, it contains provisions regarding Central and State Advisory Board under the CLRA, registration of establishments, and prohibition of employment of contract labour in any process, operation or other work in any establishment by the notification from the State Board, licensing of contractors and welfare and health of the contract labour. The Contract Labour (Regulation and Abolition) Central Rules, 1971 are formulated to carry out the purpose of the CLRA.

Industrial Disputes Act, 1947 and Industrial Dispute (Central) Rules, 1957

Industrial Dispute Act, 1947 and the Rules made there under provide for the investigation and settlement of industrial disputes. The Industrial Disputes Act, 1947 (“IDA”) was enacted to make provision for investigation and settlement of industrial disputes and for other purposes specified therein. Workmen under the IDA have been provided with several benefits and are protected under various labour legislations, whilst those persons who have been classified as managerial employees and earning salary beyond a prescribed amount may not generally be afforded statutory benefits or protection, except in certain cases. Employees may also be subject to the terms of their employment contracts with their employer, which contracts are regulated by the provisions of the Indian Contract Act, 1872. The IDA also sets out certain requirements in relation to the termination of the services of the workman. The IDA includes detailed procedure prescribed for resolution of disputes with labour, removal and certain financial obligations up on retrenchment. The Industrial Dispute (Central) Rules, 1957 specify procedural guidelines for lock-outs, closures, lay-offs and retrenchment.

The Employees State Insurance Act, 1948

The Employees State Insurance Act, 1948 (“ESI Act”) provides for certain benefits to employees in case of sickness, maternity and employment injury. All employees in establishments covered by the ESI Act are required to be insured, with an obligation imposed on the employer to make certain contributions in relation thereto. Employers of factories and establishments covered under the ESI Act are required to pay contributions to the Employees State Insurance Corporation, in respect of each employee at the rate prescribed by the Central Government. Companies which are controlled by the Government are exempt from this requirement if employees receive benefits similar or superior to the benefits prescribed under the ESI Act. In addition, the employer is also required to register itself under the ESI Act and maintain prescribed records and registers.

The Employees' Provident Fund and Miscellaneous Provisions Act, 1952

The Employees Provident Funds and Miscellaneous Provisions Act, 1952 (“EPF Act”) was introduced with the object to institute compulsory provident fund for the benefit of employees in factories and other establishments. The EPF Act provides for the institution of provident funds and pension funds for employees in establishments where more than 20 (twenty) persons are employed and factories specified in Schedule I of the EPF Act. Under the EPF Act, the Central Government has framed the "Employees Provident Fund Scheme", "Employees Deposit-linked Insurance Scheme" and the "Employees Family Pension Scheme". Liability is imposed on the employer and the employee to contribute to the funds



mentioned above, in the manner specified in the statute. There is also a requirement to maintain prescribed records and registers and filing of forms with the concerned authorities. The EPF Act also prescribes penalties for avoiding payments required to be made under the abovementioned schemes.

The Micro, Small and Medium Enterprises Development Act, 2006 and Industries (Development and Regulation) Act, 1951

The Micro, Small and Medium Enterprises Development Act, 2006 (“MSMED Act”) inter-alia provides for facilitating the promotion and development and enhancing the competitiveness of micro, small and medium enterprises. The Central Government is empowered to classify by notification, any class of enterprises including inter-alia, a company, a partnership, firm or undertaking by whatever name called, engaged in the manufacture or production of goods pertaining to any industry specified in the First Schedule to the Industries (Development and Regulation) Act, 1951 as: (i) a micro enterprise, where the investment in plant and machinery does not exceed Rs. 25,00,000/- (Rupees Twenty Five Lakhs Only) (ii) a small enterprise, where the investment in plant and machinery is more than Rs. 25,00,000/- (Rupees Twenty Five Lakh Only) but does not exceed Rs. 5,00,00,000/- (Rupees Five Crores Only); or (iii) a medium enterprise, where the investment in plant and machinery is more than Rs. 5,00,00,000/- (Rupees Five Crores Only) but does not exceed Rs. 10,00,00,000/- (Rupees Ten Crores Only). The MSMED Act inter-alia stipulates that any person who intends to establish, a micro or small enterprise or a medium enterprise engaged in rendering of services, may at his discretion and a medium enterprise engaged in the manufacture or production of goods as specified hereinabove, file a memorandum of micro, small or medium enterprise, as the case may be, with the prescribed authority.

Trade Union Act, 1926

The Trade Union Act, 1926 governs the disputes which arise/ may arise between employers and workmen or between workmen and workmen, or between employers and employers in connection to their employment, non-employment and the terms of employment or the conditions of labour. For the purpose of Trade Union Act, 1926, Trade Union means combination, whether temporary or permanent, formed primarily for the purpose of regulating the relations between workmen and employers or between workmen and workmen, or between employers and employers, or for imposing restrictive condition on the conduct of any trade or business etc.

B. TAX RELATED REGULATIONS

Income-tax Act, 1961

The Income-tax Act, 1961 (“IT Act”) is applicable to every Company, whether domestic or foreign whose income is taxable under the provisions of the IT Act or Rules made thereunder depending upon its “Residential Status” and “Type of Income” involved. The IT Act provides for the taxation of persons resident in India on global income and persons not resident in India on income received, accruing or arising in India or deemed to have been received, accrued or arising in India. Every Company assessable to income tax under the IT Act is required to comply with the provisions thereof, including those relating to Tax Deduction at Source, Advance Tax, Minimum Alternative Tax and like. Every such Company is also required to file its returns by September 30 of each assessment year.

Professional Tax

The professional tax slabs in India are applicable to those citizens of India who are either involved in any profession or trade. The State Government of each State is empowered with the responsibility of structuring as well as formulating the respective professional tax criteria and is also required to collect funds through professional tax. The professional taxes are charged on the incomes of individuals, profits of business or gains in vocations. The professional tax is charged as per the List II of the Constitution. The professional taxes are classified under various tax slabs in India. The tax payable under the State Acts by any person earning a salary or wage shall be deducted by his employer from the salary or wages payable to such person before such salary or wages is paid to him, and such employer shall, irrespective of whether such deduction has been made or not when the salary and wage is paid to such persons, be liable to pay tax on behalf of such person and employer has to obtain the registration from the assessing authority in the prescribed manner. Every person liable to pay tax under these Acts (other than a person earning salary or wages, in respect of whom the tax is payable by the employer), shall



obtain a certificate of enrolment from the assessing authority. The Tamil Nadu Tax on Professions, Trades, Callings and Employments Act, 1992, Andhra Pradesh Tax on Professions, Trades, Callings and Employments Act, 1987 and the Gujarat Panchayats, Municipalities, Municipal Corporations and State Tax on Professions, Traders, Callings and Employments Act, 1976 are applicable to the Company.

Central Goods and Services Tax Act, 2017

The Central Goods and Services Tax Act, 2017 (“**CGST Act**”) regulates the levy and collection of tax on the intra- State supply of goods and services by the Central Government or State Governments. The CGST Act amalgamates a large number of Central and State taxes into a single tax. The CGST Act mandates every supplier providing the goods or services to be registered within the State or Union Territory it falls under, within 30 days from the day on which he becomes liable for such registration. Such registrations can be amended, as well as cancelled by the proper office on receipt of application by the registered person or his legal heirs. There would be four tax rates namely 5%, 12%, 18% and 28%. The rates of GST applied are subject to variations based on the goods or services.

Under GST, SGST is a tax levied on Intra State supplies of both goods and services by the State Government and will be governed by the SGST Act. CGST will also be levied on the same Intra State supply but will be governed by the Central Government. The Tamil Nadu Goods and Services Tax Act, 2017, Rajasthan Goods and Services Tax Act, 2017, Andhra Pradesh Goods and Services Tax Act, 2017 and the Gujarat Goods and Services Tax Act, 2017 are applicable to the company.

Integrated Goods and Services Tax Act, 2017

Integrated Goods and Services Tax Act, 2017 (“**IGST Act**”) is a Central Act enacted to levy tax on the supply of any goods and/ or services in the course of inter-State trade or commerce. IGST is levied and collected by Centre on interstate supplies. The IGST Act sets out the rules for determination of the place of supply of goods. Where the supply involves movement of goods, the place of supply shall be the location of goods at the time at which the movement of goods terminates for delivery to the recipient. The IGST Act also provides for determination of place of supply of service where both supplier and recipient are located in India or where supplier or recipient is located outside India. The provisions relating to assessment, audit, valuation, time of supply, invoice, accounts, records, adjudication, appeal etc. given under the CGST Act are applicable to IGST Act.

C. ENVIRONMENTAL REGULATIONS

Our Company is also required to obtain clearances under the Environment (Protection) Act, 1986, and other environmental laws such as the Water (Prevention and Control of Pollution) Act, 1974, the Water (Prevention and Control of Pollution) Cess Act, 1977 and the Air (Prevention and Control of Pollution) Act, 1981, before commencing its operations. To obtain an environmental clearance, a no-objection certificate from the concerned state pollution control board must first be obtained, which is granted after a notified public hearing, submission and approval of an environmental impact assessment (“**EIA**”) report and an environment management plan (“**EMP**”).

Our Company must also comply at all times with the provisions of The Hazardous Waste (Management and Handling) Rules, 1989, as amended, and as superseded by the Hazardous Wastes (Management, Handling and Trans boundary Movement) Rules, 2008, and the Manufacture, Storage and Import of Hazardous Chemicals Rules, 1989.

Environment Protection Act, 1986 and Environment (Protection) Rules, 1986

The Environmental Protection Act, 1986 is an "umbrella" legislation designed to provide a framework for co-ordination of the activities of various central and state authorities established under various laws. The potential scope of the Act is broad, with "environment" defined to include water, air and land and the interrelationships which exist among water, air and land, and human beings and other living creatures, plants, micro-organisms and property.



Water

Legislations to control water pollution are listed below:

The *Water (Prevention and Control of Pollution) Act, 1974* prohibits the discharge of pollutants into water bodies beyond a given standard, and lays down penalties for non-compliance. The Water Act also provides that the consent of the State Pollution Control Board must be obtained prior to opening of any new outlets or discharges, which is likely to discharge sewage or effluent.

The *Water (Prevention and Control of Pollution) Cess Act, 1977* provides for the levy and collection of a cess on water consumed by persons carrying on certain industries and by local authorities, with a view to augment the resources of the Central Board and the State Boards for the prevention and control of water pollution constituted under the Water (Prevention and Control of Pollution) Act, 1974.

Air

Legislations to control air pollution are listed below:

The *Air (Prevention and Control of Pollution) Act, 1981* requires that any individual or institution responsible for emitting smoke or gases by way of use as fuel or chemical reactions must apply in a prescribed form and obtain consent from the state pollution control board prior to commencing any activity. National Ambient Air Quality Standards (NAAQS) for major pollutants were notified by the Central Pollution Control Board in April 1994.

Hazardous Wastes

There are several legislations that directly or indirectly deal with hazardous wastes. The relevant legislations are:

- The Hazardous Wastes (Management, Handling and Trans boundary Movement) Rules, 2008
- The Public Liability Insurance Act, 1991
- The Manufacture, Storage and Import of Hazardous Chemicals Rules, 1989.

Hazardous Wastes (Management, Handling and Trans boundary Movement) Rules, 2008

These rules require that the occupier and the operator of the facility, that treats hazardous wastes, must properly collect, treat, store or dispose the hazardous wastes without adverse effects on the environment. Schedule I of the said Rules lists out the primary and secondary production of aluminum as a process that generates hazardous waste and therefore requires compliance under these Rules.

D. OTHER REGULATIONS

Transfer of Property Act, 1882

The transfer of property, including immovable property, between living persons, as opposed to the transfer property by operation of law, is governed by the Transfer of Property Act, 1882 (“**T.P. Act.**”).The T.P. Act establishes the general principles relating to the transfer of property, including among other things, identifying the categories of property that are capable of being transferred, the persons competent to transfer property, the validity of restrictions and conditions imposed on the transfer and the creation of contingent and vested interest in the property. Transfer of property is subject to stamping and registration under the specific statutes enacted for the purposes which have been dealt with hereinafter.

The T.P. Act recognizes, among others, the following forms in which an interest in an immovable property may be transferred:

- Sale: The transfer of ownership in property for a price paid or promised to be paid.



- **Mortgage:** The transfer of an interest in property for the purpose of securing the payment of a loan, existing or future debt, or performance of an engagement which gives rise to a pecuniary liability. The T.P. Act recognises several forms of mortgages over a property.
- **Charges:** Transactions including the creation of security over property for payment of money to another which are not classifiable as a mortgage. Charges can be created either by operation of law, e.g. decree of the court attaching to specified immovable property, or by an act of the parties.
- **Leases:** The transfer of a right to enjoy property for consideration paid or rendered periodically or on specified occasions.
- **Leave and License:** The transfer of a right to do something upon immovable property without creating interest in the property.

Further, it may be noted that with regards to the transfer of any interest in a property, the transferor transfers such interest, including any incidents, in the property which he is capable of passing and under the law, he cannot transfer a better title than he himself possesses.

The Registration Act, 1908

The Registration Act, 1908 (“**Registration Act**”) was passed to consolidate the enactments relating to the registration of documents. The main purpose for which the Registration Act was designed was to ensure information about all deals concerning land so that correct land records could be maintained. The Registration Act is used for proper recording of transactions relating to other immovable property also. The Registration Act provides for registration of other documents also, which can give these documents more authenticity. Registering authorities have been provided in all the districts for this purpose.

The Indian Stamp Act, 1899

Stamp duty in relation to certain specified categories of instruments as specified under Entry 91 of the list, is governed by the provisions of the Indian Stamp Act, 1899 (“**Stamp Act**”) which is enacted by the Central Government. All other instruments are required to be stamped, as per the rates prescribed by the respective State Governments. Stamp duty is required to be paid on all the documents that are registered and as stated above the percentage of stamp duty payable varies from one state to another. Certain states in India have enacted their own legislation in relation to stamp duty while the other states have adopted and amended the Stamp Act, as per the rates applicable in the state. On such instruments stamp duty is payable at the rates specified in Schedule I of the Stamp Act.

Instruments chargeable to duty under the Stamp Act which are not duly stamped are incapable of being admitted in court as evidence of the transaction contained therein. The Stamp Act also provides for impounding of instruments which are not sufficiently stamped or not stamped at all. Unstamped and deficiently stamped instruments can be impounded by the authority and validated by payment of penalty. The amount of penalty payable on such instruments may vary from state to state. The Gujarat Stamp Act, 1958 is applicable to the Company.

The Indian Contract Act, 1872

The Indian Contract Act, 1872 (“**Contract Act**”) codifies the way in which a contract may be entered into, executed, implementation of the provisions of a contract and effects of breach of a contract. A person is free to contract on any terms he chooses. The Contract Act consists of limiting factors subject to which contract may be entered into, executed and the breach enforced. It provides a framework of rules and regulations that govern formation and performance of contract. The contracting parties themselves decide the rights and duties of parties and terms of agreement.

The Specific Relief Act, 1963

The Specific Relief Act, 1963 (“**Specific Relief Act**”) is complimentary to the provisions of the Contract Act and the Transfer of Property Act, as the Act applies both to movable property and immovable property. The Specific Relief Act applies in cases where the Court can order specific performance of a contract. Specific relief can be granted only for purpose of enforcing individual civil rights and not for the mere purpose of enforcing a civil law. ‘Specific performance’



means Court will order the party to perform his part of agreement, instead of imposing on him any monetary liability to pay damages to other party.

Consumer Protection Act, 1986

The Consumer Protection Act, 1986 seeks to provide better protection of interests of the consumers and for that purpose to make provision for establishment of consumer councils and other authorities for the settlement of consumer's disputes and for matters connected therewith. It seeks to promote and protect the rights of consumers.

To provide steady and simple redressal to consumers' disputes, a quasi-judicial machinery is sought to be set up at the district, state and central levels. The quasi-judicial bodies will observe the principles of natural justices and have been empowered to give relieves of a specific nature and to award wherever appropriate compensation to consumers. Penalties for non-compliance of the orders given by the quasi-judicial bodies have also been provided.

Competition Act, 2002

The Competition Act, 2002 ("**Competition Act**") aims to prevent anti-competitive practices that cause or are likely to cause an appreciable adverse effect on competition in the relevant market in India. The Competition Act regulates anti-competitive agreements, abuse of dominant position and combinations. The Competition Commission of India ("**Competition Commission**") which became operational from May 20, 2009 has been established under the Competition Act to deal with inquiries relating to anti-competitive agreements and abuse of dominant position and regulate combinations. The Competition Act also provides that the Competition Commission has the jurisdiction to inquire into and pass orders in relation to an anti-competitive agreement, abuse of dominant position or a combination, which even though entered into, arising or taking place outside India or signed between one or more non-Indian parties, but causes an appreciable adverse effect in the relevant market in India.

The Companies Act, 1956

The Companies Act, 1956 deals with laws relating to companies and certain other associations. It was enacted by the parliament in 1956. The Act primarily regulates the formation, financing, functioning and winding up of companies. The Companies Act, 1956 prescribes regulatory mechanism regarding all relevant aspects, including organizational, financial and managerial aspects of companies. It deals with issue, allotment and transfer of securities and various aspects relating to company management. It provides for standard of disclosure in public issues of capital, particularly in the fields of company management and projects, information about other listed companies under the same management, and management perception of risk factors. In the functioning of the corporate sector, although freedom of companies is important, protection of the investors and shareholders, on whose funds they flourish, is equally important. The Companies Act, 1956 plays the balancing role between these two competing factors, namely, management autonomy and investor protection.

The Companies Act, 2013

The Companies Act, 2013, has been introduced to replace the existing Companies Act, 1956 in a phased manner. The Ministry of Corporate Affairs has vide its notification dated September 12, 2013 has notified 98 Sections of the Companies Act, 2013 and the same are applicable from the date of the aforesaid notification. A further 183 Sections have been notified on March 26, 2014 and have become applicable from April 1, 2014. The Companies (Amendment) Act, 2015 has *inter-alia* amended various Sections of the Companies Act, 2013 to take effect from May 29, 2015. Further, vide the Companies (Amendment) Act, 2015, Section 11 of the Companies Act, 2013 has been omitted and Section 76A has been inserted in the Companies Act, 2013. As on date, till date, total 427 sections are notified by Ministry of Corporate Affairs. The Ministry of Corporate Affairs, has also issued rules complementary to the Companies Act, 2013 establishing the procedure to be followed by companies in order to comply with the substantive provisions of the Companies Act, 2013.



The Trademarks Act, 1999

Under the Trademarks Act, 1999 (“**Trademarks Act**”), a trademark is a mark capable of being represented graphically and which is capable of distinguishing the goods or services of one person from those of others used in relation to goods and services to indicate a connection in the course of trade between the goods and some person having the right as proprietor to use the mark. A ‘mark’ may consist of a device, brand, heading, label, ticket, name signature, word, letter, numeral, shape of goods, packaging or combination of colors or any combination thereof. Section 18 of the Trademarks Act requires that any person claiming to be the proprietor of a trade mark used or proposed to be used by him, must apply for registration in writing to the registrar of trademarks. The trademark, once applied for and which is accepted by the Registrar of Trademarks (“**the Registrar**”), is to be advertised in the trademarks journal by the Registrar. Oppositions, if any, are invited and, after satisfactory adjudications of the same, a certificate of registration is issued by the Registrar. The right to use the mark can be exercised either by the registered proprietor or a registered user. The present term of registration of a trademark is 10 (ten) years, which may be renewed for similar periods on payment of a prescribed renewal fee.

E. REGULATIONS REGARDING FOREIGN INVESTMENT

Foreign Investment

Foreign Exchange Management Act, 1999 (“the FEMA”)

Foreign investment in companies in the pharmaceutical sector is governed by the provisions of the Foreign Exchange Management Act, 1999 (“**FEMA**”) read with the applicable regulations. The Department of Industrial Policy and Promotion (“**DIPP**”), Ministry of Commerce and Industry has issued the Consolidated FDI Policy which consolidates the policy framework on Foreign Direct Investment (“**FDI Policy**”), with effect from August 28, 2017. The FDI Policy consolidates and subsumes all the press notes, press releases, and clarifications on FDI issued by DIPP till August 27, 2017. All the press notes, press releases, clarifications on FDI issued by DIPP till August 27, 2017 stand rescinded as on August 28, 2017.

In terms of the FDI Policy, Foreign investment is permitted (except in the prohibited sectors) in Indian companies either through the automatic route or the Government route, depending upon the sector in which foreign investment is sought to be made. In terms of the FDI Policy, the work of granting government approval for foreign investment under the FDI Policy and FEMA Regulations has now been entrusted to the concerned Administrative Ministries/Departments.

FDI for the items or activities that cannot be brought in under the automatic route may be brought in through the approval route. Where FDI is allowed on an automatic basis without the approval of the Government, the RBI would continue to be the primary agency for the purposes of monitoring and regulating Foreign Investment. In cases where Government approval is obtained, no approval of the RBI is required except with respect to fixing the issuance price, although a declaration in the prescribed form, detailing the foreign investment, must be filed with the RBI once the foreign investment is made in the Indian company.

The RBI, in exercise of its power under the FEMA, has also notified the Foreign Exchange Management (Transfer or Issue of Security by a Person Resident outside India) Regulations, 2017 to prohibit, restrict or regulate, transfer by or issue of security to a person resident outside India. The Company will also be required to make certain filings with the RBI after the completion of the Issue.



HISTORY AND CERTAIN CORPORATE MATTERS

Our Company manufactures and fabricates various steel products which are meant for its application in Pipe Support Systems, HVAC Systems, Anti-vibration System and Equipments for Industrial, Commercial, Utility and OEM Installations. We manufacture various engineering products, metal and base metal products like G. I. nuts, various types of bolts, clamps, hangers etc. Further our Product Portfolio includes all types of bathroom pipes, fittings, bathroom accessories and sanitary wares.

The following diagram depicts the breakup of revenue, percentage-wise for financial year ended March 31, 2018 on the basis of Manufacturing and Trading segments.

Revenue Model	
Manufacturing (61.22%) ⁽¹⁾	Trading (38.78%) ⁽¹⁾

⁽¹⁾Percentage (%) is calculated as a percentage of Total Sale of Products.

Certain products manufactured by us are certified by Underwriter's Laboratory Inc. (U.S.A) and FM Global Approved (U.S.A) which are meant to be used for Fire Sprinklers System Installations. Further, we are certified by Dun & Bradstreet which helps us in growing relationships through their global database and helps us in exploring the new potential customers.

We are certified by ISO 9001:2015 for manufacturing of various products i.e. UL and FM approved Pipe Hangers and Support Systems, Anti vibration products, Rubber support inserts, valves, S.S. Floor Drains. This certification confirms to the Quality Management System of our Company in relation to the manufacturing of various products.

Our Company has 3 manufacturing units located at Vasai. These manufacturing units are strategically located providing locational advantages. Our Company has installed various plant and machinery at our manufacturing facilities for manufacturing and fabrication of the varied products. For further details regarding machineries, please refer to "*Our Business - Plant and Machinery*" on page no. 108 of this Prospectus.

Our Company exports its products to various geographies such as USA and various countries in Middle East serving to various companies of several industries. We have a good customer base in India as well as internationally. These customers have been a part of the growth story of our Company which we believe is essentially due to the product quality and customer centric approach of our Company. We also have a good customer base in India for the products manufactured by us.

Our Company is even engaged in trading of textile products. We trade into fancy shirting and finish fabrics. Based on the orders received from our Customers for the textile products, we order the exact requirement from our suppliers and make the final product available to our Customers

For further details regarding our business operations, please see the chapter titled "*Our Business*" beginning on page no. 96 of this Prospectus.

Our Company has seven (7) shareholders, as on the date of this Prospectus.

MAJOR EVENTS

Financial Year	Milestones
2010	Incorporated under Companies Act, 1956 as Saketh Exim Private Limited
2011	Change in the management of our Company, wherein 'Patel Family' got majority control
2011	Purchase of Land admeasuring 300 sq. mtrs. on lease basis from MIDC
2014	Received UL Certification



Financial Year	Milestones
2016	Received ISO 9001:2015 certification confirming to the Quality Management System from the SGI
2016	Received FM Approvals
2016	Obtained a Certificate of Recognition as "One Star Export House" issued by the Additional Director General of Foreign Trade/ Development Commissioner (SEZ)
2017	Acquired Membership cum Registration with the Federation of Indian Export Organization
2017	Added further products to the product portfolio and widened the customer base
2017	Additional Machinery purchased for electroplating process i.e. we acquired a property on rent for set-up of the plant and machinery
2018	Changed the status of our Company from Private to Public i.e. to Saketh Exim Limited and adoption of new set of Memorandum & Articles of Association to bring in line with the Companies Act, 2013

MAIN OBJECTS

The main object of our Company is as follows:

- To carry on the business of exporters, importers, distributors, traders, manufacturers, valuers, patentees of hardwares, Machineries & other related engineering products and to act as contractor, sub-contractor in the fields of civil, mechanical & electrical engineering and to erect, construct, alter, repair, demolish and restore works of all description like wharves, docks, piers, railways, waterways, roads, bridges, warehouses, factories, mills, engines, machinery, boilers, railways locomotives, carriages and wagons, ships and vessels of every description, gas works, power station, water works, drainage and sewage works, and buildings and installations of every descriptions.
- To carry on the business as weavers or otherwise manufacturers, buyers, sellers, importers, exporters and dealers of silk, art silk, synthetic, woolen and cotton fabrics and other fibrous products including dressing and furnishing materials, uniforms, readymade garments, carpets and carpet backing, blankets padding knitted goods, woven bags, hosiery gloves, yarn and sewing thread and, To carry on the business of packing, grading, crimping, twisting, texturing, bleaching dyeing, printing, mercerizing or otherwise processing yarn, cloth, carpets, blankets and other textile goods, whether made from cotton, jute, wool, silk, art silk, synthetic and other fibers or blends thereof and also to carry on the business of manufacturing, buying, selling, importing, exporting and dealing in textiles, cotton, silk, art silk, rayon, nylon, synthetic fibers, staple fibers, polyester, worsted, wool, hemp and other fibre materials, yarn, cloth, linen, rayon and other goods or merchandise whether textile felted, netted or looped.

CHANGES IN REGISTERED OFFICE OF OUR COMPANY

Date of Change	Change of Registered Address		Reason for Change
	From	To	
September 29, 2017	143/4, Bhuva Cottage, 1 st Floor, Indulala Bhuva Road, Sewree, Wadala Road No. 9, Wadala, Mumbai - 400031	Plot No. PAP D-146/147, TTC MIDC, Turbhe, Navi Mumbai - 400705	Administrative Reasons

AMENDMENTS TO THE MEMORANDUM OF ASSOCIATION

Dates on which some of the main clauses of the Memorandum of Association of our Company have been changed citing the details of amendment as under:

Date	Nature of Amendment
July 06, 2011	The initial authorised share capital of ₹ 1,00,000 divided into 10,000 Equity Shares of ₹ 10 each was increased to ₹ 50,00,000 divided into 5,00,000 Equity Shares of ₹ 10 each.
March 02, 2015	Authorised Share Capital of our Company was increased from ₹ 50,00,000 divided into 5,00,000 equity shares of ₹ 10 each was increased to ₹ 2,00,00,000 divided into 20,00,000 equity shares of ₹ 10 each



Date	Nature of Amendment
September 29, 2017	Authorised Share Capital of our Company was increased from ₹ 2,00,00,000 divided into 20,00,000 equity shares of ₹ 10 each was increased to ₹ 3,50,00,000 divided into 35,00,000 equity shares of ₹ 10 each
December 07, 2017	The name of our Company was changed from “ <i>Saketh Exim Private Limited</i> ” to “ <i>Saketh Exim Limited</i> ” pursuant to fresh certificate of incorporation upon conversion dated December 19, 2017 issued by the Registrar of Companies, Maharashtra, Mumbai and Adoption of new Memorandum of Association to bring in line with the Companies Act, 2013
December 22, 2017	Inserting the following point in object clause as point 2 to Clause III (A): “ <i>To carry on the business as weavers or otherwise manufacturers, buyers, sellers, importers, exporters and dealers of silk, art silk, synthetic, woolen and cotton fabrics and other fibrous products including dressing and furnishing materials, uniforms, readymade garments, carpets and carpet backing, blankets padding knitted goods, woven bags, hosiery gloves, yarn and sewing thread and, To carry on the business of packing, grading, crimping, twisting, texturing, bleaching dyeing, printing, mercerizing or otherwise processing yarn, cloth, carpets, blankets and other textile goods, whether made from cotton, jute, wool, silk, art silk, synthetic and other fibers or blends thereof and also to carry on the business of manufacturing, buying, selling, importing, exporting and dealing in textiles, cotton, silk, art silk, rayon, nylon, synthetic fibers, staple fibers, polyester, worsted, wool, hemp and other fibre materials, yarn, cloth, linen, rayon and other goods or merchandise whether textile felted, netted or looped.</i> ”
March 18, 2018	Authorised Share Capital of our Company was increased from ₹ 3,50,00,000 divided into 35,00,000 equity shares of ₹ 10 each was increased to ₹ 5,50,00,000 divided into 55,00,000 equity shares of ₹ 10 each

SUBSIDIARY COMPANIES

As on the date of this Prospectus we do not have any subsidiary companies.

HOLDING COMPANY

As on the date of this Prospectus, our Company does not have any holding company within the meaning of Companies Act.

THE AMOUNT OF ACCUMULATED PROFIT / (LOSSES) NOT ACCOUNTED FOR BY OUR COMPANY

There is no accumulated profit/ (losses) not accounted for by our Company.

JOINT VENTURES

As on the date of this Prospectus, there are no joint ventures of our Company.

SHAREHOLDERS' AGREEMENT

There are no Shareholders' Agreements existing as on the date of this Prospectus.

ACQUISITION OF BUSINESS / UNDERTAKINGS

Our Company has not acquired any business or undertaken any mergers, amalgamation, revaluation of assets in the last five years.

FINANCIAL PARTNERS

We do not have any financial partners as on the date of this Prospectus.



STRATEGIC PARTNERS

We do not have any strategic partners as on the date of this Prospectus.

OTHER AGREEMENTS

Except the contracts / agreements entered in the ordinary course of the business carried on or intended to be carried on by our Company, we have not entered into any other agreement / contract as on the date of this Prospectus.

INJUNCTIONS OR RESTRAINING ORDERS

There are no injunctions / restraining orders that have been passed against the company.



OUR MANAGEMENT

Board of Directors:

Our Company has Five (5) Directors consisting of One (1) Executive Directors, Two (2) Non-Executive Non-Independent Director and Two (2) Non-Executive Independent Directors. The following table sets forth the details of our Board of Directors as on the date of this Prospectus:

Name, Current Designation, Address, Occupation, Term and DIN	Nationality	Age	Other Directorships
<p>Mr. Sanjay J Patel <i>Managing Director</i></p> <p>Address: 143/4, Bhuva Cottage, 1st Floor, Road No. 9, Indulal Bhuva Marg, Sewree Wadala, Mumbai - 400031</p> <p>Date of appointment as Director: January 21, 2011</p> <p>Date of appointment as Managing Director: December 20, 2017</p> <p>Term: Appointed as Managing Director for a period of five years from December 20, 2017</p> <p>Occupation: Service</p> <p>DIN: 01958033</p>	Indian	58 Years	<ul style="list-style-type: none"> • Tembo Exim Private Limited
<p>Mrs. Smita S Patel <i>Chairman and Non-Executive Non Independent Director</i></p> <p>Address: 143/4, Bhuva Cottage, 1st Floor, Road No. 9, Indulal Bhuva Marg, Sewree Wadala, Mumbai - 400031</p> <p>Date of appointment as Director: January 21, 2011</p> <p>Date of appointment as Non-Executive Non Independent Director: December 20, 2017</p> <p>Term: Liable to retire by rotation</p> <p>Occupation: Business</p> <p>DIN: 00348305</p>	Indian	57 Years	<ul style="list-style-type: none"> • Tembo Exim Private Limited
<p>Mrs. Taruna P Patel <i>Non-Executive Non Independent Director</i></p> <p>Address: Krishna Vihar 1st Floor, R No. 3-78, Rafi Ahmed Kidwai Road, Wadala, Mumbai -400031</p>	Indian	56 Years	<ul style="list-style-type: none"> ▪ Tembo Exim Private Limited



Name, Current Designation, Address, Occupation, Term and DIN	Nationality	Age	Other Directorships
Date of appointment as Director: January 21, 2011 Date of appointment as Non-Executive Non Independent Director: December 20, 2017 Term: Liable to retire by rotation Occupation: Business DIN: 00348453			
Mr. Jasbir Singh Anand <i>Non-Executive Independent Director</i> Address: Building No. B-10, Flat No.202, Avantika CHS, Kalpak Estate, Antop Hill, Mumbai - 400037 Date of Appointment as Non-Executive Independent Director: December 26, 2017 Term: For a term of five years until December 25, 2022 Occupation: Retired DIN: 08017248	Indian	68 Years	Nil
Mr. Jehan D Variava <i>Non-Executive Independent Director</i> Address: 1/1902, Flat No. 504, Patel Chambers, Chowki Street, Police Chowki, Nanpura, Surat M Corp, Surat, Gujarat – 395001 Date of Appointment as Non-Executive Independent Director: December 26, 2017 Term: For a term of five years until December 25, 2022 Occupation: Business DIN: 07825744	Indian	33 years	Nil

Further details on their qualification, experience etc., please see their respective biographies under the heading “*Brief Biographies*” below.

Notes:

- There are no arrangements or understanding with major shareholders, customers, suppliers or others, pursuant to which any of the Directors were selected as a Director.



- There is no service contracts entered into by the Directors with our Company providing for benefits upon termination of employment.
- None of the Directors is or was a director of any listed company during the last five years preceding the date of the Prospectus, whose shares have been or were suspended from being traded on the BSE or the NSE, during the term of their directorship in such company.
- None of the Directors is or was a director of any listed company which has been or was delisted from any recognized stock exchange in India during the term of their directorship in such company.
- None of the Directors is categorized as a willful defaulter, as defined under SEBI (ICDR) Regulations.

BRIEF BIOGRAPHIES OF OUR DIRECTORS

Mr. Sanjay J Patel

Mr. Sanjay J Patel, aged 58 years, is the Managing Director of our company. He holds Bachelor's degree in Commerce from University of Bombay. He has more than 3 decades of rich and vast experience in trading, wholesaling, exports and imports of engineering goods, pipes, fittings, ropes, stationery, fabrics, ball-pens, pencil and general items including experience with Chimanlal Enterprises and working as a freelancer on commission basis. Currently, he looks after day-to-day functioning of our Company and plays a pivotal role in handling trading division purchase, finance and taxation departments of the Company.

Mrs. Smita S Patel

Mrs. Smita S Patel, aged 57 years, is the Chairman and Non-Executive Non Independent Director of our Company. She holds Bachelor's degree in Science from Sardar Patel University. She has more than 10 years of experience in overlooking the general administration department.

Mrs. Taruna P Patel

Mrs. Taruna P Patel, aged 56 years, is the Non-Executive Non Independent Director of our Company. She holds Bachelor's degree in Commerce from Madhya Pradesh University. She has more than 10 years of experience in the field of human resource.

Mr. Jasbir Singh Anand

Mr. Jasbir Singh Anand, aged 68 years, is a Non-Executive Independent Director of our Company. He holds Bachelor's degree in Science from University of Bombay and has completed Second LLB (General). He is also an associate member of The Indian Institute of Bankers. He has over 36 years of experience of which around 34 years experience is from banking sector. He retired as Bank Manager of Punjab & Sind Bank in November 2009.

Mr. Jehan D Variava

Mr. Jehan D Variava, aged 33 years, is a Non-Executive Independent Director of our Company. He holds Bachelor's degree in Business Administration from Manipal University. He has also completed Advance Diploma in Business Administration from London Business Academy and Master's in International Business from University of Hertfordshire, UK. He has around 9 years of experience in Fashion & Apparel Industry. Recently he has started his own venture as Kianaa Fashion LLP which is engaged in the business of manufacturing and trading of traditional women wear.

RELATIONSHIP BETWEEN DIRECTORS

None of Directors on our Board are related to each other, except as mentioned below:

1. Mr. Sanjay J Patel and Mrs. Smita S Patel are related to each other as husband and wife;



2. Mrs. Taruna P Patel is related to Mr. Sanjay J Patel and Mrs. Smita S Patel as sister-in-law

Borrowing Powers of our Board of Directors

Our Company at its Extra-Ordinary General Meeting held on December 07, 2017 passed a resolution authorizing Board of Directors pursuant to the provisions of section 180(1)(c) of the Companies Act, 2013 for borrowing from time to time, any sum or sums of monies, which together with the monies already borrowed by the Company (apart from temporary loans obtained or to be obtained from the Company's bankers in the ordinary course of business), may exceed the aggregate of the paid-up capital of the Company and its free reserves, that is to say, reserves not set apart for any specific purpose, provided that the total outstanding amount so borrowed shall not at any time exceed the limit of ₹ 50 Crores.

REMUNERATION OF EXECUTIVE DIRECTORS

Mr. Sanjay J Patel, Managing Director

The Compensation package payable to him as resolved in the shareholders meeting held on December 22, 2017 is stated hereunder:

Basic Salary: ₹ 4.50 lakhs per month

Perquisites and Allowances:

- House Rent Allowance : ₹ 0.15 lakhs per month
- Petrol Allowance : ₹ 0.10 lakhs per month
- Medical Allowances : ₹ 0.15 lakhs per month
- Phone Allowances : ₹ 0.10 lakhs per month

Other Terms:

In the event of loss or inadequacy of profits in any financial year(s), during the currency of tenure of Mr. Sanjay J Patel as Managing Director of the Company, the above mentioned remuneration may be paid to Mr. Sanjay J Patel, as minimum remuneration, subject to the provisions prescribed under Section 197 read with Schedule V to the Companies Act, 2013 and rules framed there under and any other applicable provisions of the Act or any statutory modification or re-enactment thereof.

The Remuneration paid to Mr. Sanjay J Patel for FY 2017-18 was ₹ 47.00 lakhs.

Compensation of Non-Executive Non-Independent Director and Non-Executive Independent Directors

Pursuant to a resolution passed at the meeting of the Board of the Company on December 26, 2017 the Non-Executive Directors will be paid ₹ 2,000 per sitting fee for Board meeting and ₹ 2,000 per sitting fees for Committee meetings held.

Remuneration paid to our Non-Executive Independent Directors in FY 2017-18: ₹ 0.08 lakhs

Remuneration paid to our Non-Executive Non Independent Directors in FY 2017-18: ₹ 0.08 lakhs

Payment or benefit to Directors of Our Company

Except as disclosed in this Prospectus, no amount or benefit has been paid or given or is intended to be paid or given to any of our executive Directors except the normal remuneration for services rendered as a Director of our Company.

Shareholding of Directors

The following table sets forth the shareholding of our Directors as on the date of this Prospectus:



Name Of Directors	No. of Equity Shares held	% of Pre-Issue Paid Up Capital
Mr. Sanjay J Patel	6,25,875	16.05%
Mrs. Smita S Patel	4,44,375	11.39%
Mrs. Taruna P Patel	5,19,375	13.32%
Mr. Jasbir Singh Anand	-	-
Mr. Jehan D Variava	-	-
Total Holding of Directors	15,89,625	40.76%
Total Paid up Capital	39,00,000	100.00%

Interest of Directors

All of our Directors may be deemed to be interested to the extent of fees payable to them for attending meetings of the Board or a committee thereof as well as to the extent of other remuneration and reimbursement of expenses payable to them under our Articles of Association and to the extent of remuneration paid to them for services rendered as an officer or employee of our Company.

Our Directors may also be regarded as interested in the Equity Shares, if any, held by them or allotted to the companies in which they are interested as Directors, Members, and Promoters, pursuant to this issue. All of our Directors may also be deemed to be interested to the extent of any dividend payable to them and other distributions in respect of the said Equity Shares.

Except as stated in the chapters titled “*Our Management*”, “*Financial Indebtedness*” and the annexure titled “*Annexure XXV - Related Party Transactions*” beginning on page nos. 128, 188 and 169 of this Prospectus respectively, our Directors do not have any other interest in our business.

Except as disclosed in “*Properties*” within the chapter titled “*Our Business*” on page no. 112 of this Prospectus, our Directors have no interest in any property acquired by our Company within two years of the date of this Prospectus. Further, except as disclosed in “*Properties*” within the chapter titled “*Our Business*” on page no. 112 of this Prospectus, our Company has not taken any property on lease from our Promoters within two years of the date of this Prospectus.

Changes in our Board of Directors in the last three years

Following are the changes in our Board of Directors in the last three years:

Name	Date of Change	Reason
Mr. Sanjay J Patel	December 20, 2017	Change in designation as Managing Director
Mrs. Smita S Patel	December 20, 2017	Change in designation as Chairman & Non Executive Non Independent Director
Mrs. Taruna P Patel	December 20, 2017	Change in designation as Non Executive Non Independent Director
Mr. Jasbir Singh Anand	December 26, 2017	Appointment as Additional Non Executive Independent Director
Mr. Jehan D Variava	December 26, 2017	Appointment as Additional Non Executive Independent Director
Mr. Jasbir Singh Anand	July 18, 2018	Regularisation as Non Executive Independent Director
Mr. Jehan D Variava	July 18, 2018	Regularisation as Non Executive Independent Director

Corporate Governance

In addition to the applicable provisions of the Companies Act, 2013 with respect to corporate governance, provisions of the SEBI Listing Regulations to the extent applicable to the entity whose shares are listed on the SME Exchange will also be applicable to us immediately upon the listing of our Equity Shares with the Stock Exchange. We are in compliance with the requirements of the applicable regulations, including the SEBI Listing Regulations, the SEBI Regulations and the Companies Act, in respect of corporate governance including constitution of the Board and committees thereof.



Our Board has been constituted in compliance with the Companies Act and SEBI (LODR) Regulations, 2015. The Board functions either as a full board or through various committees constituted to oversee specific functions. Our executive management provides our Board detailed reports on its performance periodically.

Currently, our Board has Five (5) Directors. In compliance with the requirements of the Companies Act we have One (1) Executive Director, Two (2) Non Executive Non-Independent Directors and Two (2) Non Executive Independent Directors on our Board. Our Chairman is a Non-Executive Director and we have 2 (Two) woman director on our Board.

Committees of our Board

We have constituted the following committees of our Board of Directors for compliance with corporate governance requirements:

1. Audit Committee
2. Stakeholder's Relationship Committee
3. Nomination and Remuneration Committee

1. Audit Committee

The Audit Committee of our Board was re-constituted by our Directors by a board resolution dated December 26, 2017 pursuant to section 177 of the Companies Act, 2013. The Audit Committee comprises of:

Sr. No.	Name	Designation in Committee	Nature of Directorship
1.	Mr. Jasbir Singh Anand	Chairman	Non-executive Independent Director
2.	Mr. Jehan D Variava	Member	Non-executive Independent Director
3.	Mr. Sanjay J Patel	Member	Managing Director

The scope of Audit Committee shall include but shall not be restricted to the following:

- a. Oversight of the Issuer's financial reporting process and the disclosure of its financial information to ensure that the financial statement is correct, sufficient and credible;
- b. Recommending to the Board, the appointment, re-appointment and, if required, the replacement or removal of the statutory auditor and the fixation of audit fees;
- c. Approval of payment to statutory auditors for any other services rendered by the statutory auditors;
- d. Reviewing, with the management, the annual financial statements before submission to the board for approval, with particular reference to:
 - Matters required to be included in the Director's Responsibility Statement to be included in the Board's report in terms of clause (c) of sub-section 3 of Section 134 of the Companies Act, 2013
 - Changes, if any, in accounting policies and practices and reasons for the same
 - Major accounting entries involving estimates based on the exercise of judgment by management
 - Significant adjustments made in the financial statements arising out of audit findings
 - Compliance with listing and other legal requirements relating to financial statements
 - Disclosure of any related party transactions
 - Qualifications in the draft audit report
- e. Reviewing, with the management, the half yearly financial statements before submission to the board for approval;



- f. Reviewing, with the management, the statement of uses / application of funds raised through an issue (public issue, rights issue, preferential issue, etc.), the statement of funds utilized for purposes other than those stated in the Offer Document /notice and the report submitted by the monitoring agency monitoring the utilization of proceeds of a public or rights issue, and making appropriate recommendations to the Board to take up steps in this matter;
- g. Review and monitor the auditor's independence and performance, and effectiveness of audit process;
- h. Approval or any subsequent modification of transactions of the company with related parties;
- i. Scrutiny of inter-corporate loans and investments;
- j. Valuation of undertakings or assets of the company, wherever it is necessary;
- k. Evaluation of internal financial controls and risk management systems;
- l. Reviewing, with the management, performance of statutory and internal auditors, adequacy of the internal control systems;
- m. Reviewing the adequacy of internal audit function, if any, including the structure of the internal audit department, staffing and seniority of the official heading the department, reporting structure coverage and frequency of internal audit;
- n. Discussion with internal auditors any significant findings and follow up there on;
- o. Reviewing the findings of any internal investigations by the internal auditors into matters where there is suspected fraud or irregularity or a failure of internal control systems of a material nature and reporting the matter to the board;
- p. Discussion with statutory auditors before the audit commences, about the nature and scope of audit as well as post-audit discussion to ascertain any area of concern;
- q. To look into the reasons for substantial defaults in the payment to the depositors, debenture holders, shareholders (in case of non-payment of declared dividends) and creditors;
- r. To review the functioning of the Whistle Blower mechanism;
- s. Approval of appointment of CFO (i.e., the whole-time Finance Director or any other person heading the finance function or discharging that function) after assessing the qualifications, experience & background, etc. of the candidate;
- t. Carrying out any other function as is mentioned in the terms of reference of the Audit Committee.

Explanation (i): The term "related party transactions" shall have the same meaning as contained in the Accounting Standard 18, Related Party Transactions, issued by The Institute of Chartered Accountants of India.

Explanation (ii): If the Issuer has set up an audit committee pursuant to provision of the Companies Act, the said audit committee shall have such additional functions / features as is contained in this clause.

The Audit Committee enjoys following powers:

- 1. To investigate any activity within its terms of reference;
- 2. To seek information from any employee;



3. To obtain outside legal or other professional advice;
4. To secure attendance of outsiders with relevant expertise if it considers necessary;
5. The audit committee may invite such of the executives, as it considers appropriate (and particularly the head of the finance function) to be present at the meetings of the committee, but on occasions it may also meet without the presence of any executives of the Issuer. The finance director, head of internal audit and a representative of the statutory auditor may be present as invitees for the meetings of the audit committee.

The Audit Committee shall mandatorily review the following information:

- a. Management discussion and analysis of financial condition and results of operations;
- b. Statement of significant related party transactions (as defined by the audit committee), submitted by management;
- c. Management letters / letters of internal control weaknesses issued by the statutory auditors;
- d. Internal audit reports relating to internal control weaknesses; and
- e. The appointment, removal and terms of remuneration of the Chief internal auditor shall be subject to review by the Audit Committee.

The recommendations of the Audit Committee on any matter relating to financial management, including the audit report, are binding on the Board. If the Board is not in agreement with the recommendations of the Committee, reasons for disagreement shall have to be incorporated in the minutes of the Board Meeting and the same has to be communicated to the shareholders. The Chairman of the committee has to attend the Annual General Meetings of the Company to provide clarifications on matters relating to the audit.

The Company Secretary of the Company acts as the Secretary to the Committee.

Meeting of Audit Committee

The audit committee shall meet at least four times in a year and not more than one hundred and twenty days shall elapse between two meetings. The quorum shall be either two members or one third of the members of the audit committee whichever is greater, but there shall be a minimum of two independent members present. Since the formation of the committee, no Audit Committee meetings have taken place.

2. Stakeholder's Relationship Committee

The Shareholder and Investor Grievance Committee of our Board were constituted by our Directors pursuant to section 178 (5) of the Companies Act, 2013 by a board resolution dated December 26, 2017. The Shareholder and Investor Grievance Committee comprises of:

Sr. No.	Name	Designation in Committee	Nature of Directorship
1.	Mrs. Smita S Patel	Chairman	Non-executive Non-Independent Director
2.	Mr. Sanjay J Patel	Member	Managing Director
3.	Mrs. Taruna P Patel	Member	Non-executive Non-Independent Director

This committee will address all grievances of Shareholders/Investors and its terms of reference include the following:

- a. Allotment and listing of our shares in future;



- b. Redressing of shareholders and investor complaints such as non-receipt of declared dividend, annual report, transfer of Equity Shares and issue of duplicate/split/consolidated share certificates;
- c. Monitoring transfers, transmissions, dematerialization, re-materialization, splitting and consolidation of Equity Shares and other securities issued by our Company, including review of cases for refusal of transfer/ transmission of shares and debentures;
- d. Reference to statutory and regulatory authorities regarding investor grievances;
- e. To otherwise ensure proper and timely attendance and redressal of investor queries and grievances;
- f. And to do all such acts, things or deeds as may be necessary or incidental to the exercise of the above powers.

The Company Secretary of our Company acts as the Secretary to the Committee.

Quorum and Meetings

The quorum necessary for a meeting of the Stakeholders Relationship Committee shall be two members or one third of the members, whichever is greater. Since the formation of the committee, no Stakeholders Relationship Committee meetings have taken place.

3. Nomination and Remuneration Committee

The Nomination and Remuneration Committee of our Board was constituted by our Directors pursuant to section 178 of the Companies Act, 2013 by a board resolution dated December 26, 2017.

The Nomination and Remuneration Committee currently comprises of:

Sr. No.	Name	Designation in Committee	Nature of Directorship
1.	Mr. Jehan D Variava	Chairman	Non-executive Independent Director
2.	Mr. Jasbir Singh Anand	Member	Non-executive Independent Director
3.	Mrs. Smita S Patel	Member	Non-executive Director

The scope of Nomination and Remuneration Committee shall include but shall not be restricted to the following:

- a. Formulation of the criteria for determining qualifications, positive attributes and independence of a director and recommend to the Board a policy, relating to the remuneration of the directors, key managerial personnel and other employees;
- b. Formulation of criteria for evaluation of Independent Directors and the Board;
- c. Devising a policy on Board diversity;
- d. Identifying persons who are qualified to become directors and who may be appointed in senior management in accordance with the criteria laid down, and recommend to the Board their appointment and removal. The company shall disclose the remuneration policy and the evaluation criteria in its Annual Report.

Quorum and Meetings

The quorum necessary for a meeting of the Nomination and Remuneration Committee shall be two members or one third of the members, whichever is greater. The Committee is required to meet at least once a year.

The Company Secretary of our Company acts as the Secretary to the Committee.



Policy on Disclosure and Internal Procedure for Prevention of Insider Trading

The provisions of Regulation 8 and 9 of the SEBI (Prohibition of Insider Trading) Regulations, 2015 will be applicable to our Company immediately upon the listing of its Equity Shares on the Stock Exchange. We shall comply with the requirements of the SEBI (Prohibition of Insider Trading) Regulations, 2015 on listing of our Equity Shares on stock exchange. Further, Board of Directors have approved and adopted the policy on insider trading in view of the proposed Public Offer.

Our Board is responsible for setting forth policies, procedures, monitoring and adherence to the rules for the preservation of price sensitive information and the implementation of the code of conduct under the overall supervision of the board.



Management Organization Structure

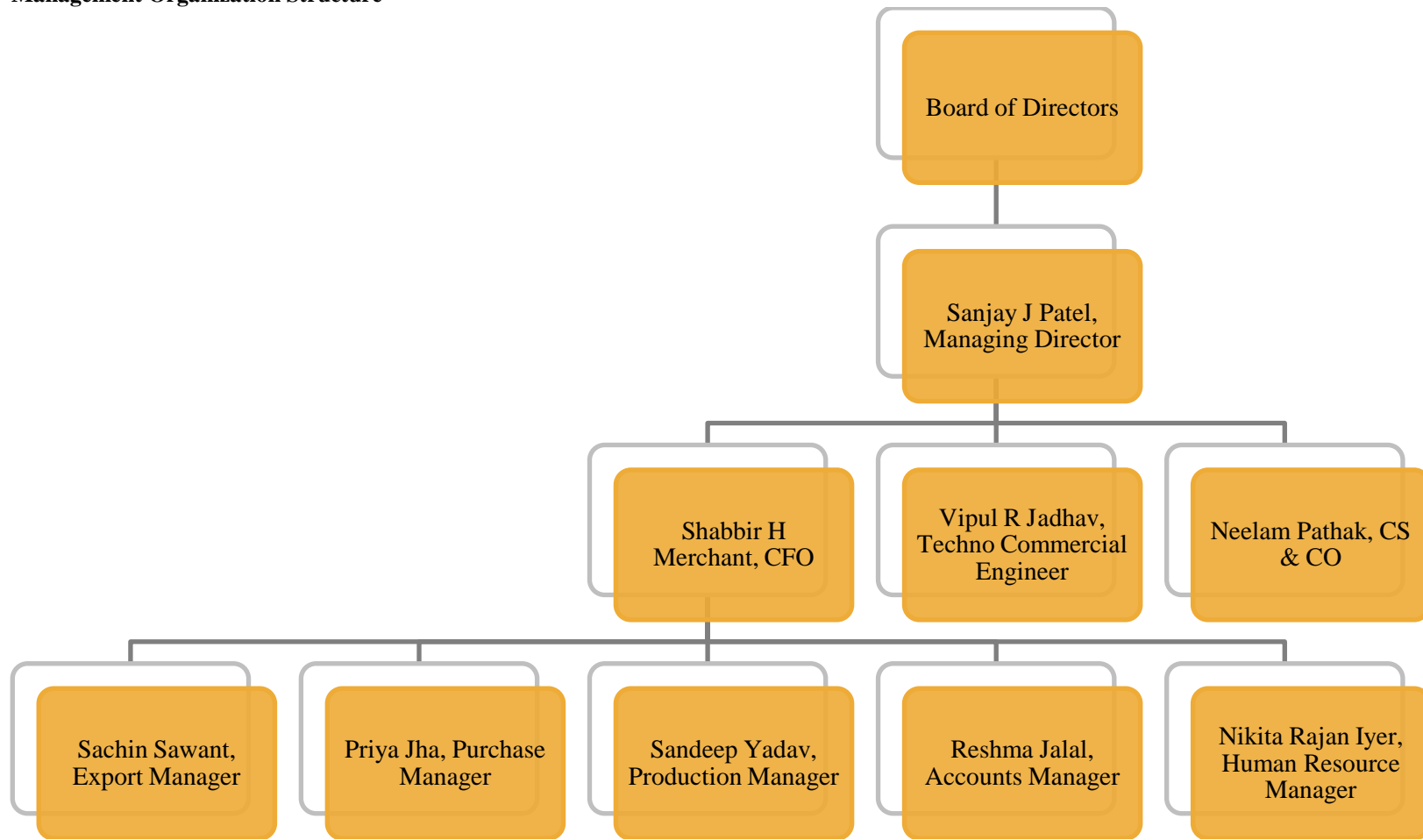

CFO - Chief Financial Officer
CS and CO - Company Secretary and Compliance Officer



Key Managerial Personnel

The following table sets forth the Key Managerial Personnel and their significant details:

Name of Employee	Current Designation and Functional Area	Date of Original Appointment	Compensation for Last Fiscal Year (₹ in lakhs)	Qualification	Name of Previous Employer	Total Years of Experience (Approx.)
Mr. Sanjay J Patel	MD	January 21, 2011 ⁽¹⁾	47.00	Bachelor of Commerce	<ul style="list-style-type: none"> Chimanlal Enterprise Tembo Exim Private Limited 	36 Years
Mr. Shabbir H Merchant	CFO	December 20, 2017	1.44 ⁽²⁾	<ul style="list-style-type: none"> Bachelor of Law Bachelor of Commerce Master of Business Administration 	<ul style="list-style-type: none"> BM Electro Mechanical LLP EBBA Engineering Private Limited Galadari Investments HDFC Bank Limited ICICI Bank Limited 	17 Years
Mr. Vipul R Jadhav	Techno Commercial Engineer	July 21, 2015	3.09	Bachelor of Engineering (Mechanical)	Nil	3 Years
Mrs. Reshma Jalal	Accounts Manager	December 15, 2016	3.29	<ul style="list-style-type: none"> Master of Commerce 	<ul style="list-style-type: none"> Karnala Nagari Sahakari Bank Shree Ram Enterprises Fortune Cars Private Limited Kamal Motors V-Ensure Pharma Technologies Private Limited 	16 Years
Mr. Sachin A Sawant	Export Manager	April 01, 2017	2.40	Bachelor of Commerce	<ul style="list-style-type: none"> Tembo Exim Private Limited 	11 Years
Mr. Sandeep S Yadav	Production Manager	April 06, 2017	2.40	Bachelor of Engineering (Mechanical)	<ul style="list-style-type: none"> BM Electromechanical LLP Gandhi Automations Private Limited Bombay Amusement Rides Private Limited 	10 Years



Name of Employee	Current Designation and Functional Area	Date of Original Appointment	Compensation for Last Fiscal Year (₹ in lakhs)	Qualification	Name of Previous Employer	Total Years of Experience (Approx.)
					<ul style="list-style-type: none">The Freyssinet Prestressed Concrete Company LimitedNikhil Comforts	
Ms. Nikita Rajan Iyer	Human Resource Executive	November 16, 2017	0.67 ⁽²⁾	<ul style="list-style-type: none">Master of Management StudiesBachelor of Commerce	<ul style="list-style-type: none">PC Technology Private LimitedDenfab Consulting Engineers Private LimitedOil and Natural Gas Corporation	2 Years (including Internship)
Ms. Priya B Jha	Purchase Manager	April 01, 2017	2.57	Bachelor of Commerce	<ul style="list-style-type: none">Tembo Exim Private Limited	3 Years
Ms. Neelam Pathak	CS & CO	April 04, 2018	Nil ⁽²⁾	Associate Member of ICSI	<ul style="list-style-type: none">Saketh Exim LimitedABNJ & Co.M. P. Sharma & CompanyCouple Finevest Private LimitedJayesh Shah & Co., Chartered Accountant	2 Years (including 15 months CS Training)

⁽¹⁾ Mr. Sanjay J Patel was promoted at various intervals since January 21, 2011 and on December 20, 2017 was appointed as Managing Director of our Company.

⁽²⁾ Appointed during the financial year 2017-18 and 2018-19, hence compensation for full fiscal year not available.

Other Notes:

The aforementioned KMPs are on the payrolls of our Company as permanent employees.



Relationship amongst the Key Managerial Personnel

None of the KMP's of our Company is related to each other as on the date of this Prospectus.

Except Mr. Shabbir H Merchant, husband of Mrs. Fatema S Kachwala (Promoter), none of the KMP has been selected pursuant to any formal arrangement/understanding with major shareholders/ customers/ suppliers.

Shareholding of Key Managerial Personnel

None of our KMP's holds any shares of our Company as on the date of this Prospectus except for Mr. Sanjay J Patel, who holds 6,25,875 Equity Shares of our Company.

Interest of Key Managerial Personnel

The Key Managerial Personnel of our Company do not have any interest in our Company, other than to the extent of remuneration of benefits to which they are entitled as per their terms of appointment and reimbursement of expenses incurred by them during the ordinary course of business. Further, if any Equity Shares are allotted to our Key Managerial Personnel prior to/ in terms of this Issue, they will be deemed to be interested to the extent of their shareholding and / or dividends paid or payable on the same.

Bonus or Profit Sharing Plan for the Key Managerial Personnel

Our Company does not have fixed bonus/profit sharing plan for any of the employees, key managerial personnel.

Loans taken by Key Management Personnel

Except for loan of ₹ 0.18 lakhs to Mr. Vipul R Jadhav, none of our Key Managerial Personnel have taken any loan from our Company as on the year ended March 31, 2018.

Employee Share Purchase and Employee Stock Option Scheme

Presently, we do not have ESOP/ESPS scheme for employees.

Payment or Benefit to our Officers

Except for the payment of salaries and yearly bonus, we do not provide any other benefits to our employees.

Changes in the Key Managerial Personnel in the three years preceding the date of filing this Prospectus

Name	Designation	Date of Joining/ Change in Designation
Mr. Sanjay J Patel	December 20, 2017	Change in designation as Managing Director
Mr. Shabbir H Merchant	December 20, 2017	Appointment as CFO
Mr. Sachin A Sawant	April 01, 2017	Appointment as Export Manager
Mr. Sandeep S Yadav	April 06, 2017	Appointment as Production Manager
Mrs. Pallavi Deb	July 18, 2016	Appointment as Human Resource Manager
Ms. Priya B Jha	April 01, 2017	Appointment as Purchase Manager
Ms. Reshma Jalal	December 15, 2016	Appointment as Accounts Manager
Mr. Ramichand Rajput	December 20, 2017	Appointment of CS & Compliance Officer
Mrs. Pallavi Deb	April 24, 2018	Resignation
Ms. Nikita Rajan	November 16, 2017	Appointment of Human Resource Executive
Mr. Ramichand Rajput	April 03, 2018	Resignation
Ms. Neelam Pathak	April 04, 2018	Appointment of CS & Compliance Officer





OUR PROMOTERS AND PROMOTER GROUP

THE PROMOTERS OF OUR COMPANY ARE:

1. Mr. Sanjay J Patel (Individual Promoter)
2. Mrs. Smita S Patel (Individual Promoter)
3. Mrs. Taruna P Patel (Individual Promoter)
4. Mrs. Fatema S Kachwala (Individual Promoter)

The details of our Individual Promoter are provided below:

Mr. Sanjay J Patel		
	PAN	AAJPP2657H
	Passport Number	L4799527
	Driving License	NA
	Voter's ID	ZHS1674324
	Bank & Branch	Bank of India, Narsi Natha St, Mumbai
	Bank A/c No.	003210110004189
	Other Interests	Tembo Exim Private Limited

Mrs. Smita S Patel		
	PAN	AAHPP7398D
	Passport Number	L6120104
	Driving License	NA
	Voter's ID	ZHS1674332
	Bank & Branch	Bank of India, Maheshwari Udhyan, Mumbai
	Bank A/c No.	002910110001669
	Other Interests	Tembo Exim Private Limited

Mrs. Taruna P Patel		
	PAN	AAKPP5321P
	Passport Number	L 5261884
	Driving License	NA
	Voter's ID	ZHS4866919
	Bank & Branch	Bank of India, Maheshwari Udhyan, Mumbai
	Bank A/c No.	002910110001667
	Other Interests	Tembo Exim Private Limited

Mrs. Fatema S Kachwala		
	Mrs. Fatema S Kachwala, aged 35 years, is the Promoter of our Company. She holds Master's degree in Commerce from University of Pune and also holds Post Graduate Diploma in International Business. She has around 9 years experience including experience in the field of human resource. She is also designated partner of B.M.Electro Mechanical LLP.	
	PAN	AQUPK4999C
	Passport Number	Z4634918
	Driving License	NA
	Voter's ID	NA
	Bank & Branch	ICICI Bank, Andheri West Branch
	Bank A/c No.	041201503188
	Other Interests	B.M.Electro Mechanical LLP

For additional details on the age, background, personal address, educational qualifications, experience, positions / posts and other Directorships held in the past for our Individual Promoter, please see the chapter titled "Our Management" beginning on page no. 128 of this Prospectus.



For details of the build-up of our Promoters' shareholding in our Company, please see "Capital Structure –Notes to Capital Structure" on page no. 61 of this Prospectus.

Other Undertakings and Confirmations

We confirm that the Permanent Account Number, Bank Account number and Passport number of our Promoters have been submitted to the Stock Exchange at the time of filing of the Draft Prospectus with the Stock Exchange.

Our Promoters have confirmed that they have not been identified as wilful defaulters.

No violations of securities laws have been committed by our Promoters in the past or are currently pending against them. None of our Promoters are debarred or prohibited from accessing the capital markets or restrained from buying, selling, or dealing in securities under any order or directions passed for any reasons by the SEBI or any other authority or refused listing of any of the securities issued by any such entity by any stock exchange in India or abroad.

Interests of Promoters

None of our Promoters / Directors have any interest in our Company except to the extent of compensation payable / paid, rents on properties owned by their relatives but used by our company and reimbursement of expenses (if applicable) and to the extent of any equity shares held by them or their relatives and associates or held by the companies, firms and trusts in which they are interested as director, member, partner, and / or trustee, and to the extent of benefits arising out of such shareholding. For further details please see the chapters titled "Capital Structure", "Financial Information" and "Our Management" beginning on page nos. 60, 151 and 128 of this Prospectus.

Except as stated otherwise in this Prospectus, we have not entered into any contract, agreements or arrangements in which our Promoters are directly or indirectly interested and no payments have been made to them in respect of the contracts, agreements or arrangements which are proposed to be made with them including the properties purchased by our Company other than in the normal course of business.

Common Pursuits of our Group Companies

Save and except as disclosed in the chapter titled "Our Group Companies" beginning on page no. 146 of this Prospectus, there are no Group Companies of our Promoters to undertake activities which are similar to ours and are currently engaged in businesses similar to ours.

Companies with which the Promoters has disassociated in the last three years

Our Promoters have not disassociated themselves from any companies, firms or entities during the last three years preceding the date of this Prospectus.

Payment of Amounts or Benefits to the Promoters or Promoters Group during the last two years

Except as stated in "Annexure XXV – Statement of Related Party Transactions" on page no. 169 of this Prospectus, there has been no payment of benefits to our Promoters during the two years preceding the date of the Prospectus.

Interest of Promoters in the Promotion of our Company

Our Company is currently promoted by the Promoters in order to carry on its present business. Our Promoters are interested in our Company to the extent of their shareholding and directorship in our Company and the dividend declared, if any, by our Company.

Interest of Promoters in the Property of our Company

Our Promoters have confirmed that they do not have any interest in any property acquired by our Company within two years preceding the date of this Prospectus or proposed to be acquired by our Company as on the date of this Prospectus. For details, please the chapter "Our Business" on page no. 96 of this Prospectus.

Further, other than as mentioned in the chapter titled "Our Business", our Promoters do not have any interest in any transactions in the acquisition of land, construction of any building or supply of any machinery.



Our Promoters may be interested in rent being paid by our company to certain relatives who own these premises being occupied by the company. For further details please see “*Our Business*” and “*Financial Information*” beginning on page nos. 96 and 151 of this Prospectus.

Interest of Promoters in our Company other than as Promoter

Other than as Promoters, our Promoters are interested in our Company to the extent of their shareholding and directorship in our Company and the dividend declared, if any, by our Company. For details please see chapters titled “*Our Management*” and “*Capital Structure*” beginning on page nos. 128 and 60 respectively of this Prospectus.

Except as mentioned in this section and the chapters titled “*Capital Structure*”, “*Our Business*”, “*History and Certain Corporate matters*” and “*Annexure XXV – Statement of Related Party Transactions*” on page nos. 60, 96, 124 and 169 of this Prospectus, respectively, our Promoters do not have any interest in our Company other than as Promoters.

Related Party Transactions

Except as stated in the “*Annexure XXV – Statement of Related Party Transactions*” on page no. 169 of this Prospectus, our Company has not entered into related party transactions with our Promoters or our Group Companies.

Shareholding of the Promoter Group in our Company

For details of shareholding of members of our Promoters Group as on the date of this Prospectus, please see the chapter titled “*Capital Structure – Notes to Capital Structure*” beginning on page no. 61 of this Prospectus.

Other Confirmations

Our Company has neither made any payments in cash or otherwise to our Promoters or to firms or companies in which our Promoters are interested as members, directors or Promoters nor have our Promoters been offered any inducements to become directors or otherwise to become interested in any firm or company, in connection with the promotion or formation of our Company otherwise than as stated in the “*Annexure XXV – Statement of Related Party Transactions*” on page no. 169 of this Prospectus.

Outstanding Litigation

There is no outstanding litigation against our Promoters except as disclosed in the section titled “*Risk Factors*” and chapter titled “*Outstanding Litigation and Material Developments*” beginning on page nos. 15 and 191 of this Prospectus.

OUR PROMOTER GROUP

In addition to the Promoter named above, the following natural persons and entities form part of our Promoter Group in terms of Regulation 2 (1) (zb) (ii) of the SEBI (ICDR) Regulation, 2009.

A. Natural Persons who are Part of the Promoter Group

Name of the Promoters	Name of the Relative	Relationship with the Promoter
Mr. Sanjay J Patel	Mr. Jashbhai C Patel	Father
	Mrs. Urmilaben J Patel	Mother
	Mrs. Smita S Patel	Spouse
	Mr. Piyush J. Patel	Brother(s)
	-	Sister(s)
	Ms. Saloni S Patel	Daughter(s)
	Master Shalin S Patel	Son(s)
	Mr. Jayantibhai Patel	Wife's Father
	Mrs. Sharaben J Patel	Wife's Mother
	-	Wife's Brother(s)
	Mrs. Kalpana A Patel	Wife's Sister(s)



Name of the Promoters	Name of the Relative	Relationship with the Promoter
Mrs. Smita S Patel	Mr. Jayantibhai Patel	Father
	Mrs. Sharaben J Patel	Mother
	Mr. Sanjay J Patel	Spouse
	-	Brother(s)
	Mrs. Kalpana A Patel	Sister(s)
	Ms. Saloni S Patel	Daughter(s)
	Master Shalin S Patel	Son(s)
	Mr. Jashbhai C Patel	Husband's Father
	Mrs. Urmilaben J Patel	Husband's Mother
	Mr. Piyush J Patel	Husband's Brother(s)
-	Husband's Sister	

Name of the Promoters	Name of the Relative	Relationship with the Promoter
Mrs. Taruna P Patel	Mr. Ramanbhai Patel	Father
	Mrs. Kamlaben R Patel	Mother
	Mr. Piyush J Patel	Spouse
	Mr. Bhupender R Patel	Brother(s)
	Mrs. Reeta Y Patel	Sister(s)
	Master Rushil P. Patel	Son(s)
	Mrs. Priyanka M Geelani	Daughter(s)
	Mr. Jashbhai C Patel	Husband's Father
	Mrs. Urmilaben J Patel	Husband's Mother
	Mr. Sanjay J Patel	Husband's Brother
-	Husband's Sister	

Name of the Promoters	Name of the Relative	Relationship with the Promoter
Mrs. Fatema S Kachwala	Mr. Shabbir Kachwala	Father
	Mrs. Armin Kachwala	Mother
	Mr. Shabbir Merchant	Spouse
	Mr. Ali Kachwala	Brother(s)
	-	Sister(s)
	-	Son(s)
	Ms. Batul Merchant	Daughter(s)
	Mr. Huseini Merchant	Husband's Father
	Mrs. Sakina Merchant	Husband's Mother
	-	Husband's Brother
Mrs. Umaima Haji	Husband's Sister	

B. Companies / Corporate Entities forming part of the Promoter Group

As per Regulation 2(1)(zb)(iv) and 2(1)(zb)(v) of the SEBI (ICDR) Regulations, 2009, the following Companies / Trusts / Partnership firms / HUFs or Sole Proprietorships shall form part of our Promoter Group:

Sr. No.	Name of Promoter Group Entity/Company
1.	Tembo Exim Private Limited
2.	B.M.Electro Mechanical LLP
3.	Raj Electroplating



OUR GROUP COMPANY

In accordance with the provisions of SEBI (ICDR) Regulations, for the purpose of identification of Group Companies, our Company has considered companies as covered under the applicable Accounting Standards, being Accounting Standard 18 issued by the Institute of Chartered Accountants of India (“AS 18”) as per the Restated Financial Statements and other companies as per the policy adopted by our Board. Our Board of Directors have considered a company as Group Company if (i) such company forms part of the Promoter Group and (ii) our Company has entered into one or more transactions with such company in the previous audited Fiscal (in respect of which, the financial statements to be included in the Offer Document) which, cumulatively exceeds 1% of the revenue of our Company of such audited Fiscal. Based on the above, only Tembo Exim Private Limited (“TEPL”) is forming part of our Group Company.

Further, our Board has approved that other than TEPL, there are no companies which are considered material by the Board to be identified as a group company.

DETAILS OF OUR GROUP COMPANY:

TEMBO EXIM PRIVATE LIMITED (“TEPL”)

Corporate Information:

Incorporation	TEPL was incorporated on February 21, 2006 as ‘Dutron Pipes & Hoses Private Limited’ under the Companies Act, 1956 by the Assistant Registrar of Companies. Subsequently on April 13, 2011 the name of the Company was changed to ‘Tembo Exim Private Limited’ vide Fresh Certificate of Incorporation Consequent on Change of Name.
CIN	U25191MH2006PTC159913
Registered Office	143-4, Bhuva Cottage, 1 st Floor, Indulal Bhuva Marg, Wadala West, City Greater Mumbai, Wadala, Mumbai - 400031
Registrar of Companies	100, Everest, Marine Drive Mumbai- 400002
Nature of Business	Engaged in the business of trading of fabric and textile related products and deals in all varieties, characteristics, of pipes, plastic materials, rubber materials, rigid and flexible pipes, P.P./HDPE pipes, rubber pipes, hose pipes, seamless, ERW pipes & tubes, fittings, PVC goods etc.

Board of Directors:

- Mrs. Smita S Patel
- Mrs. Taruna P Patel
- Mr. Sanjay J Patel
- Mr. Piyush J Patel

Interest of our promoters:

Our promoters and promoters group hold 100% equity shares of this company.

Capital Structure:

Particulars	No. of Equity Shares of ₹ 10 each
Authorised Capital	4,50,000
Issued, Subscribed and Paid-up Capital	4,50,000



Financial Information:

The brief financial details of TEPL derived from its audited financial statements for Fiscals 2017, 2016 and 2015 are set forth below:

(₹ in lakhs)

Sr. No.	Particulars	As at March 31		
		2017	2016	2015
1.	Equity Shares	45.00	45.00	45.00
2.	Reserves and Surplus	76.07	69.64	65.18
3.	Net Worth	120.92	114.45	109.95
4.	Income including Other Income	723.28	1,587.69	2,404.57
5.	Profit/ (Loss) After Tax	6.44	4.45	8.56
6.	Earnings Per Share	1.43	0.99	1.90
7.	Net Asset Value Per Share	26.87	25.43	24.43

There are no significant notes of the auditors in relation to the aforementioned financial statements.

Other disclosures:

- The equity shares of TEPL are not listed on any stock exchange;
- TEPL is neither a sick company within the meaning of the Sick Industrial Companies (Special Provisions) Act, 1985 nor is under winding up. Further, TEPL has not made any losses in the immediately preceding year, and also do not have a negative net-worth in the immediately preceding year.
- No application has been made to RoC for striking off the name of TEPL;
- TEPL is not prohibited from accessing the capital markets for any reasons by the SEBI or any other authorities.

There are no defaults in meeting any statutory /bank/institutional dues. No proceedings have been initialled for economic offences against the Company.

NATURE AND EXTENT OF THE INTEREST OF THE GROUP COMPANIES IN OUR COMPANY

In the promotion of our Company

Our Group Company do not have any interest in the promotion of our Company.

In the properties acquired by our Company

Our Group Company do not have any interest in the properties acquired by our Company within the two years of the date of filing this Prospectus or proposed to be acquired by our Company.

In transactions for acquisition of land, construction of building and supply of machinery

Our Group Company do not have any interest in our Company in relation to transactions for acquisition of land, construction of building and supply of machinery.

Payment of amount or benefits to our Group Company during the last two years

Except as disclosed in the section “*Financial Information – Annexure XXV - Related Party Transactions*” beginning on page no. 169 of this Prospectus, no amount or benefits were paid or were intended to be paid to our Group Company during the last two years.

Common Pursuits of our Group Company

Our Group Company, Tembo Exim Private Limited has undertaken business activity similar to ours in the segment of trading of fabric and textile related products as per its past history. Our Company has not adopted any measures for mitigating such conflict situations.



However, Tembo Exim Private Limited also deals in all varieties, characteristics, of pipes, plastic materials, rubber materials, rigid and flexible pipes, P.P./HDPE pipes, rubber pipes, hose pipes, seamless, ERW pipes & tubes, fittings, PVC goods etc. As on date, there is no material conflict of interest pertaining to said line of business.

Related business transactions with the Group Company and its significance on the financial performance of our Company

For details, please see the chapter titled “*Financial Statements- Annexure XXV - Related Party Transactions*” on page no. 151 of this Prospectus.

Sale/purchase between our Group Company and our Company (exceeding 10% in aggregate of the total sales or purchases of our Company)

For details, please see the chapter titled “*Financial Statements- Annexure XXV - Related Party Transactions*” on page no. 169 of this Prospectus.

Defunct Group Companies

None of the Group Companies are defunct and no application has been made to the registrar of companies for striking off the name of any of the Group Companies during the five years preceding the date of this Prospectus.

Outstanding Litigations

For details relating to the material legal proceedings involving our Group Company, see the chapter titled “*Outstanding Litigations and Material Developments*” on page no. 191 of this Prospectus.

Other Confirmations

Our Group Company have further confirmed that it has not been declared as wilful defaulters and there have been no violations of securities laws committed by it in the past and no proceedings pertaining to such penalties are pending against them except as stated under chapters “*Risk Factors*”, “*Our Group Company*” and “*Outstanding Litigations and Material Developments*” on page nos. 15, 146 and 191 of this Prospectus, respectively. Additionally, our Group Company have not been restrained from accessing the capital markets for any reasons by the SEBI or any other authorities except as stated under chapters “*Risk Factors*”, “*Our Group Company*” and “*Outstanding Litigations and Material Developments*” on page nos. 15, 146 and 191 of this Prospectus, respectively.



CURRENCY, UNITS OF PRESENTATION AND EXCHANGE RATES

All references to “Rupees”, “Rs.” or “₹” are to Indian Rupees, the official currency of the Republic of India. All references to “US\$” or “US Dollars” or “USD” are to United States Dollars, the official currency of the United States of America.

This Prospectus may contain conversions of certain US Dollar and other currency amounts into Indian Rupees that have been presented solely to comply with the requirements of the SEBI Regulations. These conversions should not be construed as a representation that those US Dollar or other currency amounts could have been, or can be converted into Indian Rupees, at any particular rate.



DIVIDEND POLICY

Under the Companies Act, 2013, our Company can pay dividends upon a recommendation by our Board of Directors and approval by a majority of the shareholders at the General Meeting. The shareholders of our Company have the right to decrease, not to increase the amount of dividend recommended by the Board of Directors. The dividends may be paid out of profits of our Company in the year in which the dividend is declared or out of the undistributed profits or reserves of previous fiscal years or out of both. The Articles of Association of our Company also gives the discretion to our Board of Directors to declare and pay interim dividends.

There are no dividends declared by our Company since incorporation.

Our Company does not have any formal dividend policy for the Equity Shares. The declaration and payment of dividend will be recommended by our Board of Directors and approved by the shareholders of our Company at their discretion and will depend on a number of factors, including the results of operations, earnings, capital requirements and surplus, general financial conditions, applicable Indian legal restrictions and other factors considered relevant by our Board of Directors.



SECTION VI – FINANCIAL INFORMATION

FINANCIAL STATEMENTS

To,
The Board of Directors,
Saketh Exim Limited
Plot No- PAP D- 146/ 147, TTC MIDC
Turbhe, Navi Mumbai- 400705

Dear Sirs,

Re.: Proposed Public Issue of Equity Shares of Saketh Exim Limited

1. We have examined Financial Statements and Other Financial Information of Saketh Exim Limited (the 'Company') formerly known as Saketh Exim Private Limited, taking into consideration the terms of reference and terms of our engagement agreed upon with you in connection with the proposed IPO of the Company and the Guidance Note (Revised) on Reports in Company Prospectuses issued by the Institute of Chartered Accountants of India.
2. The said Restated Financial Statements and other Financial Information have been prepared for the purposes of inclusion in the Prospectus (collectively hereinafter referred to as "Offer Document") in connection with the proposed Initial Public Offer ("IPO") of the Company in accordance with the requirements of:
 - i. Sub-clauses (i) and (iii) of clause (b) of sub-section (1) of section 26 of the Companies Act, 2013 read with applicable provisions within Rule 4 to 6 of Companies (Prospectus and Allotment of Securities) Rules, 2014, as amended (hereinafter referred to as the "Act");
 - ii. The Securities and Exchange Board of India (Issue of Capital and Disclosure Requirements) Regulations, 2009 (the 'SEBI Regulations') and the related clarifications issued by the Securities and Exchange Board of India ('SEBI'); as amended to date;
3. We have examined the accompanied 'Restated Statement of Profit and Loss' (**Annexure – II**) for the Financial years ended on March 31, 2018, 2017, 2016, 2015 and 2014 and the 'Restated Statement of Assets and Liabilities' (**Annexure – I**) as on those dates, forming Part of the 'Financial Information' dealt with by this Report, detailed below. Both read together with the Significant Accounting Policies and Notes to Accounts (**Annexure – IV & V**) thereon, which are the responsibility of the Company's management. The information have been extracted from the financial statements for the financial year ended on March 31, 2017, 2016, 2015 and 2014 audited by M/s. Jayant & Company (FRN: 139504W), Chartered Accountants, being the Statutory Auditors of the Company for the respective years and for the Financial year ended March 31, 2018 audited by us; R A Maru & Associates, Chartered Accountants, being the Statutory Auditors of the Company for the respective period and approved by the Board of Directors. We did not carry out any validation tests or review procedures of financial statements for aforesaid financial year audited by M/s. Jayant & Company, Chartered Accountants and upon which we have placed our reliance while reporting.
4. In terms of Schedule VIII, Clause IX (9) of the SEBI (ICDR) Regulations, 2009 and other provisions relating to accounts of Saketh Exim Limited, we, R A Maru & Associates, have been subjected to the peer review process of the Institute of Chartered Accountants of India (ICAI) and hold a valid certificate issued by the Peer Review Board of the ICAI.
5. Based on our examination, we further report that:
 - a. The Restated Statement of Assets and Liabilities of the Company as at March 31, 2018, 2017, 2016, 2015 and 2014 examined by us, as set out in **Annexure I** to this examination report are after making adjustments and regrouping as in our opinion were appropriate and more fully described in the statement of significant accounting policies in **Annexure IV** and the Notes to Accounts in **Annexure V**.
 - b. The Restated Statement of Profit and Loss of the Company for the Financial years ended on March 31, 2018, 2017, 2016, 2015 and 2014 examined by us, as set out in **Annexure II** to this examination report are after



making adjustments and regrouping as in our opinion were appropriate and more fully described in the statement of significant accounting policies in **Annexure IV** and the Statement of Adjustments to the audited financial statements in **Annexure V**.

- c. The Restated Statement of Cash Flows of the Company for the Financial year ended on March 31, 2018, 2017, 2016, 2015 and 2014 examined by us, as set out in **Annexure III** to this examination report are after making adjustments and regrouping as in our opinion were appropriate and more fully described in the statement of significant accounting policies in **Annexure IV** and the Notes to Accounts in **Annexure V**.
- d. The Restated Financial Statements have been made after incorporating adjustments for:
 - i. The changes, if any, in accounting policies retrospectively in respective financial years to reflect the same accounting treatment as per the changed accounting policy for all the reporting period /years.
 - ii. Prior period and other material amounts in the respective financial years to which they relate.

Which are stated in the Notes to Accounts as set out in **Annexure V**

- e. Such Financial statements do not require any corrective adjustments on account of Extra-ordinary items that need to be disclosed separately in the accounts requiring adjustments.
6. At the request of the company, we have also examined the following financial information (“Other Financial Information”) proposed to be included in the offer document prepared by the management and approved by the board of directors of the company and annexed to this report:

- i) Statement of Share Capital (Annexure - VI)
- ii) Statement of Reserves & Surplus (Annexure - VII)
- iii) Statement of Fixed Assets (Annexure - VIII)
- iv) Statement of Non- Current Investments (Annexure – IX)
- v) Statement of Long term Loans and Advances (Annexure – X)
- vi) Statement of Other Non- Current Assets (Annexure – XI)
- vii) Statement of Inventories (Annexure – XII)
- viii) Statement of Trade Receivables (Annexure – XIII)
- ix) Statement of Cash and Cash Equivalents (Annexure – XIV)
- x) Statement of Short Term Loans and Advances (Annexure – XV)
- xi) Statement of Other Current Assets (Annexure – XVI)
- xii) Statement of Long Term Borrowings (Annexure – XVII)
- xiii) Statement of Short Term Borrowings (Annexure – XVIII)
- xiv) Statement of Trade Payables (Annexure –XIX)
- xv) Statement of Other Current Liabilities (Annexure – XX)
- xvi) Statement of Short Term Provisions (Annexure – XXI)
- xvii) Statement of Revenue from Operations (Annexure – XXII)
- xviii) Statement of Other Income (Annexure – XXIII)
- xix) Statement of Dividend Declared (Annexure – XXIV)
- xx) Statement of Related Party Transactions (Annexure –XXV)
- xxi) Statement of Capitalization (Annexure –XXVI)
- xxii) Statement of Accounting Ratios (Annexure – XXVII)
- xxiii) Statement of Tax Shelter (Annexure – XXVIII)
- xxiv) Statement showing Segment Reporting (Annexure – XXIX)

7. In our opinion, the Restated Financial Statements and the other Financial Information set forth in Annexure I to XXIX read with the significant accounting policies and notes to the restated financial statements have been prepared in accordance with section 26, read with applicable provisions within Rule 4 to 6 of Companies (Prospectus and Allotment of Securities) Rules, 2014 of Companies Act, 2013 and the SEBI Regulations and the Guidance Note on the reports in Company Prospectus (Revised) issued by the Institute of Chartered Accountants of India (ICAI).

Consequently the financial information has been prepared after making such regroupings and adjustments as were, in our opinion, considered appropriate to comply with the same. As a result of these regrouping and adjustments,



the amount reported in the financial information may not necessarily be the same as those appearing in the respective audited financial statements for the relevant years.

8. This report should not in any way construed as a reissuance or redrafting of any of the previous audit report issued by the Statutory Auditors nor should this report be construed as new opinion on or Re-Audit of any of the financial statement referred to therein.
9. We have no responsibility to update our report for events and circumstances occurring after the date of the report.
10. This report is intended solely for your information and for inclusion in the Offer document in connection with the Company's proposed IPO of equity shares and is not to be used, referred to or distributed for any other purpose without our prior written consent.

For R A Maru & Associates,
Chartered Accountants
(Firm Registration No. 141914W)

Rumeet Anil Maru.
Proprietor
Membership No: 166417

Place: Mumbai
Date: July 14, 2018



Annexure I
STATEMENT OF ASSETS AND LIABILITIES, AS RESTATED

(₹ in lakhs)

Particulars	As at March 31,				
	2018	2017	2016	2015	2014
EQUITY AND LIABILITIES					
Shareholder's fund					
a) Equity Share Capital	390.00	200.00	200.00	200.00	50.00
b) Reserves and surplus	368.86	296.64	201.08	124.06	83.75
Share Application Money Pending Allotment	-	-	-	-	-
Total Shareholders Fund (Net of revaluation reserve)	758.86	496.64	401.08	324.06	133.75
Non-current liabilities					
a) Long Term Borrowings	506.69	202.32	98.61	78.68	116.85
Total	506.69	202.32	98.61	78.68	116.85
Current liabilities					
a) Short-term borrowings	1,288.38	737.52	754.36	557.30	440.75
b) Trade payables	918.08	676.62	227.54	737.06	738.80
c) Other Current Liabilities	245.26	276.35	37.33	95.15	112.63
d) Short-term provisions	-	56.33	43.10	20.31	8.03
Total	2,451.72	1,746.82	1,059.32	1,409.81	1,300.21
TOTAL	3,717.27	2,445.78	1,562.01	1,812.55	1,550.80
ASSETS					
Non - Current Assets					
a) Fixed Assets					
i) Tangible assets	-	-	-	-	-
Gross Block	630.12	498.00	349.03	242.51	220.61
Less: Accumulated Depreciation	204.42	146.49	87.55	49.59	30.96
Net Block	425.71	351.51	261.48	192.92	189.65
b) Non- Current Investments	-	-	-	100	-
c) Deferred Tax Assets	11.17	15.21	7.37	2.94	0.99
d) Long term Loans & Advances	15.57	10.52	11.15	9.85	16.83
e) Other Non Current Assets	27.04	-	-	0.08	0.15
Total	479.48	377.24	280.00	305.79	207.62
Current Assets					
b) Inventories	698.45	486.60	100.98	176.23	251.13
b) Trade Receivables	2,104.51	1,376.77	966.51	1,060.02	762.54
c) Cash and Cash equivalents	119.83	52.10	32.20	8.38	2.70
d) Short-term loans and advances	308.52	2.08	47.83	170.67	291.21
e) Other Current Assets	6.46	150.99	134.49	91.46	35.60
Total	3,237.79	2,068.54	1,282.00	1,506.76	1,343.18
TOTAL	3,717.27	2,445.78	1,562.01	1,812.55	1,550.80



Annexure II
STATEMENT OF PROFIT AND LOSS ACCOUNT, AS RESTATED

(₹ in lakhs)

Particulars	For the year ended March 31,				
	2018	2017	2016	2015	2014
INCOME:					
Revenue from Operations	6,182.36	5,132.56	4,668.77	3,748.30	3,320.96
Other Income	17.40	7.90	3.34	1.14	0.19
Total income (A)	6,199.76	5,140.47	4,672.11	3,749.45	3,321.15
EXPENSES:					
Cost of materials consumed	4,722.19	4,855.78	4,162.29	3,408.31	3,288.11
(Increase)/ Decrease in Inventories	(396.27)	(385.62)	75.25	74.91	(160.02)
Employee benefits expense	149.58	112.94	75.83	40.42	29.30
Finance cost	189.50	142.65	102.03	88.28	68.93
Depreciation and amortization expense	57.93	58.94	37.96	18.63	13.26
Administration and other expenses	1,321.76	213.80	105.86	61.43	62.64
Total expenses (B)	6,044.68	4,998.49	4,559.22	3,691.98	3,302.22
Profit before extraordinary items and tax (C)	155.07	141.97	112.88	57.47	18.93
Prior period items (Net)	-	-	-	-	-
Profit before exceptional, extraordinary items and tax (A-B)	155.07	141.97	112.88	57.47	18.93
Exceptional items	-	-	-	-	-
Profit before extraordinary items and tax	155.07	141.97	112.88	57.47	18.93
Extraordinary items	-	-	-	-	-
Profit before tax (D)	155.07	141.97	112.88	57.47	18.93
<i>Tax expense :</i>					
(i) Current tax	52.00	54.26	40.29	19.11	6.37
(ii) Deferred Tax	(4.05)	(7.84)	(4.43)	(1.95)	(0.76)
Total Tax Expense (E)	47.95	46.42	35.87	17.15	5.62
Profit for the year (D-E)	107.12	95.55	77.02	40.31	13.31



Annexure III
CASH FLOW STATEMENT, AS RESTATED

(₹ in lakhs)

Particulars	As at March 31,				
	2018	2017	2016	2015	2014
Cash flow from operating activities:					
Net Profit before tax as per Profit And Loss A/c	155.07	141.97	112.88	57.47	18.93
Adjusted for:					
Depreciation & amortization	57.93	58.94	37.96	18.63	13.26
Interest & Finance Cost	189.50	142.65	102.03	88.28	68.93
Operating Profit Before Working Capital Changes	402.50	343.56	252.87	164.38	101.12
Adjusted for (Increase)/ Decrease:					
Trade Receivables	(727.74)	(410.27)	93.51	(297.48)	(361.54)
Inventories	(211.86)	(385.62)	75.25	74.91	(160.02)
Short Term Loans and Advances	(306.45)	45.75	122.84	120.53	(174.89)
Other Current Assets	144.53	(16.50)	(43.04)	(55.86)	(14.59)
Other Non- current Assets	(27.04)	-	0.08	0.08	0.08
Long Term Loans and Advances	(5.05)	0.63	(1.30)	6.98	(3.67)
Trade Payables	241.45	449.08	(509.52)	(1.74)	478.88
Other Current Liabilities	(31.09)	239.02	(57.82)	(17.49)	104.99
Short Term Provisions	(49.12)	13.24	22.79	12.28	0.87
Cash Generated From Operations Before Extra-Ordinary Items	(569.86)	278.92	(44.33)	6.59	(28.76)
Add:- Extra-Ordinary Items	-	-	-	-	-
Cash Generated From Operations	(569.86)	278.90	(44.33)	6.59	(28.76)
Direct Tax Paid	52.00	54.26	40.29	19.11	6.37
Net Cash Flow from/(used in) Operating Activities:(A)	(621.86)	224.64	(84.62)	(12.52)	(35.13)
Cash Flow From Investing Activities:					
Purchase of Fixed Assets	(132.13)	(148.97)	(106.52)	(21.90)	(7.58)
(Increase) / Decrease in Non Current Investments	-	-	100.00	(100.00)	-
Net Cash Flow from/(used in) Investing Activities: (B)	(132.13)	(148.97)	(6.52)	(121.90)	(7.58)
Cash Flow from Financing Activities:					
Proceeds From Share Capital	60.00	-	-	150.00	
Increase / (Decrease) Long Term Borrowing	304.37	103.72	19.93	(38.17)	(52.05)
Increase / (Decrease) in Short Term Borrowing	550.86	(16.84)	197.06	116.55	163.48
Interest & Financial Charges paid	(189.50)	(142.65)	(102.03)	(88.28)	(68.93)
Proceeds From Securities Premium Account	96.00	-	-	-	-
Net Cash Flow from/(used in) Financing Activities (C)	821.74	(55.77)	114.96	140.10	42.50
Net Increase/(Decrease) in Cash & Cash Equivalents (A+B+C)	67.75	19.90	23.82	5.68	(0.21)
Cash & Cash Equivalents As At Beginning of the Year	52.10	32.20	8.38	2.70	2.91
Cash & Cash Equivalents As At End of the Year	119.85	52.10	32.20	8.38	2.70

Note: The cash flow statement has been prepared on the basis of restated statement of profit & loss and balance sheet.



Annexure IV SIGNIFICANT ACCOUNTING POLICIES

1) METHOD OF ACCOUNTING

a) Basis of accounting and preparation of financial statements

These financial statements are prepared in accordance with Indian Generally Accepted Accounting Principles (GAAP) under the historical cost convention on the accrual basis except for certain financial instruments which are measured at fair values. GAAP comprises mandatory accounting standards as prescribed by the Companies (Accounting Standards) Rules, 2006, the provisions of the Companies Act, 1956. Accounting policies have been consistently applied.

b) Use of estimates

The preparation of the financial statements in conformity with Indian GAAP requires the Management to make estimates and assumptions considered in the reported amounts of assets and liabilities (including contingent liabilities) and the reported income and expenses during the year. The Management believes that the estimates used in preparation of the financial statements are prudent and reasonable. Future results could differ due to these estimates and the differences between the actual results and the estimates are recognised in the periods in which the results are known / materialise.

c) The accounting policies adopted in preparation of the financial statements are consistent with those followed in the previous year.

2) FIXED ASSETS AND DEPRECIATION

a) Fixed Assets are stated at cost less accumulated depreciation. Cost is inclusive of material cost, freight, duties, levies and other incidental expenditure attributable to bring the assets to their working condition for intended use.

b) Depreciation is provided as per useful life of the respective assets as prescribed in Schedule II of the Companies Act, 2013.

3) REVENUE RECOGNITION

(i) Revenue from the sale of products is recognized on dispatch of goods to the customer, which corresponds to transfer of significant risk and reward of ownership and is-net off excise duty, sales tax and trade discounts.

(ii) Other Income

Interest income is accounted on accrual basis. Dividend income is accounted for when the right to receive it is established.

4) LEASES

a) Where the Company is the Lessee –

Leases where the lessor effectively retains substantially all the risks and benefits of ownership of the leased term are classified as operating leases. Operating lease payments are recognized as an expense in the Profit and Loss Account on a straight-line basis over the lease term.

Assets taken on Finance Lease are accounted for as assets of the Company. Lease rentals are apportioned between principal and interest by applying an implicit rate of return and finance charge is recognized accordingly.

b) Where the Company is the Lessor-

Assets subject to operating leases are included in fixed assets. Lease income is recognized in the Profit and Loss Account on a straight-line basis over the lease term. Costs, including depreciation are recognized as a; expense in



the Profit and Loss Account. Initial direct costs such as legal costs, brokerage costs, etc. are recognized immediately in the Profit and Loss Account.

5) INVENTORIES

Inventories are valued at Lower of cost or net realizable value. Cost is Determined on a FIFO basis.

6) FOREIGN CURRENCY TRANSACTIONS

Transactions denominated in foreign currency are recorded at the exchange rate prevailing on the date of transaction or that approximates the actual rate at the date of transactions and any Income or Expense on Account of Exchange difference either on settlement or on translation is recognised in the statement of Profit & Loss.

7) EMPLOYEE BENEFITS:

The Amount of Short term employee benefits expected to be paid in exchange for the services rendered by employees are recognised as an expense during the period when the employees render the services and there is no post employment benefit is payable to the employees hence these are not accounted for short term employee benefits are charged off in the year in which the related services are rendered.

8) INVENTORIES

Inventories are valued at Lower of cost or net realizable value. Cost is Determined on a FIFO basis.

9) INVESTMENTS

Current Investments are carried at cost or market value whichever is lower and Long term Investments are stated at cost as per the Accounting Standard-13 Investment Accounting Issued by ICAI.

10) EARNINGS PER SHARE (EPS):

The Basic EPS is computed by dividing the net / profit (loss) attributable to the equity shareholders for the year by the weighted average number of equity shares outstanding during the reporting period. Diluted EPS is computed by dividing the net profit / (loss) as adjusted for dividend, interest and other charges to expense or income (net off any attributable taxes) relating to the dilutive potential equity shares by the weighted average number of equity and dilutive equity equivalent shares outstanding during the year, except where the results would be anti-dilutive.

11) TAXATION:

- (i) Tax expense comprises both current and deferred taxes. Provision is made for income tax liability, which is likely to arise on the results for the year at the current rate of tax in accordance with the provisions of Income Tax Act, 1961.
- (ii) Deferred tax resulting from the “timing difference” between book and taxable profits is accounted for using the tax rates and laws that have been enacted or substantively enacted as on the balance sheet date. The deferred tax asset is recognized and carried forward only to the extent that there is a reasonable certainty that the assets will be realized in the future.

12) PROVISIONS, CONTINGENT LIABILITIES AND CONTINGENT ASSETS:

Provisions involving substantial degree of estimation in measurement are recognized when there is a present obligation as a result of past events and it is probable that there will be an outflow of resources. A disclosure for a contingent liability is made when there is a possible obligation or a present obligation that may, but probably will not require an out flow of resources. Contingent assets are neither recognized nor disclosed in the financial statements.



13) SEGMENT REPORTING

The Segment Reporting is based on the following Accounting Policies adopted by the Company which is in line with the regular accounting policies.

- (i) Revenue and Expenses directly relatable to the Segment has been ascertained on the basis of their relationship to the activities of the Segment.
- (ii) Expenses not relatable to segment and not allocable have been included under unallocated Expenses.

As per AS- 17 of ICAI, the Company has identified product wise segment i.e. Manufacturing of Engineering Products and Trading of Fabric and Textile Products. Further there is a secondary segment based on the Geographical area.

- 14)** There are no Auditor's Qualifications in any of the audited Financial Statements for the financial year ended as at March 31, 2018, 2017, 2016, 2015 and 2014.



Annexure V
NOTES TO ACCOUNTS

1. Managerial Remuneration

(₹ in lakhs)

Particulars	For the year ended March 31,				
	2018	2017	2016	2015	2014
Executive Directors Remuneration					
Salaries and Allowances	47.00	60.00	45.00	24.00	16.00
Non-Executive Directors Remuneration					
Sitting Fees	-	-	-	-	-
Other Fees	-	-	-	-	-
Total	47.00	60.00	45.00	24.00	16.00

2. Deferred Tax

(₹ in lakhs)

Particulars	For the year ended March 31,				
	2018	2017	2016	2015	2014
Deferred Tax Liabilities					
Opening Balance	-	-	-	-	-
Timing Difference in Depreciation for the year	4.05	-	-	-	-
Total Deferred Tax Liability	4.05	-	-	-	-
Deferred Tax Assets					
Opening Balance	15.21	7.37	2.94	0.99	0.23
Timing Difference in Depreciation for the year	-	7.84	4.43	1.95	0.76
Total Deferred Tax Assets	15.21	15.21	7.37	2.94	0.99
Closing Balance of Deferred Tax Liabilities / (Assets)	11.17	15.21	7.37	2.94	0.99

3. Remuneration to Statutory Auditors

(₹ in lakhs)

Particulars	For the year ended March 31,				
	2018	2017	2016	2015	2014
Statutory Audit Fees	0.75	0.75	0.57	0.25	0.34
Tax Audit Fees	0.25	0.25	0.20	0.25	0.34
Certification work	-	-	-	-	-
Others	-	-	-	-	-
Total	1.00	1.00	0.77	0.50	0.67

4. The Company has not received any information from the vendors regarding their status under the Micro, Small and Medium Enterprises Development Act, 2006. Hence the disclosure with regard to amounts unpaid as at the period end together with interest paid / under the said Act has not been given.

5. Previous year figures have been re-grouped and reclassified wherever necessary to confirm to the current year classification.

6. Information regarding Foreign Exchange earnings and expenditure:

(₹ in lakhs)

Particulars	For the year ended March 31,				
	2018	2017	2016	2015	2014
Earning in Foreign Exchange	3,426.68	2,046.84	1,746.07	1,137.78	589.76
Expenditure in Foreign Exchange	14.71	82.25	24.42	4.44	13.92



ADJUSTMENTS MADE IN RESTATED FINANCIAL STATEMENTS / REGROUPING NOTES

Adjustments having impact on profit

(₹ in lakhs)

Particulars	For the year ended March 31,				
	2018	2017	2016	2015	2014
Other Income as per Audited Financial Statements	-	150.70	116.07	63.83	24.47
Less: Amount reclassified as Revenue from Operations (Other Operating Income)	-	(142.79)	(112.73)	(62.69)	(24.29)
Other Income as per Restated Financial Statements	-	7.90	3.34	1.14	0.19

(₹ in lakhs)

Particulars	For the year ended March 31,				
	2018	2017	2016	2015	2014
Revenue from Operations as per Audited Financial Statements	6,228.30	4,975.75	4,545.70	3,675.16	3,293.85
Add/(Less): Amount reclassified from Other Income	-	142.79	112.73	62.69	24.29
Add/ (Less): Amount Restated due to Foreign Exchange Valuation	45.94	14.02	10.34	10.45	2.83
Revenue from Operations as per Restated Financial Statements (Including Other Operating Income)	6,182.36	5,132.56	4,668.77	3,748.30	3,320.96

(₹ in lakhs)

Particulars	For the year ended March 31,				
	2018	2017	2016	2015	2014
Depreciation as per Audited Financial Statements	-	34.48	20.59	13.12	13.30
Add/ (Less): Amount Restated	-	24.46	17.37	5.51	(0.04)
Depreciation as per Restated Financial Statements	-	58.94	37.96	18.63	13.26

⁽¹⁾ Depreciation effect is already given in the Financials for the period ended March 31, 2018 as Prior Period adjustments.

(₹ in lakhs)

Particulars	For the year ended March 31,				
	2018	2017	2016	2015	2014
Other Expense as per Audited Financial Statements	-	234.88	119.80	63.90	64.12
Add/ (Less): Amount Restated	-	(2.77)	(0.19)	(2.47)	2.84
Add/(Less): Amount reclassified as Finance Cost	-	(9.25)	(3.28)	-	(4.33)
Less: Amount classified as Current Tax	-	2.83			
Other Expense as per Restated Financial Statements	-	220.04	116.34	61.43	62.64

(₹ in lakhs)

Particulars	For the year ended March 31,				
	2018	2017	2016	2015	2014
Deferred Tax Expense as per Audited Financial Statements	-	0.00	0.00	0.00	0.00
Add/ (Less): Amount Restated	-	(7.84)	(4.43)	(1.95)	(0.76)
Deferred Tax Expense as per Restated Financial Statements	-	(7.84)	(4.43)	(1.95)	(0.76)



Impact on Profit After tax is as under:

(₹ in lakhs)

Particulars	For the year ended March 31,				
	2018	2017	2016	2015	2014
Profit after tax as per Audited Financial Statements	112.16	97.82	81.53	32.38	12.26
Add/(Less): Deferred Tax Asset/(Liability) Adjustment	(15.21)	7.84	4.43	1.95	0.76
Add/(Less): Change in Depreciation	47.00	(24.46)	(17.37)	(5.51)	0.04
Add/(Less): Amount Restated due to Foreign Exchange Gain/ Loss and Preliminary Expense	(45.94)	16.79	10.52	12.93	(0.01)
Add/(Less): Provision of Income tax	7.33	(2.44)	(2.09)	(1.43)	0.28
Add/(Less): TDS wrongly deducted written off	(0.89)				
Profit after tax as per Restated Financial Statements	107.12	95.55	77.02	40.31	13.31

Other Regroupings/ Restatements

Various figures have been re-grouped/ restated in order to match the treatment of relevant line item as per the latest audited figures. There is no impact on "PAT" from the above re-groupings/ restatements.

Annexure VI

STATEMENT OF SHARE CAPITAL, AS RESTATED

(₹ in lakhs)

Particulars	As at March 31,				
	2018	2017	2016	2015	2014
Authorised Share capital					
5,00,000 Equity Shares of Rs. 10/- each	-	-	-	-	50.00
20,00,000 Equity Shares of Rs. 10/- each	-	200.00	200.00	200.00	-
39,00,000 Equity Shares of Rs. 10/- each	390.00	-	-	-	-
Total	390.00	200.00	200.00	200.00	50.00
Issued, Subscribed and Fully Paid Up Share Capital					
50,000 Equity Shares of Rs. 10/- each (Fully Paid Shares)	-	-	-	-	50.00
20,00,000 Equity Shares of Rs. 10/- each (Fully Paid Shares)	-	200.00	200.00	200.00	-
39,00,000 Equity Shares of Rs. 10/- each	390.00	-	-	-	-
Total	390.00	200.00	200.00	200.00	50.00

Reconciliation of number of shares outstanding:

Particulars	As at March 31,				
	2018	2017	2016	2015	2014
Equity Shares of ₹ 10/- each					
Equity shares at the beginning of the year	20,00,000	20,00,000	20,00,000	5,00,000	5,00,000
Add:- Increase in quantity of Shares on account of new allotment	-	-	-	15,00,000	-
Add:-Equity Shares issued as bonus during the period	13,00,000	-	-	-	-
Add: Equity Shares issued as Right Shares	6,00,000	-	-	-	-
Equity Shares at the end of the year	39,00,000	20,00,000	20,00,000	20,00,000	5,00,000

Annexure VII

STATEMENT OF RESERVES AND SURPLUS, AS RESTATED

(₹ in lakhs)

Particulars	As at March 31,				
	2018	2017	2016	2015	2014
a). Surplus					
Opening balance of Statement of Profit & Loss	243.63	148.7	71.05	30.74	17.42
<u>Add / (Less): Changes during the year</u>					
Profit After Tax	107.12	95.55	77.02	40.31	13.32



Particulars	As at March 31,				
	2018	2017	2016	2015	2014
Less: TDS Wrongly Deducted w/off	(0.90)	-	-	-	-
Closing balance of Statement of Profit & Loss	349.85	243.63	148.07	71.05	30.74
b). Securities Premium Account					
Opening Balance	53.01	53.01	53.01	53.01	53.01
Add : Shares Premium	96.00	-	-	-	-
Less: Amount utilized for issue of Bonus Shares during the period	130.00				
Closing Balance	19.01	53.01	53.01	53.01	53.01
Total	368.86	296.64	201.08	124.06	83.75

Annexure VIII
STATEMENT OF FIXED ASSETS, AS RESTATED

(₹ in lakhs)

Particulars	As at March 31,				
	2018	2017	2016	2015	2014
TANGIBLE ASSETS					
Land					
Opening Balance (Gross Block)	128.45	108.61	108.61	108.61	108.61
Addition during the year	-	19.83	-	-	-
Reduction during the year	-	-	-	-	-
Depreciation during the year	-	-	-	-	-
Accumulated Depreciation	-	-	-	-	-
Closing Balance (Net Block)	128.45	128.45	108.61	108.61	108.61
Building					
Opening Balance (Gross Block)	43.96	43.96	43.96	43.96	41.46
Addition during the year	-	-	-	-	2.50
Reduction during the year	-	-	-	-	-
Depreciation during the year	(1.47)	(1.54)	(1.61)	(1.69)	(3.75)
Accumulated Depreciation	(14.25)	(12.78)	(11.24)	(9.63)	(7.94)
Closing Balance (Net Block)	29.72	31.18	32.72	34.33	36.02
Factory Shed					
Opening Balance (Gross Block)	3.83	3.83	3.83	3.83	-
Addition during the year	-	-	-	-	3.83
Reduction during the year	-	-	-	-	-
Depreciation during the year	(0.16)	(0.16)	(0.17)	(0.18)	(0.11)
Accumulated Depreciation	(0.78)	(0.63)	(0.46)	(0.29)	(0.11)
Closing Balance (Net Block)	3.04	3.20	3.36	3.54	3.71
Plant and Machinery					
Opening Balance (Gross Block)	166.71	98.96	31.47	11.47	10.72
Addition during the year	113.48	67.75	67.49	20.01	0.74
Reduction during the year	-	-	-	-	-
Depreciation during the year	(31.52)	(25.80)	(16.54)	(5.29)	(1.37)
Accumulated Depreciation	(81.65)	(50.13)	(24.33)	(7.79)	(2.50)
Closing Balance (Net Block)	198.53	116.58	74.63	23.68	8.97
Furniture and Fixture					
Opening Balance (Gross Block)	87.35	42.46	41.34	41.34	41.14
Addition during the year	7.78	44.88	1.13	-	0.20
Reduction during the year	-	-	-	-	-



Particulars	As at March 31,				
	2018	2017	2016	2015	2014
Depreciation during the year	(12.62)	(15.56)	(5.48)	(7.23)	(5.62)
Accumulated Depreciation	(56.63)	(44.01)	(28.45)	(22.97)	(15.74)
Closing Balance (Net Block)	38.50	43.33	14.01	18.36	25.60
Motor Vehicle					
Opening Balance (Gross Block)	37.07	30.37	4.72	4.72	4.72
Addition during the year	-	6.70	25.65	-	-
Reduction during the year	-	-	-	-	-
Depreciation during the year	5.52	(8.00)	(8.61)	1.00	1.10
Accumulated Depreciation	24.70	(19.18)	(11.19)	(2.58)	(1.58)
Closing Balance (Net Block)	12.37	17.89	19.18	2.14	3.14
Air Conditioner					
Opening Balance (Gross Block)	3.66	1.39	1.39	1.39	1.39
Addition during the year	-	2.27	-	-	-
Reduction during the year	-	-	-	-	-
Depreciation during the year	0.54	(0.73)	(0.20)	(0.28)	(0.16)
Accumulated Depreciation	2.17	(1.64)	(0.91)	(0.71)	(0.42)
Closing Balance (Net Block)	1.49	2.02	0.48	0.68	0.97
Electrical Installations and Equipments					
Opening Balance (Gross Block)	10.06	9.10	0.44	0.31	0.13
Addition during the year	6.08	0.96	8.65	0.13	0.18
Reduction during the year	-	-	-	-	-
Depreciation during the year	2.51	(1.96)	(2.32)	(0.10)	(0.04)
Accumulated Depreciation	6.96	(4.45)	(2.48)	(0.17)	(0.06)
Closing Balance (Net Block)	9.17	5.61	6.61	0.28	0.25
Office Equipment					
Opening Balance (Gross Block)	1.21	1.21	1.21	1.21	1.21
Addition during the year	-	-	-	-	-
Reduction during the year	-	-	-	-	-
Depreciation during the year	-	(0.05)	(0.20)	(0.54)	(0.14)
Accumulated Depreciation	(1.15)	(1.15)	(1.10)	(0.91)	(0.36)
Closing Balance (Net Block)	0.06	0.06	0.11	0.31	0.85
Computers					
Opening Balance (Gross Block)	15.70	9.13	5.53	3.77	3.64
Addition during the year	4.80	6.57	3.60	1.76	0.13
Reduction during the year	-	-	-	-	-
Depreciation during the year	3.60	(5.14)	(2.83)	(2.30)	(0.98)
Accumulated Depreciation	16.11	(12.52)	(7.38)	(4.54)	(2.24)
Closing Balance (Net Block)	4.38	3.18	1.76	0.99	1.53
Tangible Gross Block	630.12	498.00	349.03	242.51	220.61
Total Accumulated Depreciation	(204.42)	(146.49)	(87.55)	(49.59)	(30.96)
Depreciation For the year	(57.93)	(58.94)	(37.96)	(18.63)	(13.26)
Net Block	425.71	351.51	261.48	192.92	189.65



Annexure IX
STATEMENT OF NON CURRENT INVESTMENTS, AS RESTATED

(₹ in lakhs)

Particulars	As at March 31,				
	2018	2017	2016	2015	2014
a) Investment in Mutual Fund					
BOI Axa Regular Return Fund	-	-	-	50.00	-
BOI Axa Short Term Fund	-	-	-	50.00	-
Total	-	-	-	100.00	-

Annexure X
STATEMENT OF LONG TERM LOANS AND ADVANCES, AS RESTATED

(₹ in lakhs)

Particulars	As at March 31,				
	2018	2017	2016	2015	2014
Security Deposits	15.57	10.52	11.15	9.85	16.83
Total	15.57	10.52	11.15	9.85	16.83

Annexure XI
STATEMENT OF OTHER NON- CURRENT ASSETS, AS RESTATED

(₹ in lakhs)

Particulars	As at March 31,				
	2018	2017	2016	2015	2014
Preliminary Expense	26.63	-	-	0.08	0.15
Advance payments of Income Tax	0.41	-	-	-	-
Total	27.04	-	-	0.08	0.15

Annexure XII
STATEMENT OF INVENTORIES, AS RESTATED

(₹ in lakhs)

Particulars	As at March 31,				
	2018	2017	2016	2015	2014
Closing Stock	698.45	486.60	100.98	176.23	251.13
Total	698.45	486.60	100.98	176.23	251.13

Annexure XIII
STATEMENT OF TRADE RECEIVABLES, AS RESTATED

(₹ in lakhs)

Particulars	As at March 31,				
	2018	2017	2016	2015	2014
Unsecured, considered good					
Outstanding for a period less than six months	2,104.51	1,376.77	944.33	1,028.73	762.54
Outstanding for a period exceeding six months	-	-	22.18	31.29	-
Total	2,104.51	1,376.77	966.51	1,060.02	762.54

Details of Trade Receivables from Related Parties:

(₹ in lakhs)

Particulars	As at March 31,				
	2018	2017	2016	2015	2014
Associate Concerns	-	-	-	-	-
Holding Company	-	-	-	-	-
Key Management Person	-	-	-	-	-
Total	-	-	-	-	-



Annexure XIV
STATEMENT OF CASH AND CASH EQUIVALENTS, AS RESTATED

(₹ in lakhs)

Particulars	As at March 31,				
	2018	2017	2016	2015	2014
Cash On Hand	1.20	0.06	0.23	0.28	2.65
Balance With Banks	-				
In Current Account	0.11	0.21	5.11	0.10	0.05
In Deposit Account	118.54	51.83	26.85	8.00	-
Total	119.84	52.10	32.20	8.38	2.70

Annexure XV
STATEMENT OF SHORT TERM LOANS AND ADVANCES, AS RESTATED

(₹ in lakhs)

Particulars	As at March 31,				
	2018	2017	2016	2015	2014
Unsecured and Considered Good	-				
Loans and Advances to Employees	0.18	-	0.69	0.20	-
Loan Given to Related party	-	-	-	102.84	76.37
Advance Given to Creditors	10.89	2.08	2.69	13.83	214.69
Balance with Revenue authorities	294.20				
Other Loans and Advances:					
Capital Advances	3.25	-	-	-	-
Loan Given to others	-	-	44.45	53.80	0.15
Total	308.52	2.08	47.83	170.67	291.21

Annexure XVI
STATEMENT OF OTHER CURRENT ASSETS, AS RESTATED

(₹ in lakhs)

Particulars	As at March 31,				
	2018	2017	2016	2015	2014
Duty Drawback Receivable	-	18.59	24.16	40.16	8.63
Sales Proceeds of Focus License sold	-	-	-	-	-
VAT/ CST Receivable	-	101.31	81.66	47.02	24.79
TDS Receivable	2.83	-	0.72	0.28	0.18
Advance Income Tax paid	-	31.09	18.00	4.00	2.00
Interest receivable	3.64				
Others	-	-	9.95	-	-
IGST on export refundable	-	-	-	-	-
Total	6.46	150.99	134.49	91.46	35.60

Annexure XVII
STATEMENT OF LONG TERM BORROWINGS, AS RESTATED

(₹ in lakhs)

Particulars	As at March 31,				
	2018	2017	2016	2015	2014
Secured Loans					
Term Loan	63.55	8.43	11.21	3.50	8.95
Car Loan	3.20	2.49	12.39	-	-
<u>From Financial Institutions</u>					
Small Industries Development Bank of India		-	-	-	-
Total	66.75	10.92	23.61	3.50	8.95
Unsecured Loans					
<u>Loans from:</u>					
Directors	240.28	3.00	-	-	-



Particulars	As at March 31,				
	2018	2017	2016	2015	2014
Related Parties (ICD)		-	-	-	-
Related Parties		-	-	18.58	-
Banks and Non- Banking Financial Institutions	199.65	188.40	-	6.60	58.90
Others(ICD)	-	-	75.00	50.00	49.00
Total	439.94	191.40	75.00	75.18	107.90
Grand Total	506.69	202.32	98.61	78.68	116.85
Current Maturity to Long Term Debt	198.17	251.69	31.73	84.71	100.14

Note: For details of the Terms of Sanction, Maturity and other details of outstanding loans please refer *Annexure A - Financial Indebtedness*.

Annexure XVIII
STATEMENT OF SHORT TERM BORROWINGS, AS RESTATED

(₹ in lakhs)

Particulars	As at March 31,				
	2018	2017	2016	2015	2014
Secured Loan					
From Banks	1288.38	737.52	738.56	507.82	342.25
Unsecured Loan					
Directors	-	-	16.00	49.48	98.50
Total	1288.38	737.52	754.56	557.30	440.75

Note: For details of the Terms of Sanction, Maturity and other details of outstanding loans please refer *Annexure A - Financial Indebtedness*.

The above amounts in Annexure XVII and XVIII include:

(₹ in lakhs)

Particulars	As at March 31,				
	2018	2017	2016	2015	2014
Secured Borrowing (including current maturities)	1,375.17	761.25	778.51	521.71	363.64
Unsecured Borrowing(including current maturities)	618.07	430.28	106.18	198.97	294.09
Total	1,993.24	1,191.53	884.69	720.68	657.73

Note: For details of the Terms of Sanction, Maturity and other details of outstanding loans please refer *Annexure A - Financial Indebtedness*.

Annexure XIX
STATEMENT OF TRADE PAYABLES, AS RESTATED

(₹ in lakhs)

Particulars	As at March 31,				
	2018	2017	2016	2015	2014
<u>Trade Payable</u>					
For Goods	853.01	639.36	207.81	718.07	726.40
For Expense	65.07	37.27	19.73	18.99	12.40
Total	918.08	676.62	227.54	737.06	738.80

Annexure XX
STATEMENT OF OTHER CURRENT LIABILITIES, AS RESTATED

(₹ in lakhs)

Particulars	As at March 31,				
	2018	2017	2016	2015	2014
<u>Current Maturities of Long Term Borrowings</u>					
Secured Loans					
Term Loan from Bank	20.04	5.19	12.60	10.40	12.44
Car Loan	-	7.63	3.95	-	-
Unsecured Loans					



Particulars	As at March 31,				
	2018	2017	2016	2015	2014
Bank and Non- Banking Financial Institutions	178.13	238.88	15.18	74.32	87.70
<u>Others</u>					
Statutory Liabilities	17.48	8.16	5.60	4.86	1.16
Other Payables	9.19	-	-	-	0.41
Advances from debtors	20.41	16.49	-	5.57	10.93
Total	245.26	276.35	37.33	95.15	112.63

Annexure XXI
STATEMENT OF SHORT TERM PROVISIONS, AS RESTATED

(₹ in lakhs)

Particulars	As at March 31,				
	2018	2017	2016	2015	2014
Income Tax Provision	-	56.33	43.10	20.31	8.03
Total	-	56.33	43.10	20.31	8.03

Annexure XXII
STATEMENT OF REVENUE FROM OPERATIONS, AS RESTATED

(₹ in lakhs)

Particulars	For the year ended March 31,				
	2018	2017	2016	2015	2014
REVENUE FROM OPERATIONS					
Sale of Products					
<u>Revenue from Manufacturing</u>					
Export Sales	3,426.68	2,046.84	1,746.07	1,137.78	589.76
Local Sales	72.84	21.98	71.89	75.04	0.68
Total (A)	3,499.52	2,068.82	1,817.96	1,212.82	590.45
<u>Revenue from Trading</u>					
Local Sales (Fabric)	1,283.27	-	-	-	-
Exempt Sales	1,114.45	2,888.78	2,727.74	2,462.34	2,703.40
Total(B)	2,397.72	2,888.78	2,727.74	2,462.34	2,703.40
TOTAL (C)	5,897.24	4,957.60	4,545.70	3,675.16	3,293.85
Other Operating Income					
Duty Drawback	93.63	114.88	106.22	60.85	23.36
Gain on Foreign Exchange	23.13	32.14	12.60	3.27	2.83
Sale of Product License	116.80	18.15	4.25	1.09	0.92
Freight Charges on Sales	40.91	-	-	-	-
Rebate for Quantity and Rate Difference	10.64	9.79	-	7.92	-
Total(D)	285.12	174.96	123.07	73.14	27.12
TOTAL (C+D)	6,182.36	5,132.56	4,668.77	3,748.30	3,320.96

Annexure XXIII
STATEMENT OF OTHER INCOME, AS RESTATED

(₹ in lakhs)

Particulars	For the year ended March 31,				
	2018	2017	2016	2015	2014
Discount Received	1.01	4.17	0.64	1.14	0.04
Bank Interest	2.17	3.41	-	0.01	0.15
Interest on RD	5.73	-	-	-	-
Insurance compensation received	6.25	-	-	-	-
Interest on VAT Refund	1.28	-	-	-	-
Miscellaneous Income	0.96	0.32	2.69	-	-



Particulars	For the year ended March 31,				
	2018	2017	2016	2015	2014
Total	17.40	7.90	3.34	1.14	0.19
Net Profit Before Tax as Restated	155.07	141.97	112.88	57.47	18.93
Other Income as a %age of PBT	11.22%	5.57%	2.96%	1.99%	0.99%

Annexure XXIV
STATEMENT OF DIVIDEND DECLARED, AS RESTATED

(₹ in lakhs)

Particulars	For the year ended March 31,				
	2018	2017	2016	2015	2014
On Equity Shares					
Fully Paid up Share Capital (₹ in lakhs)	390.00	200.00	200.00	200.00	50.00
Face Value (₹)	10.00	10.00	10.00	10.00	10.00
Paid up value per share (₹)	10.00	10.00	10.00	10.00	10.00
Rate of Dividend	-	-	-	-	-
Total Dividend	-	-	-	-	-
Corporate Dividend tax on above	-	-	-	-	-

Annexure XXV
STATEMENT OF RELATED PARTY TRANSACTIONS, AS RESTATED

As per Accounting Standard 18 on related party disclosure issue by the Institute of Chartered Accountants of India, the Company's related parties are disclosed below:

(i) Key Managerial Personnel

For the year ended March 31,				
2018	2017	2016	2015	2014
Sanjay Patel	Sanjay Patel	Sanjay Patel	Sanjay Patel	Sanjay Patel
Smita Patel	Smita Patel	Smita Patel	Smita Patel	Smita Patel
Taruna Patel	Taruna Patel	Taruna Patel	Taruna Patel	Taruna Patel
Shabbir Merchant (CFO)				

(ii) Relatives of KMPs

For the year ended March 31,				
2018	2017	2016	2015	2014
Piyush Patel	Piyush Patel	Piyush Patel	Piyush Patel	Piyush Patel
-	-	-	-	Priyanka Patel
-	-	Shalin Patel	Shalin Patel	-

(iii) Associates / Enterprises over which directors and / or their relatives has significant influence

For the year ended March 31,				
2018	2017	2016	2015	2014
Tembo Exim Pvt. Ltd.	Tembo Exim Pvt. Ltd.	Tembo Exim Pvt. Ltd.	Tembo Exim Pvt. Ltd.	Tembo Exim Pvt. Ltd.
B.M.Electro Mechanical LLP				



(iv) Particulars of Transactions with Related Parties

Key Management Personnel

(₹ in lakhs)

Particulars	For the year ended March 31,				
	2018	2017	2016	2015	2014
1) Finance					
Loan Taken	604.16	337.80	31.00	2.48	98.50
Repayment of Loan taken	366.88	350.80	64.48	51.50	-
Loan Given		-	-	-	-
Repayment of Loan given		-	-	-	-
Equity Contribution		-	-	99.00	-
2) Expenses					
Salary		-	-	-	-
Interest Paid	11.09	-	-	-	-
Remuneration	47.00	60.00	45.00	24.00	16.00

Relatives of Key Managerial Personnel

(₹ in lakhs)

Particulars	For the year ended March 31,				
	2018	2017	2016	2015	2014
1) Finance					
Loan Taken	-	-	-	18.58	-
Repayment of Loan taken	-	-	18.58	-	-
Loan Given	-	-	-	-	4.00
Repayment of Loan given	-	-	-	-	4.00
Equity Contribution	-	-	-	51.00	-
2) Expenses					
Salary	24.00	20.00	18.50	8.00	6.00

Associates / Enterprises over which directors and / or their relatives has significant influence

(₹ in lakhs)

Particulars	For the year ended March 31,				
	2018	2017	2016	2015	2014
1) Finance					
Loan Taken	-	347.43	-	-	-
Repayment of Loan taken	-	347.43	-	-	-
Loan Given	-	-	262.70	226.15	304.69
Repayment of Loan given	-	-	365.54	199.68	228.32
Job work charges paid to B.M. Electro Mechanical	328.20	-	-	-	-
Interest Paid	23.28	-	-	-	-

Annexure XXVI

STATEMENT OF CAPITALIZATION

(₹ in lakhs)

Particular	Pre Issue (as at March 31, 2018)	Post Issue
Debt		
Long Term Debt (including current maturities to long term debt)	704.86	704.86
Short Term Debt	1,288.38	1,288.38
Total Debts (A)	1,993.24	1,993.24
Equity (Shareholder's funds)		
Equity share capital	390.00	502.30
Reserve and Surplus	368.86	1,031.53



Particular	Pre Issue (as at March 31, 2018)	Post Issue
Total Equity (B)	758.86	1,533.73
Long Term Debt (including current maturities to long term debt) / Equity Shareholder's funds	0.93	0.46
Total Debts / Equity Shareholder's funds	2.63	1.30

Note:

- The above has been computed on the basis of Restated Financials of the Company.

Annexure XXVII

STATEMENT OF ACCOUNTING RATIOS, AS RESTATED

(₹ in lakhs)

Particulars	For the year ended March 31,				
	2018	2017	2016	2015	2014
Restated PAT as per P & L Account	107.12	95.55	77.02	40.31	13.31
Actual Number of Equity Shares outstanding at the end of the year	39,00,000	20,00,000	20,00,000	20,00,000	5,00,000
Equivalent Weighted Average number of Equity Shares at the end of the year	36,21,686	32,05,479	32,05,479	15,17,773	14,88,258
Reserves & Surplus	368.86	297.53	201.98	124.96	84.65
Misc. Expenses not w/o	26.63	-	-	0.08	0.15
Net Worth	732.23	497.53	401.98	324.88	134.49
Earnings Per Share:⁽¹⁾					
Basic & Diluted	2.96	2.98	2.40	2.66	0.89
Return on Net Worth (%)	14.63%	19.24%	19.20%	12.44%	9.97%
Net Asset Value Per Share (₹) - based on actual no. of equity shares of ₹ 10/- each at the end of the year	18.78	24.88	20.05	16.20	26.72
Nominal Value per Equity share (₹)	10.00	10.00	10.00	10.00	10.00

⁽¹⁾The calculation for EPS in the Restated Financials is as per the guidelines of AS-20 issued by the ICAI.

Notes on Accounting Ratios:

- The above statement should be read with the Significant accounting policies and notes to accounts appearing in Annexure IV & V respectively.
- Basic EPS is being calculated by using the formula: (Net Profit after excluding Extra-ordinary items /Equivalent Weighted Average No. of outstanding shares)
- Net Asset Value is being calculated by using the formula: (Net Worth /Actual Number of Equity Shares at year end)
- Return on Net worth is being calculated by using the formula: (Profit after Tax / Net worth)

Other Notes:

- There is no revaluation reserve in last five years in our company.
- As there is no dilutive capital in the company, Basic and Diluted EPS are similar.
- Weighted average no. of equity shares are calculated after giving effect for right issue made on November 07, 2017 and bonus issue made on March 20, 2018.

Annexure XXVIII

STATEMENT OF TAX SHELTER

(₹ in lakhs)

Particulars	For the year ended March 31,				
	2018	2017	2016	2015	2014
Tax Rates					
Income Tax Rate (%)	27.55%	34.61 %	33.06 %	30.90 %	30.90 %
I. Income from Business or Profession					



Particulars	For the year ended March 31,				
	2018	2017	2016	2015	2014
Restated Profit before tax as per books (A)	155.07	141.97	112.88	57.47	18.93
Adjustments :					
Items considered separately (B)					
Deferred Tax	(4.05)	(7.84)	(4.43)	(1.95)	(0.76)
Total Items considered separately (B)	(4.05)	(7.84)	(4.43)	(1.95)	(0.76)
Permanent Differences (C)					
Interest on TDS	-	-	0.02	-	-
Total Permanent Differences (C)		-	0.02	-	-
Timing Differences (D)					
Book Depreciation	57.93	58.94	37.96	18.63	13.26
Income Tax Depreciation Allowance	72.61	36.28	24.57	12.32	10.81
Total Timing Differences (D)	(14.69)	22.66	13.39	6.31	2.45
Net Adjustments (E) = (B+C+D)	(18.73)	14.82	8.98	4.36	1.69
Income from Business or Profession (F) = (A+E)	136.34	156.79	121.86	61.83	20.62
Gross Total Income	136.34	156.79	121.86	61.83	20.62
Deduction Under Chapter VI A					
Donation	-	-	-	-	-
Total Deduction under Chapter VI A		-	-	-	-
Taxable Income/(Loss)	136.34	156.79	121.86	61.83	20.62
Income Tax on above	37.56	54.26	40.29	19.11	6.37
Tax paid as per normal or MAT	Normal	Normal	Normal	Normal	Normal
Total Tax as per Return	50.95	47.95	38.27	15.66	6.61
Difference	(13.39)	6.31	2.02	3.45	(0.24)

Notes:

1. The aforesaid Statement of tax Shelters has been prepared as per the 'Restated Profit and Loss Account.

CHANGES IN ACCOUNTING POLICIES IN THE LAST THREE YEARS FOR THE YEAR ENDED 31ST MARCH 2018, 2017 AND 2016

There has been no change in the Accounting Policies in the last three (3) years

CHANGES IN ACCOUNTING PERIOD

There has been no change in the accounting period of the Company.

**Annexure XXIX
STATEMENT SHOWING SEGMENT REPORT**

Segment Report Based On Product-Wise

(₹ in lakhs)

Particulars	For the year ended March 31,				
	2018	2017	2016	2015	2014
SEGMENT REVENUE					
Manufacturing of Engineering Products	3,784.64	2,243.78	1,941.03	1,285.96	617.56
Trading of Fabrics of and Textile Material	2,397.72	2,888.78	2,727.74	2,462.34	2,703.40
Net Sales/ Income from Operations	6,182.36	5,132.56	4,668.77	3,748.30	3,320.96
SEGMENT RESULTS					
Manufacturing of Engineering Products	311.77	283.82	179.97	123.16	45.98
Trading of Fabrics of and Textile Material	25.86	(15.96)	25.20	14.99	31.62
SEGMENT RESULTS	337.63	267.87	205.17	138.16	77.60
Less:					
a) Interest Expense	(182.56)	(125.89)	(92.29)	(80.69)	(58.67)
b) Other Un-allocable Expenditure/ (Income) net		-	-	-	-



Particulars	For the year ended March 31,				
	2018	2017	2016	2015	2014
Profit/ (loss) after finance cost but before exceptional items	155.07	141.97	112.88	57.47	18.93
Exceptional Items (Net)		-	-	-	-
Total Profit/ (Loss) before tax	155.07	141.97	112.88	57.47	18.93
SEGMENT ASSETS					
Manufacturing of Engineering Products	2,502.13	1,830.13	1,150.68	996.77	907.69
Trading of Fabrics of and Textile Material	1,215.15	616.55	412.23	816.68	644.01
SEGMENT ASSETS	3,717.28	2446.68	1562.91	1813.45	1551.70
SEGMENT LIABILITIES					
Manufacturing of Engineering Products	2,488.41	1,640.19	1,050.80	939.09	1,285.61
Trading of Fabrics of and Textile Material	470.00	308.96	110.13	549.4	131.44
SEGMENT LIABILITIES	2,958.41	1,949.15	1,160.93	1,488.49	1,417.05

Segment Report Based On Geographical Area-wise

(₹ in lakhs)

Particulars	For the year ended March 31,				
	2018	2017	2016	2015	2014
SALES:					
Domestic	2,587.36	2,928.92	2,803.88	2,538.48	2,705.00
Export	3,595.00	2,203.65	1,864.89	1,209.83	615.96
Total	6,182.36	5,132.56	4,668.77	3,748.30	3,320.96



MANAGEMENT’S DISCUSSION AND ANALYSIS OF FINANCIAL CONDITION AND RESULTS OF OPERATIONS

You should read the following discussion and analysis of financial condition and results of operations together with our financial statements included in this Prospectus. The following discussion relates to our Company and is based on our restated financial statements. Our financial statements have been prepared in accordance with Indian GAAP, the accounting standards and other applicable provisions of the Companies Act.

Note: Statement in the Management Discussion and Analysis Report describing our objectives, outlook, estimates, expectations or prediction may be "Forward looking statement" within the meaning of applicable securities laws and regulations. Actual results could differ materially from those expressed or implied. Important factors that could make a difference to our operations include, among others, economic conditions affecting demand/supply and price conditions in domestic and overseas market in which we operate, changes in Government Regulations, Tax Laws and other Statutes and incidental factors.

Our Company manufactures and fabricates various steel products which are meant for its application in Pipe Support Systems, HVAC Systems, Anti-vibration System and Equipments for Industrial, Commercial, Utility and OEM Installations. We manufacture various engineering products, metal and base metal products like G. I. nuts, various types of bolts, clamps, hangers etc. Further our Product Portfolio includes all types of bathroom pipes, fittings, bathroom accessories and sanitary wares.

The following diagram depicts the breakup of revenue, percentage-wise for financial year ended March 31, 2018 on the basis of Manufacturing and Trading segments.

Revenue Model	
Manufacturing (61.22%) ⁽¹⁾	Trading (38.78%) ⁽¹⁾

⁽¹⁾Percentage (%) is calculated as a percentage of Total Sale of Products.

Certain products manufactured by us are certified by Underwriter’s Laboratory Inc. (U.S.A) and FM Global Approved (U.S.A) which are meant to be used for Fire Sprinklers System Installations. Further, we are certified by Dun & Bradstreet which helps us in growing relationships through their global database and helps us in exploring the new potential customers.

We are certified by ISO 9001:2015 for manufacturing of various products i.e. UL and FM approved Pipe Hangers and Support Systems, Anti vibration products, Rubber support inserts, valves, S.S. Floor Drains. This certification confirms to the Quality Management System of our Company in relation to the manufacturing of various products.

Our Company has 3 manufacturing units located at Vasai. These manufacturing units are strategically located providing locational advantages. Our Company has installed various plant and machinery at our manufacturing facilities for manufacturing and fabrication of the varied products. For further details regarding machineries, please refer to “*Our Business - Plant and Machinery*” on page no. 108 of this Prospectus.

Our Company exports its products to various geographies such as USA and various countries in Middle East serving to various companies of several industries. We have a good customer base in India as well as internationally. These customers have been a part of the growth story of our Company which we believe is essentially due to the product quality and customer centric approach of our Company. We also have a good customer base in India for the products manufactured by us.

Our Company is even engaged in trading of textile products. We trade into fancy shirting and finish fabrics. Based on the orders received from our Customers for the textile products, we order the exact requirement from our suppliers and make the final product available to our Customers.



COMPETITION

There is increasing competition in the pipe support hanger & related metal industry as well as textile Industry. Our Company manufactures various engineering products, metal and base metal products. These products are meant for its application in Pipe Support Systems, HVAC Systems, Anti-vibration System and Equipments for Industrial, Commercial, Utility and OEM Installations.

We face competition from various local domestic and international players. This industry is an unorganised industry and is fragmented with many small and medium sized companies and entities, which manufactures these products at various levels. Further, we face competition from the global market since our Company is mainly export oriented for the products manufactured by us. Over the years, we have developed a platform for our products in the International market due to various marketing strategies adopted by us.

Further, we are also engaged in trading of fabric and textile related products. Textile being a large global industry we face competition from various players in the market. The industry is largely unorganized and fragmented with many small and medium-sized companies and entities. We intend to continue competing vigorously to capture more market share and manage our growth in an optimal way.

We believe that the principal factors affecting competition in our business include client relationships reputation, the abilities of our management and operating team and market focus. We believe that our Company will not only maintain but further enhance its position in this Industry. Our reputation is based on the quality of the products manufactured by us and timeliness of delivery of the products.

Significant Developments after March 31, 2018 that may affect our Future Results of Operations

The Directors confirm that there have been no events or circumstances since the date of the last financial statements as disclosed in the Prospectus which materially or adversely affect or is likely to affect the profitability of our Company, or the value of our assets, or our ability to pay liabilities within next twelve months.

Factors affecting our Result of Operation

Except as otherwise stated in this Prospectus and the Risk Factors given in the Prospectus, the following important factors could cause actual results to differ materially from the expectations include, among others.

Revenue Generation

We earn our revenue from manufacturing and fabricating of various steel products which are meant for its application in Pipe Support Systems, HVAC Systems, Anti-vibration System and Equipments for Industrial, Commercial, Utility and OEM Installations. We manufacture various engineering products, metal and base metal products like G. I. nuts, various types of bolts, clamps, hangers etc. We are also engaged in trading of textile products. We trade into fancy shirtings and finish fabrics. Our revenue generation is based on the contracts received from the customers.

Since we continuously endeavour to provide quality products to our customers, our revenues are impacted by such quality products and services. We have a robust marketing team allocated amongst different segment, each handled by well trained personnel.

Our Financial Expenses

We have term loan and working capital facilities from our bankers. Our profitability is significantly impacted by our financial costs. For the year ended 2018, 2017 and 2016 our financial expenses were ₹ 189.50, ₹ 142.65 lakhs and ₹ 102.03 lakhs respectively. Our financial growth depends on how well we manage and service our debts.

Our ability to successfully implement its strategy and its growth and expansion plans

One of the key determinants of our results of operations will be our ability to implement our growth strategies. As a part of our overall growth strategy, we are planning to expand our product range and diversify and increase penetration in other markets and ensuring optimal utilisation of resources. Our ability to implement these strategies, within the time frame will be a key factor in our success, since we operate in an unorganised and fragmented industry.



Our growth plans are considerable and would put significant demands on our management team and other resources. Any delay in implementation of our strategy could impact our Company's outlook and cause more of cost and time.

Market Conditions and Demand for our Products and Services

Our results of operations depend on the continued existence, success and growth of, and demand for, our various product. Developments in the global and Indian economy influence the decisions of enterprises to determine their pricing strategy, market based factors and quality standards thereby affecting the demand for our products and services.

Our revenues have a mix of domestic and export sales, so consequently, our operating results depend on general economic conditions not only in India but also our major export market, namely, Middle East, USA etc. Further we earn our revenue from two segments i.e. Manufacturing of Engineering products and trading in fabric and other Textile Products, and the competitiveness factors relating to both the Industry affects the profitability of our Company

With the global economy showing varied patterns, Indian economy showing signs of recovery and the Indian Government's focus on financial inclusion, we expect the demand for our products and services to grow.



STATEMENT SHOWING SEGMENTAL REPORT

Segment Report Based On Product-Wise

(₹ in lakhs)

Particulars	For the year ended March 31,				
	2018	2017	2016	2015	2014
SEGMENT REVENUE					
Manufacturing of Engineering Products	3,784.64	2,243.78	1,941.03	1,285.96	617.56
Trading of Fabrics of and Textile Material	2,397.72	2,888.78	2,727.74	2,462.34	2,703.40
Net Sales/ Income from Operations	6,182.36	5,132.56	4,668.77	3,748.30	3,320.96
SEGMENT RESULTS					
Manufacturing of Engineering Products	311.77	283.82	179.97	123.16	45.98
Trading of Fabrics of and Textile Material	25.86	(15.96)	25.20	14.99	31.62
SEGMENT RESULTS	337.63	267.87	205.17	138.16	77.60
<u>Less:</u>					
a) Interest Expense	(182.56)	(125.89)	(92.29)	(80.69)	(58.67)
b) Other Un-allocable Expenditure/ (Income) net		-	-	-	-
Profit/ (loss) after finance cost but before exceptional items	155.07	141.97	112.88	57.47	18.93
Exceptional Items (Net)		-	-	-	-
Total Profit/ (Loss) before tax	155.07	141.97	112.88	57.47	18.93
SEGMENT ASSETS					
Manufacturing of Engineering Products	2,502.13	1,830.13	1,150.68	996.77	907.69
Trading of Fabrics of and Textile Material	1,215.15	616.55	412.23	816.68	644.01
SEGMENT ASSETS	3,717.28	2446.68	1562.91	1813.45	1551.70
SEGMENT LIABILITIES					
Manufacturing of Engineering Products	2,502.13	1,640.19	1,050.80	939.09	1,285.61
Trading of Fabrics of and Textile Material	470.00	308.96	110.13	549.4	131.44
SEGMENT LIABILITIES	2,958.41	1,949.15	1,160.93	1,488.49	1,417.05



Segment Report Based On Geographical Area-wise

(₹ in lakhs)

Particulars	For the year ended March 31,				
	2018	2017	2016	2015	2014
SALES:					
Domestic	2,587.36	2,928.92	2,803.88	2,538.48	2,705.00
Export	3,595.00	2,203.65	1,864.89	1,209.83	615.96
TOTAL	6,182.36	5,132.56	4,668.77	3,748.30	3,320.96

RESULTS OF OUR OPERATIONS

(₹ in lakhs)

Particulars	For the year ended March 31,							
	2018	% of Total Income	2017	% of Total Income	2016	% of Total Income	2015	% of Total Income
INCOME								
Revenue from Operations	6,182.36	99.72%	5,132.56	99.85%	4,668.77	99.93%	3,748.30	99.97%
Other Income	17.40	0.28%	7.90	0.15%	3.34	0.07%	1.14	0.03%
Total Income (A)	6,199.76	100.00%	5,140.47	100.00%	4,672.11	100.00%	3,749.45	100.00%
EXPENDITURE								
Cost of materials consumed	4,722.19	76.17%	4,855.78	94.46%	4,162.29	89.09%	3,408.31	90.90%
(Increase)/Decrease in Inventories	(396.27)	-6.39%	(385.62)	(7.50)%	75.25	1.61%	74.91	2.00%
Employee benefit expenses	149.58	2.41%	112.94	2.20%	75.83	1.62%	40.42	1.08%
Finance costs	189.50	3.06%	142.65	2.78%	102.03	2.18%	88.28	2.35%
Depreciation and Amortization expense	57.93	0.93%	58.94	1.15%	37.96	0.81%	18.63	0.50%
Administration & Other Expenses	1,321.76	21.32%	213.80	4.16%	105.86	2.27%	61.43	1.64%
Total Expenses (B)	6,044.68	97.50%	4,998.49	97.24%	4,559.22	97.58%	3,691.98	98.47%
Profit before extraordinary items and tax (C)	155.07	2.50%	141.97	2.76%	112.88	2.42%	57.47	1.53%
Prior Period Items	-		-	-	-	-	-	-
Profit before exceptional, extraordinary items and tax (A-B)	155.07	2.50%	141.97	2.76%	112.88	2.42%	57.47	1.53%
Exceptional items			-	-	-	-	-	-



Particulars	For the year ended March 31,							
	2018	% of Total Income	2017	% of Total Income	2016	% of Total Income	2015	% of Total Income
Net Profit/(Loss) before extraordinary items and tax (D)	155.07	2.50%	141.97	2.76%	112.88	2.42%	57.47	1.53%
Less: Tax expense								
Current tax	52.00	0.84%	54.26	1.06%	40.29	0.86%	19.11	0.51%
Deferred tax	(4.05)	-0.07%	(7.84)	(0.15)%	(4.43)	(0.09)%	(1.95)	(0.05)%
Total Tax Expense (E)	47.95	0.77%	46.42	0.90%	35.87	0.77%	17.15	0.46%
Net Profit/(Loss) for the period after tax (D-E)	107.12	1.73%	95.55	1.86%	77.02	1.65%	40.31	1.08%



Main Components of our Profit and Loss Account

Income

Our total income comprises of revenue from operations and other income.

Revenue from Operations

Our revenue from operations as a percentage of total income were 99.72%, 99.85% and 99.93% respectively, for the fiscals 2018, 2017 and 2016.

Other Income

Our other income comprises of interest income, discount received, insurance compensation received and miscellaneous income. Other income, as a percentage of total income was 0.28% 0.15% and 0.07% respectively, for the fiscals 2018, 2017 and 2016.

Expenditure

Our total expenditure primarily consists of Purchases (cost of Materials), Employee Benefit Expenses, Finance costs, Depreciation & Amortisation Expenses and Other Expenses.

Purchases & Direct Expenses

Costs of Purchases are primarily in relation to purchases of textile product for trading and raw materials for manufacturing of engineering products, metal and base metal products including G. I. nuts, various types of bolts, clamps, hangers etc

Employee Benefit Expenses

Expenses in relation to employees' remuneration and benefits include employee's salary, director's remuneration, staff welfare expenses etc.

Finance costs

Finance cost primarily consists of interest payable on loans availed by our company from banks & financial institutions and others.

Depreciation and Amortization Expenses

Depreciation and Amortization Expenses primarily consist of depreciation on the Tangible fixed assets of our Company which primarily includes Building, Factory Shed, Plant & Machinery Computer, Furniture and Fixtures, Office equipments etc

Other Expenses

Other expenses primarily include Rent, Advertisement Expenses, Certificate & Consultancy Charges, Commission, Electricity Charges, Travelling Expenses, Business Promotion Expenses, Printing & Stationery Expenses, Repairs & Maintenance Expenses etc

Provision for Tax

The provision for current taxation is computed in accordance with relevant tax regulation. Deferred tax is recognized on timing differences between the accounting and the taxable income for the year and quantified using the tax rates



and laws enacted or subsequently enacted as on balance sheet date. Deferred tax assets are recognized and carried forward to the extent that there is a virtual certainty that sufficient future taxable income will be available against which such deferred tax assets can be realized in future.

Fiscal 2018 compared with fiscal 2017

Income

In fiscal 2018, our total income increased by ₹ 1,059.29 lakhs or 20.61%, from ₹ 5,140.47 lakhs in fiscal 2017 to ₹ 6,199.76 lakhs in fiscal 2018. The increase in the year 2018 was due to increase in the revenue from operations as compared to last year.

Other income increased by ₹ 9.50 lakhs or 120.13%, from ₹ 7.90 lakhs in fiscal 2017 to ₹ 17.40 lakhs in fiscal 2018. The major factor for such increase was due to rise in interest income & discount received.

Cost of material consumed

Cost of material consumed decreased by ₹ 119.21 lakhs or 2.46%, from ₹ 4,855.78 lakhs in fiscal 2017 to ₹ 4,722.19 lakhs in fiscal 2018.

Changes in Inventories

Changes in Inventories had a variance by ₹ 10.65 from ₹ 385.62 lakhs in Fiscal 2017 to ₹ 396.27 lakhs in Fiscal 2018.

Employee Benefit Expenses

Our staff cost increased by ₹ 36.64 lakhs or 32.44%, from 112.94 lakhs in fiscal 2017 to ₹ 149.58 lakhs in fiscal 2018. This increase was mainly due to increase in number of employees in FY 2017-18.

Finance Cost

Finance cost during the year increased by ₹ 46.85 lakhs or 32.82%, from ₹ 142.65 lakhs in fiscal 2017 to ₹ 189.50 lakhs in fiscal 2018 due to increase in borrowings.

Depreciation and Amortization Expenses

Depreciation expenses decreased by ₹ 1.01 lakhs, from ₹ 58.94 lakhs in fiscal 2017 to ₹ 57.93 lakhs in fiscal 2018.

Other Expenses

Other expenses increased by ₹ 1,093.60 lakhs or 479.30% from ₹ 213.80 lakhs in fiscal 2017 to ₹ 1,321.76 lakhs in fiscal 2018. The increase was due to travelling expenses, postage & courier charges, office expenses, exhibition expenses, commission paid and increase in manufacturing expenses etc.

Profit before Tax

The increase in the revenue from operations has led to an increase in our Profit before tax by ₹ 13.10 lakhs from ₹ 141.97 lakhs in fiscal 2017 to ₹ 155.07 lakhs in fiscal 2018.



Profit after Tax

After accounting for taxes at applicable rates, our Profit after Tax increased by ₹ 11.57 lakhs or 12.10%, from ₹ 95.55 lakhs in fiscal 2017 to ₹ 107.12 lakhs in fiscal 2018.

Fiscal 2017 compared with fiscal 2016

Income

In fiscal 2017, our total income increased by ₹ 468.36 lakhs or 10.02%, from ₹ 4,672.11 lakhs in fiscal 2016 to ₹ 5,140.47 lakhs in fiscal 2017. The increase in the year 2017 was due to increase in the revenue from operations as compared to last year.

Other income increased by ₹ 4.57 lakhs or 136.93%, from ₹ 3.34 lakhs in fiscal 2016 to ₹ 7.90 lakhs in fiscal 2017. The major factor for such increase was due to rise in interest income & discount received.

Cost of material consumed

Cost of material consumed increased by ₹ 693.49 lakhs or 16.66%, from ₹ 4,162.29 lakhs in fiscal 2016 to ₹ 4,855.78 lakhs in fiscal 2017.

Changes in Inventories

Changes in Inventories had a variance by 460.88 from ₹ 75.25 lakhs in Fiscal 2016 to ₹ 385.62 lakhs in Fiscal 2017.

Employee Benefit Expenses

Our staff cost increased by ₹ 37.11 lakhs or 48.93%, from ₹ 75.83 lakhs in fiscal 2016 to ₹ 112.94 lakhs in fiscal 2017. This increase was mainly due to increase in number of employees in FY 2016-17.

Finance Cost

Finance cost during the year increased by ₹ 40.62 lakhs or 39.81%, from ₹ 102.03 lakhs in fiscal 2016 to ₹ 142.65 lakhs in fiscal 2017 due to increase in borrowings.

Depreciation and Amortization Expenses

Depreciation expenses increased by ₹ 20.98 lakhs, from ₹ 37.96 lakhs in fiscal 2016 to ₹ 58.94 lakhs in fiscal 2017. This increase was on account of additions of assets in FY 2016-17.

Other Expenses

Other expenses increased by ₹ 107.95 lakhs or 101.98% from ₹ 105.86 lakhs in fiscal 2016 to ₹ 213.80 lakhs in fiscal 2017. The increase was due to travelling expenses, postage & courier charges, office expenses, exhibition expenses, commission paid etc.

Profit before Tax

The increase in the revenue from operations has led to an increase in our Profit before tax by ₹ 29.09 lakhs from ₹A 112.88 lakhs in fiscal 2016 to ₹ 141.97 lakhs in fiscal 2017.



Profit after Tax

After accounting for taxes at applicable rates, our Profit after Tax increased by ₹ 18.54 lakhs or 24.07%, from ₹ 77.02 lakhs in fiscal 2016 to ₹ 95.55 lakhs in fiscal 2017.

Fiscal 2016 compared with fiscal 2015

Income

In fiscal 2016, our total income increased by ₹ 922.66 lakhs or 24.61%, from ₹ 3,749.45 lakhs in fiscal 2015 to ₹ 4,672.11 lakhs in fiscal 2016. The increase in the year 2016 was due to increase in the revenue from operation as compared to last year.

Other income increased by ₹ 2.19 lakhs or 191.66%, from ₹ 1.14 lakhs in fiscal 2015 to ₹ 3.34 lakhs in fiscal 2016. The decrease in the year 2016 was due to miscellaneous income & provision written off as compared to last year.

Cost of material consumed

Cost of material consumed increased by ₹ 753.98 lakhs or 22.12%, from ₹ 3,408.31 lakhs in fiscal 2015 to ₹ 4,162.29 lakhs in fiscal 2016.

Changes in Inventories

Changes in Inventories had a variance by 0.46% from ₹ 74.91 lakhs in Fiscal 2015 to ₹ 75.25 lakhs in Fiscal 2016

Employee Benefit Expenses

Our staff cost increased by ₹ 35.41 lakhs or 87.59%, from ₹ 40.42 lakhs in fiscal 2015 to ₹ 75.83 lakhs in fiscal 2016. This increase was mainly due to increase in number of employees in FY 2015-16.

Finance Cost

Finance cost during the year increased by ₹ 13.76 lakhs or 15.58%, from ₹ 88.28 lakhs in fiscal 2015 to ₹ 102.03 lakhs in fiscal 2016. The increase was due to increase in borrowings.

Depreciation and Amortization Expenses

Depreciation expenses increased by ₹ 19.33 lakhs or 103.76% from ₹ 18.63 lakhs in fiscal 2015 to ₹ 37.96 lakhs in fiscal 2016. This increase was on account of purchase of assets in FY 2015-16.

Other Expenses

Other expenses increased by ₹ 44.43 lakhs or 72.32% from ₹ 61.43 lakhs in fiscal 2015 to ₹ 105.86 lakhs in fiscal 2016. The increase was due to increase in administration expenses, electricity charges, commission charges & tours & travel expenses, postage and courier etc in fiscal 2016.

Profit before Tax

The increase in the revenue from operations has led to an increase in Profit before tax by ₹ 55.41 lakhs from ₹ 57.47 lakhs in fiscal 2015 to ₹ 112.88 lakhs in fiscal 2016.



Profit after Tax

After accounting for taxes at applicable rates, our Profit after Tax increased by ₹ 36.70 lakhs or 91.05 %, from ₹ 40.31 lakhs in fiscal 2015 to ₹ 77.02 lakhs in fiscal 2016.

Fiscal 2015 compared with fiscal 2014

Income

In fiscal 2015, our total income increased by ₹ 428.30 lakhs or 12.90%, from ₹ 3,321.15 lakhs in fiscal 2014 to ₹ 3,749.45 lakhs in fiscal 2015. The increase in the year 2015 was due to increase in the revenue from operations as compared to last year.

Other income increased by ₹ 0.96 lakhs or 507.35%, from ₹ 0.19 lakhs in fiscal 2014 to ₹ 1.14 lakhs in fiscal 2015. The major factor for such increase was increase in discount received.

Cost of material consumed

Cost of material consumed increased by ₹ 120.20 lakhs or 3.66%, from ₹ 3,288.11 lakhs in fiscal 2014 to ₹ 3,408.31 lakhs in fiscal 2015.

Changes in Inventories

Changes in Inventories had a variance by ₹ 234.93 lakhs from negative ₹ 160.2 lakhs in Fiscal 2014 to ₹ 74.91 lakhs in Fiscal 2015

Employee Benefit Expenses

Our staff cost increased by ₹ 11.12 lakhs or 37.94%, from ₹ 29.30 lakhs in fiscal 2014 to ₹ 40.42 lakhs in fiscal 2015. This increase was mainly due to increase in number of employees in FY 2014-15.

Finance Cost

Finance cost during the year increased by ₹ 19.35 lakhs or 28.07%, from ₹ 68.93 lakhs in fiscal 2014 to ₹ 88.28 lakhs in fiscal 2015. The increase was due to increase in borrowings.

Depreciation and Amortization Expenses

Depreciation expenses increased by ₹ 5.37 lakhs from ₹ 13.26 lakhs in fiscal 2014 to ₹ 18.63 lakhs in fiscal 2015. This increase was on account of purchase of fixed assets in FY 2014-15.

Other Expenses

Other expenses decreased by ₹ 1.21 lakhs or 1.93% from ₹ 62.64 lakhs in fiscal 2014 to ₹ 61.43 lakhs in fiscal 2015. The decrease was due to decrease in commission expenses, travelling expenses etc incurred in fiscal 2015.

Profit before Tax

Our Profit before tax is increased by ₹ 38.54 lakhs from ₹ 18.93 lakhs in fiscal 2014 to ₹ 57.47 lakhs in fiscal 2015 due to increase in revenue from operations.



Profit after Tax

After accounting for taxes at applicable rates, our Profit after Tax increased to profit of ₹ 40.31 lakhs in fiscal 2015 from ₹ 13.31 lakhs in fiscal 2014.

Cash Flows

(₹ in lakhs)

Particulars	For the Year ended March 31,		
	2018	2017	2016
Net Cash from Operating Activities	(569.86)	224.64	(84.62)
Net Cash from Investing Activities	(132.13)	(148.97)	(6.52)
Net Cash used in Financing Activities	821.74	(55.77)	114.96
Net Increase / (Decrease) in Cash and Cash equivalents	67.75	19.90	23.82

Cash Flows from Operating Activities

Net cash from operating activities in fiscal 2018 was negative ₹ 569.86 lakhs as compared to the PBT of ₹ 155.07 lakhs for the same period. This difference is primarily on account of depreciation, Interest paid, Inventories, Trade payables, Trade receivables, Short term loans & advances, other current assets, short term provisions, long term loans and advances and other current liabilities.

Net cash from operating activities in fiscal 2017 was ₹ 224.64 lakhs as compared to the PBT of ₹ 141.97 lakhs for the same period. This difference is primarily on account of depreciation, Interest paid, Inventories, Trade payables, Trade receivables, Short term loans & advances, other current assets, other non current assets, short term provisions, long term loans and advances and other current liabilities.

Net cash from operating activities in fiscal 2016 was negative ₹ 84.62 lakhs as compared to the PBT of ₹ 112.88 lakhs for the same period. This difference is primarily on account of depreciation, Interest paid, Inventories, Trade payables, Trade receivables, Short term loans & advances, other current assets, other non current assets, short term provisions, long term loans and advances and other current liabilities.

Cash Flows from Investment Activities

In fiscal 2018, the net cash invested in Investing Activities was negative ₹ 132.13 lakhs. This was on account of purchase of fixed assets.

In fiscal 2017, the net cash invested in Investing Activities was negative ₹ 148.97 lakhs. This was on account of purchase of fixed assets.

In fiscal 2016, the net cash invested in Investing Activities was negative ₹ 6.52 lakhs. This was on account of purchase of fixed assets which partially compensated by sale of investments.

Cash Flows from Financing Activities

Net cash from financing activities in fiscal 2018 was ₹ 821.74 lakhs. This was on account of increase in long term borrowings and Interest, decrease in short term borrowings.

Net cash from financing activities in fiscal 2017 was negative ₹ 55.77 lakhs. This was on account of increase in long term borrowings and Interest, decrease in short term borrowings.

Net cash from financing activities in fiscal 2016 was ₹ 114.96 lakhs. This was on account of increase in long term borrowings and increase in short term borrowings.



OTHER DISCLOSURES

Changes in Trade Receivables

Trade Receivables increased by ₹ 297.48 lakhs from ₹ 762.54 lakhs in fiscal 2014 to ₹ 1,060.02 lakhs in fiscal 2015. The increase was due to aggressive sales and credit policy followed by the Company.

Trade Receivables decreased by ₹ 93.51 lakhs from ₹ 1,060.02 lakhs in fiscal 2015 to ₹ 966.51 lakhs in fiscal 2016. The decrease was due to rationalised sales and credit policy followed by the Company.

Trade Receivables increased by ₹ 410.26 lakhs from ₹ 966.51 lakhs in fiscal 2016 to ₹ 1,376.77 lakhs in fiscal 2017. Since there was an increase in sales, the Company followed aggressive sales and credit policy in order to establish relationship with the customer and future business opportunities.

Changes in Trade Payables

Trade Payables decreased by ₹ 8.33 lakhs from ₹ 726.40 lakhs in fiscal 2014 to ₹ 718.07 lakhs in fiscal 2015. The decrease was due to payment of the amounts considering the purchase within the time frame of credit period considering the slight decrease in Purchase as compared to previous Fiscal.

Trade Payables decreased by ₹ 510.26 lakhs from ₹ 718.07 lakhs in fiscal 2015 to ₹ 207.81 lakhs in fiscal 2016. Such decrease was due to lower credit period taken by the Company in order to improve the margin levels.

Trade Payables increased by ₹ 431.55 lakhs from ₹ 207.81 lakhs in fiscal 2016 to ₹ 639.36 lakhs in fiscal 2017. Such increase was due to rationalized credit period taken by the Company for making payment to the suppliers, considering an increase in the Sales considering the previous year.

OTHER MATTERS

1. Unusual or infrequent events or transactions

Except as described in this Prospectus, during the periods under review there have been no transactions or events, which in our best judgment, would be considered unusual or infrequent.

2. Significant economic changes that materially affected or are likely to affect income from continuing Operations

Other than as described in the Section titled “*Financial Information*” and chapter titled “*Management’s Discussion and Analysis of Financial Conditions and Results of Operations*”, beginning on page nos. 151 and 174 respectively of this Prospectus respectively, to our knowledge there are no significant economic changes that materially affected or are likely to affect income from continuing Operations.

3. Known trends or uncertainties that have had or are expected to have a material adverse impact on revenue or income from continuing operations

Other than as described in the chapter titled “*Risk Factors*” and “*Management’s Discussion and Analysis of Financial Conditions and Result of Operations*”, beginning on page nos. 15 and 174 respectively of this Prospectus respectively to our knowledge there are no known trends or uncertainties that have or had or are expected to have a material adverse impact on revenues or income of our company from continuing operations.



4. Future relationship between Costs and Income

Other than as described in the chapter titled “*Risk Factors*” beginning on page no. 15 of this Prospectus, to our knowledge there are no factors, which will affect the future relationship between costs and income or which are expected to have a material adverse impact on our operations and finances.

5. The extent to which material increases in revenue or income from operations are due to increased volume, introduction of new products or services or increased prices

Increases in revenues are by and large linked to increases in introduction of new services and volume of business activity carried out by the Company.

6. Total turnover of each major industry segment in which our Company operates.

We manufacture and fabricate various steel products which are meant for its application in Pipe Support Systems, HVAC Systems, Anti-vibration System and Equipments for Industrial, Commercial, Utility and OEM Installations. We manufacture various engineering products, metal and base metal products like G. I. nuts, various types of bolts, clamps, hangers etc. Our Company is also engaged in Trading of Fabric and other textile related products. Relevant industry data, as available, has been included in the chapter titled “*Industry Overview*” beginning on page no. 83 of this Prospectus.

7. Status of any publicly announced new products or business segments

Please refer to the chapter titled “*Our Business*” beginning on page no. 96 of this Prospectus.

8. The extent to which the business is seasonal.

Our business is not seasonal in nature.

9. Any significant dependence on a single or few suppliers or customers

The revenues from our top 5 and top 10 customers constituted approximately 47.37% and 62.65 % respectively for fiscal 2018. For further details, please refer chapter “*Our Business*” beginning on page no. 96 of this Prospectus.

10. Competitive Conditions

Our Company faces competition from players in the global market, since we are export oriented unit for the goods manufactured by us. Further we are also engaged in Trading of Fabric and other Textile products, which is largely unorganized and fragmented industry.

We expect competition to intensify due to possible changes in government policy in relation to exports and further compliance standards for the products manufactured by us, existing competitors globally further expanding their operations and further many small and medium-sized companies and entities engaged in trading of fabric and textile related products. This we believe may impact our financial condition and operations.



FINANCIAL INDEBTEDNESS

Set forth below, is a brief summary of our Company's borrowings as on March 31, 2018 together with a brief description of certain significant terms / material covenants of the relevant financing arrangements.

(₹ in lakhs)

Nature of Borrowing	Amount
Secured Borrowings ⁽¹⁾	1,375.17
Unsecured Borrowings ⁽¹⁾	618.07
Total	1,993.24

⁽¹⁾ It includes ₹198.17 lakhs shown under Other Current Liabilities as 'Current Maturities of Long Term Debt'

Details of Secured Loans (other than vehicle loans)

(₹ in lakhs)

Name of Lenders	Type of Loan	Date of Sanction	Amount Sanctioned	Amount outstanding as on March 31, 2018	Interest (in % p.a.)	Security
SIDBI Bank	Term Loan	16/08/2017	77.00	70.83	9.60% upto a period of 3 years from date of 1 st disbursement ⁽¹⁾	Note 1
	Soft Loan		13.00	12.76	8.95% upto a period of 3 years from date of 1 st disbursement ⁽²⁾	Note 2
Bank of India	Working Capital Facilities	10/02/2017	900.00	1,288.38 ⁽³⁾	MCLR (8.50%)+ BSS (0.30%)+ CRR (2.50%)= 11.30% For Export Packing Credit and Foreign Bill Purchase /Foreign Bill negotiated as per banks extant guidelines	Note 3*
	Term Loan		17.00	-	MCLR (8.50%)+BSS(0.30%)+CRR(2.50%) =11.30%	Note 4

⁽¹⁾ Rate of Interest on Term Loan of SIDBI Bank – Upto a period of 3 years from the date of first disbursement the interest shall be payable at the rate of 9.60% p.a. (fixed), with monthly rests on principal amount of the term loan outstanding from time to time and thereafter interest shall be charged at the rate of 0.15% above SIDBI's Prime Lending Rate (PLR) rising or falling therewith, with monthly rests.

⁽²⁾ Rate of Interest on Term Loan of SIDBI Bank – Upto a period of 3 years from the date of first disbursement, interest shall be payable at the rate of 8.95% p.a. with monthly rests, on the principal amount of the soft loan outstanding from time to time. On expiry of 3 years from date of first disbursement or when the unit becomes ineligible for concessional funding under the scheme, whichever is earlier, interest shall be charged at 11.90% p.a. (floating).

⁽³⁾ In addition to above sanctioned facilities, our company, avails from time to time need based finance against acceptances of our Export sales [Bank to Bank Finance]. Due to this our outstanding amount is higher than the sanction facilities.

Note 1: Secured by First charge by way of hypothecation of all movables assets including Plant and Machinery, Machinery Spares, tools and accessories acquired/ to be acquired under the project/ scheme⁽³⁾. Further it is irrevocably and unconditionally guaranteed jointly and severally by Mr. Sanjay J Patel, Mrs. Smita S Patel and Mrs. Taruna P Patel.



Note 2: Secured by Residual charge by way of hypothecation of all movables assets including Plant and Machinery, Machinery Spares, tools and accessories acquired/ to be acquired under the project/ scheme⁽³⁾. Further it is irrevocably and unconditionally guaranteed jointly and severally by Mr. Sanjay J Patel, Mrs. Smita S Patel and Mrs. Taruna P Patel.

⁽³⁾The charge in respect of Term Loan shall be first charge and for soft loan, the charge shall be residual, but it shall rank *pari-passu* on the first charge basis with the term loan (irrespective of intervening charges, if any) after three years from the date of first disbursement under the soft loan or when the unit becomes ineligible for concessional funding under the scheme or in the event of default defined in the general conditions in respect of soft loan, whichever is earlier.

Note 3: Secured by hypothecation of stock and book debts and Documents of title to goods/ accepted Bill of entry.

* Further “Cash Credit and Export Packing Credit and Foreign Bill Purchase/ Foreign Bill Negotiated i.e. Fund based Facilities and Non- fund based facilities from Bank of India” all the herein mentioned facilities are collaterally secured by:

- Deposit of Company’s shares owned by shareholders/ joint shareholders other than guarantors.
- Assignment of two RDs with monthly instalment of ₹ 40,000/- for a period of 10 years in the name of Mrs. Smita S Patel and Mrs. Taruna P Patel.
- Assignment of RD with monthly installments of ₹ 1 lakh for a period of 5 years in the name of our Company
- Assignment of RD with monthly installments of ₹ 2 lakhs for a period of 3 years which is proposed.

Additionally secured by Equitable mortgage over Land and Building situated at Plot no. PAP-D-146 and PAP-D-147, MIDC, TTC Industrial area, Village Bonsary, Navi Mumbai- 400705 (admeasuring 300 sqm) in the name of our Company.

Furthermore, secured by guarantors Mrs. Smita S Patel, Mr. Sanjay J Patel, Mrs. Trauna P Patel and Mr. Piyush J Patel.

The aforesaid amounts sanctioned do not include sub-limit for amounts sanctioned towards Letters of Credit (“LC”), Financial Bank Guarantee (FBG)/ Performance Bank Guarantee (“PBG”)/ Non Fund Based (“NFB”) facilities. The details of the Non-Fund Based sanctions as per the above mentioned loan documentation is mentioned below:

Sr. No.	Name of Lender	Amount Sanctioned (₹ in lakhs)	Security
1.	CEL for booking of Forward contract- Bank of India *	34.00	Note 5
Total		34.00	

Note 4: Secured by hypothecation of equipments like computers which are acquired out of Bank’s Finance.

Note 5: For details refer (*) given above in relation to Bank of India

RESTRICTIVE / NEGATIVE COVENANTS

The above loan agreements includes various restrictive covenants in relation to certain actions to be undertaken by our Company and for which prior written approval of the Bank(s) is required. The major restrictive covenants (which require prior approval) are mentioned below: (some of these may be common across all banks, while some may be specific to a particular bank).



1. Our Company shall not formulate any scheme of amalgamation or merger or reconstruction.
2. Our Company shall not implement any scheme of expansion or diversification or capital expenditure except normal replacements indicate in Funds Flow Statement submitted.
3. Our Company shall not create or permit to subsist any mortgage, charge (whether floating or specific), pledge, lien or other security interest on any of our undertakings, properties or assets.
4. Our Company shall not effect any adverse changes in Company's capital structure.
5. Our Company shall not invest by way of share capital in or lent or advance funds to or place deposits with any other company/ concern.
6. Our Company shall not divert any funds to any purpose as the end use of the funds is restricted. Further, diversion of funds for any other purpose will be considered as default.
7. Our Company shall not declare dividends/ withdraw any amount in any form of salary/ remuneration/ incentive/ commission by the Promoters/ Directors in case of overdue with the Bank.
8. Our Company cannot change directors/ ownership/ promoters/ major shareholders without the written consent of the Bank.

In addition to the above, our company has availed vehicle loan amounting to ₹ 3.20 lakhs as on March 31, 2018 and the same is availed at an interest rate of 10.50 % p.a.

UNSECURED BORROWINGS OF OUR COMPANY:

Our Company has availed unsecured loans as on March 31, 2018 details of which are set out below:

(₹ in Lakhs)

Sr. No.	Nature of Borrowing	Amount
1.	Loan from Directors	240.28
2.	Banks and Financial Institutions	377.78
Total		618.06

For R A Maru & Associates.
Chartered Accountants
(Firm Registration No. 141914W)

Rumeet Anil Maru
Proprietor
Membership No: 166417

Place: Mumbai
Date: July 14, 2018



SECTION VII – LEGAL AND OTHER INFORMATION

OUTSTANDING LITIGATION AND MATERIAL DEVELOPMENTS

Except as stated in this section, there are no:

- A. *(i) criminal proceedings; (ii) actions by statutory or regulatory authorities; (iii) claims relating to direct and indirect taxes; or (iv) Material Litigation (as defined below); involving our Company, Directors, Promoters or Group Company. Our Board, in its meeting held on March 22, 2018 determined that, all outstanding litigations pertaining to our Company, its directors/ promoters/ group companies which are in the nature of criminal, statutory/ regulatory and taxation related which, exceeds 1% of the revenue of our Company as per the last audited financial statements are considered as material(“Material Litigation”).*
- B. *(i) litigation or legal actions, pending or taken, by any Ministry or department of the Government or a statutory authority against our Promoter during the last five years; (ii) pending proceedings initiated against our Company for economic offences; (iv) default and non-payment of statutory dues by our Company; (v) inquiries, inspections or investigations initiated or conducted under the Companies Act, 2013 or any previous companies law in the last five years against our Company; or (vi) material frauds committed against our Company in the last five years.*
- C. *(i) Outstanding Material Dues (as defined below) to creditors; or (ii) outstanding dues to small scale undertakings and other creditors.*

Our Board, in its meeting held on March 22, 2018, determined that all outstanding dues owed by Company to small scale undertaking and other creditors exceeding 1% of the revenue of our Company as per the last audited financial statements are considered as material(“Material Dues”). Details of outstanding dues to creditors (including micro and small enterprises as defined under the Micro, Small and Medium Enterprises Development Act, 2006) as required under the SEBI ICDR Regulations have been disclosed on our website at www.sakethexim.com.

Our Company, Directors, Promoter and Group Company are not Wilful Defaulters and there have been no violations of securities laws in the past or pending against them.

LITIGATION INVOLVING OUR COMPANY

CONTINGENT LIABILITIES OF OUR COMPANY

NIL

A. LITIGATION AGAINST OUR COMPANY

1. Criminal matters

NIL

2. Litigation Involving Actions by Statutory/Regulatory Authorities

NIL



3. Litigation involving Tax Liabilities

(i) Direct Tax Liabilities

NIL

(ii) Indirect Taxes Liabilities

NIL

4. Other Pending Litigations

NIL

B. LITIGATION FILED BY OUR COMPANY

1. Litigation Involving Criminal matters

NIL

2. Litigation Involving Actions by Statutory/Regulatory Authorities

NIL

3. Litigation involving Tax Liabilities

(i) Direct Tax Liabilities

Sr. No.	Type of Direct Tax	No. of Cases	Amount in dispute /demanded (₹ in lakhs)
1.	Income Tax (A.Y. 2014-15)	1	58.60*
Total		1	58.60

*Appeal dated January 25, 2018 filed by the Company before the Commissioner of Income Tax-Appeals, Mumbai inter-alia refuting the allegations made in the Assessment Order dated November 30, 2017 whereby the Income Tax Officer, Mumbai, demanded a sum of ₹ 58.60 lakhs payable by the Company for the A.Y. 2014-15. This matter is currently pending.

(ii) Indirect Taxes Liabilities

NIL

4. Other Pending Litigations

NIL

LITIGATION INVOLVING OUR DIRECTORS

A. LITIGATION AGAINST OUR DIRECTORS

1. Criminal matters

NIL



2. Litigation Involving Actions by Statutory/Regulatory Authorities

NIL

3. Litigation involving Tax Liabilities

(i) Direct Tax Liabilities

NIL

(ii) Indirect Taxes Liabilities

NIL

4. Other Pending Litigations

NIL

B. LITIGATION FILED BY OUR DIRECTORS

1. Litigation Involving Criminal matters

NIL

2. Litigation Involving Actions by Statutory/Regulatory Authorities

NIL

3. Litigation involving Tax Liabilities

(i) Direct Tax Liabilities

NIL

(ii) Indirect Taxes Liabilities

NIL

4. Other Pending Litigations

NIL

LITIGATION INVOLVING OUR PROMOTERS

A. LITIGATION AGAINST OUR PROMOTERS

1. Litigation Involving Criminal matters

NIL

2. Litigation Involving Actions by Statutory/Regulatory Authorities

NIL



3. Litigation involving Tax Liabilities

1. Direct Tax Liabilities

NIL

2. Indirect Taxes Liabilities

NIL

4. Other Pending Litigations

NIL

B. LITIGATION FILED BY OUR PROMOTERS

1. Litigation Involving Criminal matters

NIL

2. Litigation Involving Actions by Statutory/Regulatory Authorities

NIL

3. Litigation involving Tax Liabilities

(i) Direct Tax Liabilities

NIL

(ii) Indirect Taxes Liabilities

NIL

4. Other Pending Litigations

NIL

LITIGATION INVOLVING OUR GROUP COMPANY

A. LITIGATION AGAINST OUR GROUP COMPANY

1. Litigation involving Criminal matters

NIL

2. Litigation Involving Actions by Statutory/Regulatory Authorities

NIL



3. Litigation involving Tax Liabilities

(i) Direct Tax Liabilities

NIL

(ii) Indirect Taxes Liabilities

NIL

4. Other Pending Litigations

NIL

B. LITIGATION FILED BY OUR GROUP COMPANY

1. Criminal matters

NIL

2. Litigation Involving Actions by Statutory/Regulatory Authorities

NIL

3. Litigation involving Tax Liabilities

(i) Direct Tax Liabilities

NIL

(ii) Indirect Taxes Liabilities

NIL

4. Other Pending Litigations

NIL

There are no litigations or legal actions, pending or taken, by any Ministry or Department of the Government or a statutory authority against our Promoters during the last 5 (five) years.

There are no litigations or legal actions, pending or taken, by any Ministry or Department of the Government or a statutory authority against our Promoters during the last 5 (five) years.

Pending proceedings initiated against our Company for economic offences.

There are no pending proceedings initiated against our Company for economic offences.

Inquiries, investigations etc. instituted under the Companies Act, 2013 or any previous companies enactment in the last 5 (five) years against our Company.

There are no inquiries, investigations etc. instituted under the Companies Act or any previous companies enactment in the last 5 (five) years against our Company.



Material Fraud against our Company in the last 5 (five) years

There has been no material fraud committed against our Company in the last 5 (five) years.

Fines imposed or compounding of offences for default

There are no fines imposed or compounding of offences done in the last 5 (five) years immediately preceding the year of the Prospectus for the Company for default or outstanding defaults.

Non-Payment of Statutory Dues

There have been no defaults or outstanding defaults in the payment of statutory dues payable by the Company as of the date of the last audited financial statements of the Company.

Amounts owed to small scale undertakings and other creditors

As of March 31, 2018, our Company owes the following amounts to small scale undertakings, other creditors and material creditors:

Particulars	Number of creditors	Amount Involved (in ₹ Lakhs)
Micro, Small and Medium Enterprises	0	0.00
Material Creditors	3	334.19
Other Creditors	61	518.82
Creditors for expenses	48	65.07
Total	112	918.08

Details in relation to the amount owed by our Company to material creditors, small scale undertakings and other creditors as on March 31, 2018 are also available on www.sakethexim.com.

It is clarified that information provided on the website of our Company is not a part of this Prospectus and should not be deemed to be incorporated by reference. Anyone placing reliance on any other source of information, including our Company's website, would be doing so at its own risk.

Material developments occurring after last balance sheet date

Except as disclosed elsewhere in this Prospectus, there have been no material developments that have occurred after the Last Balance Sheet Date.



GOVERNMENT AND OTHER KEY APPROVALS

Our Company has received the necessary licenses, permissions and approvals from the Central and State Governments and other government agencies/regulatory authorities/certification bodies required to undertake the Issue or continue our business activities. In view of the approvals listed below, we can undertake the Issue and our current/proposed business activities and no further major approvals from any governmental/regulatory authority or any other entity are required to be undertaken, in respect of the Issue or to continue our business activities. It must, however, be distinctly understood that in granting the above approvals, the Government of India and other authorities do not take any responsibility for the financial soundness of the Company or for the correctness of any of the statements or any commitments made or opinions expressed in this behalf.

The main objects clause of the Memorandum of Association of the Company and the objects incidental, enable our Company to carry out its activities.

I. Approvals for the Issue

1. The Board of Directors have, pursuant to Section 62(1)(c) and other applicable provisions of the Companies Act 2013, by a resolution passed at its meeting held on March 20, 2018 authorized the Issue, subject to the approval of the shareholders and such other authorities as may be necessary.
2. The shareholders of our Company have, pursuant to Sections 62(1)(c) and other applicable provisions of the Companies Act, 2013, by a special resolution passed in the Extra-ordinary General Meeting held on March 22, 2018.
3. In-principle approval dated May 18, 2018 from the NSE for listing of the Equity Shares issued by our Company pursuant to the Issue.
4. Our Company's International Securities Identification Number ("ISIN") is INE869Y01010.

II. Approvals pertaining to Incorporation, name and constitution of our Company

1. Certificate of Incorporation dated June 16, 2010 issued by the Assistant Registrar of Companies, Mumbai ("RoC") in the name of "Saketh Exim Private Limited".
2. A fresh Certificate of Incorporation consequent upon change of name from "Saketh Exim Private Limited" to "Saketh Exim Limited" was issued on December 19, 2017 by the RoC.
3. The Corporate Identity Number (CIN) of the Company is U29253MH2010PLC204331.

III. GENERAL APPROVALS

1. Our Company has obtained Import Export License as a Merchant/ Manufacturer bearing No. 0319128918/0/36/00 for Export Period starting from September 27, 2017 to March 31, 2019 from the Directorate General of Foreign Trade, Government of India.
2. Our Company has obtained an Import Export Code bearing No. 0311015964 issued by the Foreign Trade Development Officer, Mumbai on June 14, 2011.
3. Our Company has obtained a Certificate of Recognition as "One Star Export House" bearing no. 030116000542 issued by the Additional Director General of Foreign Trade/ Development Commissioner (SEZ) on September 16, 2016 having validity up to September 15, 2021.
4. Our company has optioned a Certificate Bearing No. 85-947-6401 declaring the company a part of the Dun & Bradstreet Global Database issued by the Dun and Bradstreet Corporation, USA on November 28, 2016.



5. Our Company has acquired Membership cum Registration bearing no. FIEO/WR/1539/2016-17 with the Federation of Indian Export Organisation on April 27, 2018 having validity till March 31, 2019.
6. Our Company has obtained a Certificate of Compliance of Quality Standards ISO 9001:2015 bearing No. 10Q/SEN/08003 for its Quality Management Systems from the SGI on August 3, 2016 having validity till August 2, 2019.
7. Our Company has obtained a Certificate of Compliance of UL Safety Standards bearing No. 20130628-EX16250 for its products from the Director of North American Certification Programs on June 28, 2013.
8. Our Company has obtained Certificate of Compliance of FM Approved standards bearing No. 0003056409 for its products from the AVP, Manager-Fire Protection of FM Approvals on April 25, 2016.
9. Our Company has obtained Certificate of Compliance of FM Approved standards bearing No. 0003060652 from the AVP, Manager-Fire Protection of FM Approvals on March 23, 2017.
10. Our Company has obtained a Certificate of Compliance of UL Safety Standards bearing No. HLXS.EX27325 for its products from the Director of North American Certification Programs.

IV. TAX RELATED APPROVALS

A. Approvals obtained by the Company

Sr. No.	Description	Authority	Registration Number	Date of Issue	Date of Expiry
1.	Tax Deduction Account Number (TAN)	Income Tax Department, Government of India	MUMS94236C	April 30, 2011	Valid until cancelled
2.	Permanent Account Number (PAN)	Income Tax Department, Government of India	AAPCS4498C	March 18, 2011	Valid until cancelled
3.	Certificate of Provisional Registration under Central Goods and Services Tax Act, 2017	Government of India and Government of Maharashtra	27AAPCS4498C1ZV	June 28, 2017	Valid until cancelled
4.	Certificate of Enrolment under the Maharashtra State Tax on Professions, Trades, Callings and Employments Act, 1975	Sales Tax Department, Maharashtra	99553158766P	January 16, 2018	Valid until cancelled
5.	Certificate of Registration under the Maharashtra State Tax on Professions, Trades, Callings and Employments Act,	Profession Tax Officer, Mumbai	27910832144P	March 21, 2013	Valid until cancelled



Sr. No.	Description	Authority	Registration Number	Date of Issue	Date of Expiry
	1975.*				
6.	Value Added Tax Registration Certificate under the Maharashtra Value Added Tax Act, 2002.	Assistant Commissioner of Sales Tax, Mumbai.	27910832144V	May 4, 2011	Valid until cancelled
7.	Central Sales Tax Registration	Assistant Commissioner of Sales Tax, Mumbai	27910832144C	May 4, 2011	Valid until cancelled

**This Certificate reflects the Company's old address situated in Wadala and the Company is in the process of making an application with the respective authority to reflect the change in Company's registered address as PAP-D-146 & PAP-D-147, Thane, Turbhe, Navi Mumbai- 400709.*



V. BUSINESS RELATED APPROVALS

Sr. No.	Property Description	Registration/ Approval/ Certificate Number	Issuing Authority	Date of Issue	Date of Expiry
1.	PAP-D-146 & PAP-D-147, Thane, Turbhe. Navi Mumbai-400709	Grant of the land as an Industrial Unit	Area Manager, MIDC Mahape.	January 05, 2011	Valid Until Cancelled.
		Udyog Adhaar Memorandum bearing No. 27-021-11-02718	Ministry of Micro, Small and Medium Industries.	December 15, 2011	Valid Until Cancelled.
2.	Plot No. 3, Survey No. 62, Hissa 18(1) (2), N.H. No. 8, Ganesh Industrial Estate, Sativali, Vasai, Palghar.	Udyog Adhaar Memorandum bearing No. MH17A0002751	Ministry of Micro, Small and Medium Industries.	June 15, 2016	Valid Until Cancelled.
		Consent to Operate under the Water (Prevention and Control of Pollution) Act, 1974 Air (Prevention and Control of Pollution) Act, 1981 and Hazardous Waste Management Rules 1989.	Maharashtra Pollution Control Board	December 27, 2016.	July 30, 2021
3.	Unit 3, APL House, Tungreshwar Industrial Estate, S. No. 1, Hissa No. 8, Sativali, Vasai-401208.	Udyog Adhaar Memorandum bearing No. MH17A0015810	Ministry of Micro, Small and Medium Industries.	June 16, 2010	Valid Until Cancelled
		Consent to Operate under the Water (Prevention and Control of Pollution) Act, 1974 Air (Prevention and Control of Pollution) Act, 1981 and Hazardous Waste Management Rules 1989.	Maharashtra Pollution Control Board	May 04, 2018	July 30, 2018
		Consent to Establish under the Water (Prevention and Control of Pollution) Act, 1974 Air (Prevention and Control of Pollution) Act, 1981 and Hazardous Waste Management Rules 1989.	Maharashtra Pollution Control Board	December 08, 2017	December 07, 2022



Sr. No.	Property Description	Registration/ Approval/ Certificate Number	Issuing Authority	Date of Issue	Date of Expiry
4.	Unit No. 1/B, Badrinath, Ground Floor, Tungareshwar Industrial Complex, Sativali, Vasai – 401208.	Factory License bearing Registration No. 1290025991080841	Inspector of Industrial health and Safety	October 15, 2017	October 14, 2018
		Consent to Operate under the Water (Prevention and Control of Pollution) Act, 1974 Air (Prevention and Control of Pollution) Act, 1981 and Hazardous Waste Management Rules 1989 bearing No. SRO-THANEII/CONSENT/O/1711000587	Maharashtra Pollution Control Board	November 16, 2017	December 31, 2020

VI. APPROVALS RELATING TO INTELLECTUAL PROPERTY

Sr. No.	Particulars of Marks	Word/ Label Mark	Applicant	Application No.	Date of Filing	Class	Status
1.	Trademark (Device)	TEMBO	Saketh Exim Private Limited	2102325	February 18, 2011	16	Registered
2.	Trademark (Device)		Saketh Exim Private Limited	2268470	January 18, 2012	6	Registered
3.	Trademark (Device)		Saketh Exim Private Limited	2642287	December 13, 2013	6	Objected
4.	Trademark (Device)		Saketh Exim Private Limited	3717194	January 02, 2018	6	Objected

VIII. PENDING APPROVALS

- 1) Application for Factory License is made to the Chief Inspector of Factories in respect of the factory situated at Unit 3, APL House, Tungareshwar Industrial Estate, S. No. 1, Hissa No. 8, Sativali, Vasai- 401208.
- 2) The company has made an application for Registration under Section 7 of the Contract Labour (Regulation and Abolition) Act, 1970 on December 15, 2017.

IX. APPLICATIONS YET TO BE MADE

- 1) The Company is in the process of making an application to obtain the Certificate of Registration under the Employees Provident Fund and Miscellaneous Provisions Act, 1952; and



- 2) The Company is in the process of making an application to obtain the Certificate of Registration under the Employee State Insurance Act, 1948.



SECTION VIII – OTHER REGULATORY AND STATUTORY DISCLOSURES

Authority for the Issue

Our Board of Directors have vide resolution dated March 20, 2018 authorized the Issue, subject to the approval by the shareholders of our Company under Section 62(1)(c) of the Companies Act, 2013.

The shareholders have authorized the Issue, by passing a Special Resolution at the Extra-Ordinary General Meeting held with shorter notice on March 22, 2018, in accordance with the provisions of Section 62(1)(c) of the Companies Act, 2013.

The Company has obtained approval from NSE vide letter dated May 18, 2018 to use the name of NSE in this Offer Document for listing of equity shares on the EMERGE platform of the NSE. NSE is the designated stock exchange.

Prohibition by SEBI, the RBI or Governmental Authorities

We confirm that there is no prohibition on our Company, its Directors, Promoters and entities forming part of our Promoter Group from accessing the capital market or operating in the capital markets under any order or direction passed by SEBI or any other regulatory or governmental authority.

Neither our Company, our Promoters, relatives of Promoters (as defined under Companies Act, 2013), our Directors, nor our Group Companies have been identified as wilful defaulters by the RBI or other authorities.

The listing of any securities of our Company has never been refused at any time by any of the stock exchanges in India.

Association with Securities Market

We confirm that none of our Directors are associated with the Securities Market in any manner and no action has been initiated against these entities by SEBI at any time except as stated under the chapters titled “*Risk Factors*”, “*Our Promoters and Promoter Group*”, “*Our Group Company*” and “*Outstanding Litigations and Material Developments*” beginning on page nos. 15, 142, 146 and 191 respectively, of this Prospectus.

Eligibility for the Issue

Our Company is an “Unlisted Issuer” in terms of the SEBI (ICDR) Regulation; and this Issue is an “Initial Public Offer” in terms of the SEBI (ICDR) Regulations.

This Issue is being made in terms of Regulation 106 (M) (1) of Chapter XB of the SEBI (ICDR) Regulations, 2009, as amended from time to time, whereby, an issuer whose post Issue face value capital does not exceed ten crores rupees, shall issue shares to the public and propose to list the same on the Small and Medium Enterprise Exchange (“SME Exchange”, in this case being the EMERGE Platform of NSE).

We confirm that:

- a) In accordance with Regulation 106 (P) of the SEBI (ICDR) Regulations, this issue has been hundred percent underwritten and that the Lead Manager to the Issue has underwritten more than 15% of the total Issue Size. For further details pertaining to the said underwriting please see “*General Information- Underwriting*” on page no. 57 of this Prospectus.
- b) In accordance with Regulation 106(R) of the SEBI (ICDR) Regulations, we shall ensure that the total number of proposed allottees in the Issue is greater than or equal to fifty, otherwise, the entire application money will be refunded / unblocked forthwith. If such money is not repaid / unblocked, then our Company and every officer in



default shall be liable to repay / unblock such application money, with interest as prescribed under SEBI (ICDR) Regulations, the Companies Act, 2013 and applicable law. Further, in accordance with Section 40 of the Companies Act, 2013, the Company and each officer in default may be punishable with fine and/or imprisonment in such a case.

- c) In accordance with Regulation 106(O) the SEBI (ICDR) Regulation, we have not filed any Offer Document with SEBI nor has SEBI issued any observations on our Offer Document. Also, we shall ensure that our Lead Manager submits the copy of Prospectus along with a Due Diligence Certificate including additional confirmations as required to SEBI at the time of filing the Prospectus with Stock Exchange and the Registrar of Companies.
- d) In accordance with Regulation 106(V) of the SEBI (ICDR) Regulations, we have entered into an agreement with the Lead Manager and the Market Maker to ensure compulsory Market Making for a minimum period of three years from the date of listing of equity shares offered in this Issue. For further details of the arrangement of Market Making, please see “General Information- Details of the Market Making Arrangements for this Issue” on page no. 58 of this Prospectus.

We further confirm that we shall be complying with all other requirements as laid down for such issue under Chapter XB of SEBI (ICDR) Regulations, as amended from time to time and subsequent circulars and guidelines issued by SEBI and the Stock Exchange.

- e) Our Company has been incorporated under the Companies Act 1956, in India.
- f) The Net worth (excluding revaluation reserves) of our Company is positive as per the latest audited financial results and we have a positive cash accruals (earnings before depreciation and tax) from operations for atleast 2 financial years.

(₹ in lakhs)

Particulars	Fiscal 2018	Fiscal 2017	Fiscal 2016
Net Worth (excluding revaluation reserves)	732.23	497.53	401.98
Earnings before Depreciation & Tax	213.00	200.91	150.84

- g) Our Company has track record of at least 3 years.
- h) Our Company has not been referred to the Board for Industrial and Financial Reconstruction (BIFR).
- i) Our Company has not been in defaults in respect of payment of interest and/or principal to the debenture/bond/fixed deposit holders, banks, FIs by the applicant, promoters/promoting company(ies), group companies, companies promoted by the promoters/promoting company(ies) during the past three years.
- j) There is no winding up petition against the company, which has been admitted by a Court of competent jurisdiction.
- k) There has been no material regulatory or disciplinary action by a stock exchange or regulatory authority in the past three years against our company.
- l) As on the date of this Prospectus, our Company has a paid up capital of ₹ 390.00 lakhs (₹ 3.90 crores) and the Post Issue Capital will be of ₹ 502.30 lakhs (₹ 5.02 crores).
- m) Our company shall mandatorily facilitate trading in demat securities and enter into an agreement with both the depositories.
- n) We have a website: www.sakethexim.com



Disclosure

The Issuer, the Directors, the Selling Shareholder, our Promoters, Promoter Group and the members of our Group Companies have confirmed that they have not been identified as wilful defaulters by the RBI or any other Governmental Authority.

Disclaimer Clause of SEBI

IT IS TO BE DISTINCTLY UNDERSTOOD THAT SUBMISSION OF OFFER DOCUMENT TO SECURITIES AND EXCHANGE BOARD OF INDIA (SEBI) SHOULD NOT IN ANY WAY BE DEEMED OR CONSTRUED THAT THE SAME HAS BEEN CLEARED OR APPROVED BY SEBI. SEBI DOES NOT TAKE ANY RESPONSIBILITY EITHER FOR THE FINANCIAL SOUNDNESS OF ANY SCHEME OR THE PROJECT FOR WHICH THE ISSUE IS PROPOSED TO BE MADE OR FOR THE CORRECTNESS OF THE STATEMENTS MADE OR OPINIONS EXPRESSED IN THE OFFER DOCUMENT. THE LEAD MERCHANT BANKER, ARYAMAN FINANCIAL SERVICES LIMITED, HAVE CERTIFIED THAT THE DISCLOSURES MADE IN THE OFFER DOCUMENT ARE GENERALLY ADEQUATE AND ARE IN CONFORMITY WITH SEBI (ISSUE OF CAPITAL AND DISCLOSURE REQUIREMENTS) REGULATIONS, 2009 IN FORCE FOR THE TIME BEING. THIS REQUIREMENT IS TO FACILITATE INVESTORS TO TAKE AN INFORMED DECISION FOR MAKING AN INVESTMENT IN THE PROPOSED ISSUE.

IT SHOULD ALSO BE CLEARLY UNDERSTOOD THAT WHILE THE COMPANY AND THE SELLING SHAREHOLDER ARE PRIMARILY RESPONSIBLE FOR THE CORRECTNESS, ADEQUACY AND DISCLOSURE OF ALL RELEVANT INFORMATION IN THE PROSPECTUS, THE LEAD MERCHANT BANKER ARE EXPECTED TO EXERCISE DUE DILIGENCE TO ENSURE THAT THE COMPANY AND THE SELLING SHAREHOLDER DISCHARGES ITS RESPONSIBILITY ADEQUATELY IN THIS BEHALF AND TOWARDS THIS PURPOSE, THE LEAD MERCHANT BANKER, ARYAMAN FINANCIAL SERVICES LIMITED HAVE FURNISHED TO SEBI, A DUE DILIGENCE CERTIFICATE DATED JULY 23, 2018, WHICH READS AS FOLLOWS.

WE, THE LEAD MANAGER TO THE ABOVE MENTIONED ISSUE, STATE AND CONFIRM AS FOLLOWS:

- 1. WE HAVE EXAMINED VARIOUS DOCUMENTS INCLUDING THOSE RELATING TO LITIGATION LIKE COMMERCIAL DISPUTES, PATENT DISPUTES, DISPUTES WITH COLLABORATORS, ETC. AND OTHER MATERIAL IN CONNECTION WITH THE FINALISATION OF THE PROSPECTUS PERTAINING TO THE SAID ISSUE;**
- 2. ON THE BASIS OF SUCH EXAMINATION AND THE DISCUSSIONS WITH THE COMPANY, ITS DIRECTORS AND OTHER OFFICERS, OTHER AGENCIES, AND INDEPENDENT VERIFICATION OF THE STATEMENTS CONCERNING THE OBJECTS OF THE ISSUE, PRICE JUSTIFICATION AND THE CONTENTS OF THE DOCUMENTS AND OTHER PAPERS FURNISHED BY THE COMPANY, WE CONFIRM THAT:**
 - A. THE PROSPECTUS FILED WITH THE BOARD IS IN CONFORMITY WITH THE DOCUMENTS, MATERIALS AND PAPERS RELEVANT TO THE ISSUE;**
 - B. ALL THE LEGAL REQUIREMENTS RELATING TO THE ISSUE AS ALSO THE REGULATIONS GUIDELINES, INSTRUCTIONS, ETC. FRAMED / ISSUED BY THE BOARD, THE CENTRAL GOVERNMENT AND ANY OTHER COMPETENT AUTHORITY IN THIS BEHALF HAVE BEEN DULY COMPLIED WITH; AND**
 - C. THE DISCLOSURES MADE IN THE PROSPECTUS ARE TRUE, FAIR AND ADEQUATE TO ENABLE THE INVESTORS TO MAKE A WELL INFORMED DECISION AS TO THE INVESTMENT IN THE PROPOSED ISSUE AND SUCH DISCLOSURES ARE IN ACCORDANCE WITH THE REQUIREMENTS OF THE COMPANIES ACT, 1956, THE COMPANIES ACT, 2013 (TO THE EXTENT NOTIFIED), THE SECURITIES AND EXCHANGE**



BOARD OF INDIA (ISSUE OF CAPITAL AND DISCLOSURE REQUIREMENTS) REGULATIONS, 2009 AND OTHER APPLICABLE LEGAL REQUIREMENTS.

- 3. WE CONFIRM THAT BESIDES OURSELVES, ALL THE INTERMEDIARIES NAMED IN THE PROSPECTUS ARE REGISTERED WITH THE BOARD AND THAT TILL DATE SUCH REGISTRATION IS VALID.**
- 4. WE HAVE SATISFIED OURSELVES ABOUT THE CAPABILITY OF THE UNDERWRITERS TO FULFIL THEIR UNDERWRITING COMMITMENTS.**
- 5. WE CERTIFY THAT WRITTEN CONSENT FROM PROMOTERS HAS BEEN OBTAINED FOR INCLUSION OF THEIR SPECIFIED SECURITIES AS PART OF PROMOTERS CONTRIBUTION SUBJECT TO LOCK-IN AND THE SPECIFIED SECURITIES PROPOSED TO FORM PART OF PROMOTERS CONTRIBUTION SUBJECT TO LOCK-IN SHALL NOT BE DISPOSED / SOLD / TRANSFERRED BY THE PROMOTERS DURING THE PERIOD STARTING FROM THE DATE OF FILING OF THE PROSPECTUS WITH THE BOARD TILL THE DATE OF COMMENCEMENT OF LOCK-IN PERIOD AS STATED IN THE PROSPECTUS.**
- 6. WE CERTIFY THAT REGULATION 33 OF THE SECURITIES AND EXCHANGE BOARD OF INDIA (ISSUE OF CAPITAL AND DISCLOSURE REQUIREMENTS) REGULATIONS, 2009, WHICH RELATES TO SPECIFIED SECURITIES INELIGIBLE FOR COMPUTATION OF PROMOTERS CONTRIBUTION, HAS BEEN DULY COMPLIED WITH AND APPROPRIATE DISCLOSURES AS TO COMPLIANCE WITH THE SAID REGULATION HAVE BEEN MADE IN THE PROSPECTUS.**
- 7. WE UNDERTAKE THAT SUB-REGULATION (4) OF REGULATION 32 AND CLAUSE (C) AND (D) OF SUB-REGULATION (2) OF REGULATION 8 OF THE SECURITIES AND EXCHANGE BOARD OF INDIA (ISSUE OF CAPITAL AND DISCLOSURE REQUIREMENTS) REGULATIONS, 2009 SHALL BE COMPLIED WITH. WE CONFIRM THAT ARRANGEMENTS HAVE BEEN MADE TO ENSURE THAT PROMOTERS CONTRIBUTION SHALL BE RECEIVED AT LEAST ONE DAY BEFORE THE OPENING OF THE OFFER. WE UNDERTAKE THAT AUDITOR'S CERTIFICATE TO THIS EFFECT SHALL BE DULY SUBMITTED TO THE BOARD. WE FURTHER CONFIRM THAT ARRANGEMENTS HAVE BEEN MADE TO ENSURE THAT PROMOTERS' CONTRIBUTION SHALL BE KEPT IN AN ESCROW ACCOUNT WITH A SCHEDULED COMMERCIAL BANK AND SHALL BE RELEASED TO THE COMPANY ALONG WITH THE PROCEEDS OF THE PUBLIC OFFER. – NOT APPLICABLE**
- 8. WE CERTIFY THAT THE PROPOSED ACTIVITIES OF THE COMPANY FOR WHICH THE FUNDS ARE BEING RAISED IN THE PRESENT ISSUE FALL WITHIN THE "MAIN OBJECTS" LISTED IN THE OBJECT CLAUSE OF THE MEMORANDUM OF ASSOCIATION OR OTHER CHARTER OF THE COMPANY AND THAT THE ACTIVITIES WHICH HAVE BEEN CARRIED OUT UNTIL NOW ARE VALID IN TERMS OF THE OBJECT CLAUSE OF ITS MEMORANDUM OF ASSOCIATION.**
- 9. WE CONFIRM THAT NECESSARY ARRANGEMENTS HAVE BEEN MADE TO ENSURE THAT THE MONEYS RECEIVED PURSUANT TO THE ISSUE ARE KEPT IN A SEPARATE BANK ACCOUNT AS PER THE PROVISIONS OF SUB-SECTION (3) OF SECTION 73 OF THE COMPANIES ACT, 1956 (SECTION 40 OF COMPANIES ACT, 2013) AND THAT SUCH MONEYS SHALL BE RELEASED BY THE SAID BANK ONLY AFTER PERMISSION IS OBTAINED FROM ALL THE STOCK EXCHANGES MENTIONED IN THE PROSPECTUS. WE FURTHER CONFIRM THAT THE AGREEMENT ENTERED INTO BETWEEN THE BANKERS TO THE ISSUE AND THE COMPANY SPECIFICALLY CONTAINS THIS CONDITION. – NOTED FOR COMPLIANCE. ALL MONIES RECEIVED OUT OF THE ISSUE SHALL BE CREDITED/ TRANSFERRED TO A**



SEPARATE BANK ACCOUNT AS REFERRED TO IN SUB-SECTION (3) OF SECTION 40 OF THE COMPANIES ACT, 2013.

- 10. WE CERTIFY THAT A DISCLOSURE HAS BEEN MADE IN THE PROSPECTUS THAT THE INVESTORS SHALL BE GIVEN AN OPTION TO GET THE SHARES IN DEMAT OR PHYSICAL MODE. – NOT APPLICABLE. UNDER SECTION 29 OF THE COMPANIES ACT, 2013, THE EQUITY SHARES ARE TO BE ISSUED IN DEMAT ONLY.**
- 11. WE CERTIFY THAT ALL THE APPLICABLE DISCLOSURES MANDATED IN THE SECURITIES AND EXCHANGE BOARD OF INDIA (ISSUE OF CAPITAL AND DISCLOSURE REQUIREMENTS) REGULATIONS, 2009 HAVE BEEN MADE IN ADDITION TO DISCLOSURES WHICH, IN OUR VIEW, ARE FAIR AND ADEQUATE TO ENABLE THE INVESTOR TO MAKE A WELL INFORMED DECISION.**
- 12. WE CERTIFY THAT THE FOLLOWING DISCLOSURES HAVE BEEN MADE IN THE PROSPECTUS:**
 - A. AN UNDERTAKING FROM THE COMPANY THAT AT ANY GIVEN TIME, THERE SHALL BE ONLY ONE DENOMINATION FOR THE EQUITY SHARES OF THE COMPANY, AND**
 - B. AN UNDERTAKING FROM THE COMPANY THAT IT SHALL COMPLY WITH SUCH DISCLOSURE AND ACCOUNTING NORMS SPECIFIED BY THE BOARD FROM TIME TO TIME.**
- 13. WE UNDERTAKE TO COMPLY WITH THE REGULATIONS PERTAINING TO ADVERTISEMENT IN TERMS OF THE SECURITIES AND EXCHANGE BOARD OF INDIA (ISSUE OF CAPITAL AND DISCLOSURE REQUIREMENTS) REGULATIONS, 2009 WHILE MAKING THE ISSUE – NOTED FOR COMPLIANCE.**
- 14. WE ENCLOSE A NOTE EXPLAINING HOW THE PROCESS OF DUE DILIGENCE HAS BEEN EXERCISED BY US IN VIEW OF THE NATURE OF CURRENT BUSINESS BACKGROUND OF THE COMPANY, SITUATION AT WHICH THE PROPOSED BUSINESS STANDS, THE RISK FACTORS, PROMOTERS EXPERIENCE, ETC.**
- 15. WE ENCLOSE A CHECKLIST CONFIRMING REGULATION-WISE COMPLIANCE WITH THE APPLICABLE PROVISIONS OF THE SECURITIES AND EXCHANGE BOARD OF INDIA (ISSUE OF CAPITAL AND DISCLOSURE REQUIREMENTS) REGULATIONS, 2009, CONTAINING DETAILS SUCH AS THE REGULATION NUMBER, ITS TEXT, THE STATUS OF COMPLIANCE, PAGE NUMBER OF THE PROSPECTUS WHERE THE REGULATION HAS BEEN COMPLIED WITH AND OUR COMMENTS, IF ANY.**
- 16. WE ENCLOSE STATEMENT ON PRICE INFORMATION OF PAST ISSUES HANDLED BY MERCHANT BANKER AS PER FORMAT SPECIFIED BY SEBI THROUGH CIRCULAR (PLEASE SEE “ANNEXURE A” FOR FURTHER DETAILS).**
- 17. WE CERTIFY THAT PROFITS FROM RELATED PARTY TRANSACTIONS HAVE ARISEN FROM LEGITIMATE BUSINESS TRANSACTIONS – COMPLIED WITH TO THE EXTENT OF THE RELATED PARTY TRANSACTIONS CERTIFIED BY PEER REVIEW AUDITORS PURSUANT TO ITS REPORT DATED JULY 14, 2018**

THE FILING OF THIS OFFER DOCUMENT DOES NOT, HOWEVER, ABSOLVE OUR COMPANY FROM ANY LIABILITIES UNDER SECTION 63 OR SECTION 68 OF THE COMPANIES ACT, 1956 (SECTION 34 OR SECTION 36 OF THE COMPANIES ACT, 2013) OR FROM THE REQUIREMENT OF OBTAINING SUCH STATUTORY AND/OR OTHER CLEARANCES AS MAY BE REQUIRED FOR THE PURPOSE OF THE PROPOSED ISSUE. SEBI FURTHER RESERVES THE RIGHT TO TAKE UP AT



ANY POINT OF TIME, WITH THE LEAD MERCHANT BANKERS ANY IRREGULARITIES OR LAPSES IN THE OFFER DOCUMENT.

Note:

All legal requirements pertaining to the Issue will be complied with at the time of registration of the Prospectus with the RoC in terms of section 26 and 30 of the Companies Act, 2013.

ADDITIONAL CONFIRMATIONS/ CERTIFICATIONS TO BE GIVEN BY MERCHANT BANKER IN DUE DILIGENCE CERTIFICATE TO BE GIVEN ALONG WITH OFFER DOCUMENT REGARDING SME EXCHANGE

- 1. WE CONFIRM THAT NONE OF THE INTERMEDIARIES NAMED IN THE OFFER DOCUMENT HAVE BEEN DEBARRED FROM FUNCTIONING BY ANY REGULATORY AUTHORITY.**
- 2. WE CONFIRM THAT ALL THE MATERIAL DISCLOSURES IN RESPECT OF THE COMPANY HAVE BEEN MADE IN PROSPECTUS AND CERTIFY THAT ANY MATERIAL DEVELOPMENT IN THE COMPANY OR RELATING TO THE ISSUE UP TO THE COMMENCEMENT OF LISTING AND TRADING OF THE SPECIFIED SECURITIES OFFERED THROUGH THIS ISSUE SHALL BE INFORMED THROUGH PUBLIC NOTICES/ ADVERTISEMENTS IN ALL THOSE NEWSPAPERS IN WHICH PRE-ISSUE ADVERTISEMENT AND ADVERTISEMENT FOR OPENING OR CLOSURE OF THE ISSUE HAVE BEEN GIVEN.**
- 3. WE CONFIRM THAT THE ABRIDGED PROSPECTUS CONTAINS ALL THE DISCLOSURES AS SPECIFIED IN THE SECURITIES AND EXCHANGE BOARD OF INDIA (ISSUE OF CAPITAL AND DISCLOSURE REQUIREMENTS) REGULATIONS, 2009. – NOTED FOR COMPLIANCE**
- 4. WE CONFIRM THAT AGREEMENTS HAVE BEEN ENTERED INTO WITH THE DEPOSITORIES FOR DEMATERIALISATION OF THE SPECIFIED SECURITIES OF THE COMPANY.**
- 5. WE CERTIFY THAT AS PER THE REQUIREMENTS OF FIRST PROVISOR TO SUB-REGULATION (4) OF REGULATION 32 OF SECURITIES AND EXCHANGE BOARD OF INDIA (ISSUE OF CAPITAL AND DISCLOSURE REQUIREMENTS) REGULATIONS, 2009; CASH FLOW STATEMENT HAS BEEN PREPARED AND DISCLOSED IN THE PROSPECTUS.**
- 6. WE CONFIRM THAT UNDERWRITING AND MARKET MAKING ARRANGEMENTS AS PER REQUIREMENTS OF REGULATION 106P AND 106V OF THE SECURITIES AND EXCHANGE BOARD OF INDIA (ISSUE OF CAPITAL AND DISCLOSURE REQUIREMENTS) REGULATIONS, 2009 HAVE BEEN MADE.**

Disclaimer from our Company, the Selling Shareholders and the Lead Manager

Our Company, its Directors, the Selling Shareholders and the Lead Manager accept no responsibility for statements made otherwise than those contained in this Prospectus or, in case of the Company, in any advertisements or any other material issued by or at our Company's instance and anyone placing reliance on any other source of information would be doing so at his or her own risk.



CAUTION

The Lead Manager accepts no responsibility, save to the limited extent as provided in the MoU for Issue Management entered into among the Lead Manager, our Company and Selling Shareholder dated March 22, 2018 and addendum dated June 12, 2018, the Underwriting Agreement dated March 22, 2018 and addendum dated June 12, 2018 entered into among the Underwriter, our Company and Selling Shareholder and the Market Making Agreement dated March 22, 2018 and addendum dated June 12, 2018 entered into among the Market Maker, Lead Manager and our Company.

All information shall be made available by us and the Lead Manager to the public and investors at large and no selective or additional information would be available for a section of the investors in any manner whatsoever including at road show presentations, in research or sales reports or at collection centres or elsewhere.

Note:

Investors who apply in the Issue will be required to confirm and will be deemed to have represented to our Company, the Selling Shareholder, the Underwriter and their respective directors, officers, agents, affiliates and representatives that they are eligible under all applicable laws, rules, regulations, guidelines and approvals to acquire Equity Shares of our Company and will not offer, sell, pledge or transfer the Equity Shares of our Company to any person who is not eligible under applicable laws, rules, regulations, guidelines and approvals to acquire Equity Shares of our Company. Our Company, the Underwriter and their respective directors, officers, agents, affiliates and representatives accept no responsibility or liability for advising any investor on whether such investor is eligible to acquire Equity Shares of our Company.

Disclaimer in respect of Jurisdiction

This Issue is being made in India to persons resident in India including Indian nationals resident in India (who are not minors, except through their legal guardian), Hindu Undivided Families (HUFs), companies, corporate bodies and societies registered under the applicable laws in India and authorized to invest in shares, Mutual Funds, Indian financial institutions, commercial banks, regional rural banks, co-operative banks (subject to RBI permission), Trusts registered under the Societies Registration Act, 1860, as amended from time to time, or any other trust law and who are authorised under their constitution to hold and invest in shares, permitted insurance companies and pension funds and to non-residents including NRIs and FIIs. The Prospectus does not, however, constitute an offer to sell or an invitation to subscribe to Equity Shares offered hereby in any other jurisdiction to any person to whom it is unlawful to make an issue or invitation in such jurisdiction. Any person into whose possession the Prospectus comes is required to inform himself or herself about, and to observe, any such restrictions. Any dispute arising out of this Issue will be subject to the jurisdiction of appropriate court(s) in Mumbai only.

No action has been or will be taken to permit a public offering in any jurisdiction where action would be required for that purpose. Accordingly, the Equity Shares represented thereby may not be offered or sold, directly or indirectly, and the Prospectus may not be distributed, in any jurisdiction, except in accordance with the legal requirements applicable in such jurisdiction. Neither the delivery of the Prospectus nor any sale hereunder shall, under any circumstances, create any implication that there has been any change in the affairs of our Company since the date hereof or that the information contained herein is correct as of any time subsequent to this date

Disclaimer Clause of the EMERGE Platform of NSE

As required, a copy of this Offer Document has been submitted to National Stock Exchange of India Limited (hereinafter referred to as NSE). NSE has given vide its letter Ref.: NSE/LIST/81 dated May 18, 2018 permission to the Issuer to use the Exchange's name in this Offer Document as one of the stock exchanges on which this Issuer's securities are proposed to be listed. The Exchange has scrutinized this draft offer document for its limited internal purpose of deciding on the matter of granting the aforesaid permission to this Issuer. It is to be distinctly understood that the aforesaid permission given by NSE should not in any way be deemed or construed that the offer document has been cleared or approved by NSE; nor does it in any manner warrant, certify or endorse the correctness or



completeness of any of the contents of this offer document; nor does it warrant that this Issuer's securities will be listed or will continue to be listed on the Exchange; nor does it take any responsibility for the financial or other soundness of this Issuer, its promoters, its management or any scheme or project of this Issuer.

Every person who desires to apply for or otherwise acquire any securities of this Issuer may do so pursuant to independent inquiry, investigation and analysis and shall not have any claim against the Exchange whatsoever by reason of any loss which may be suffered by such person consequent to or in connection with such subscription /acquisition whether by reason of anything stated or omitted to be stated herein or any other reason whatsoever."

Disclaimer Clause under Rule 144A of the U.S. Securities Act

The Equity Shares have not been and will not be registered under the U.S. Securities Act 1933, as amended (the "Securities Act") or any state securities laws in the United States and may not be offered or sold within the United States or to, or for the account or benefit of, "U.S. persons" (as defined in Regulation S of the Securities Act), except pursuant to an exemption from, or in a transaction not subject to, the registration requirements of the Securities Act. Accordingly, the Equity Shares will be offered and sold (i) in the United States only to "qualified institutional buyers", as defined in Rule 144A of the Securities Act, and (ii) outside the United States in offshore transactions in reliance on Regulation S under the Securities Act and in compliance with the applicable laws of the jurisdiction where those offers and sales occur.

The Equity Shares have not been and will not be registered, listed or otherwise qualified in any other jurisdiction outside India and may not be offered or sold, and Applicants may not be made by persons in any such jurisdiction, except in compliance with the applicable laws of such jurisdiction.

Filing

The Prospectus shall not be filed with SEBI, nor will SEBI issue any observation on the offer document in term of Reg. 106 (O) (1). However, a copy of the Prospectus shall be filed with SEBI at the Corporation Finance Department, Plot no-C4-A, 'G' Block, Bandra Kurla Complex, Bandra (East), Mumbai -400051

A copy of the Prospectus, along with the documents required to be filed under Section 26 of the Companies Act, 2013 will be delivered to the RoC situated at Everest, 5th Floor, Marine Drive, Mumbai - 400002.

Listing

Application shall be made to EMERGE Platform of NSE for obtaining permission for listing of the Equity Shares being offered and sold in the Issue on its EMERGE Platform after the allotment in the Issue. NSE is the Designated Stock Exchange, with which the Basis of Allotment will be finalized for the Issue.

If the permission to deal in and for an official quotation of the Equity Shares on the SME Platform is not granted by NSE, our Company and the Selling Shareholder shall forthwith repay, without interest, all moneys received from the applicants in pursuance of the Prospectus. The allotment letters shall be issued or application money shall be refunded / unblocked within eight days from the closure of the Issue or such lesser time as may be specified by Securities and Exchange Board or else the application money shall be refunded to the applicants forthwith, failing which interest shall be due to be paid to the applicants at the rate of fifteen per cent per annum for the delayed period as prescribed under Companies Act, 2013, the SEBI (ICDR) Regulations and other applicable law.

Our Company and the Selling Shareholder shall ensure that all steps for the completion of the necessary formalities for listing and commencement of trading at the EMERGE Platform of NSE mentioned above are taken within 6 Working Days of the Issue Closing Date.

Our Company has obtained approval from NSE vide letter dated May 18, 2018 to use the name of NSE in this Offer document for listing of equity shares on EMERGE Platform of NSE.



Price Information of past issues handled by the Lead Manager

Sr. No.	Issue Name	Issue size (₹ Cr.)	Issue Price (₹)	Listing date	Opening price on listing date	+/- % change in Price on closing price, [+/- % change in closing benchmark]- 30 th calendar days from listing		+/- % change in Price on closing price, [+/- % change in closing benchmark]- 90 th calendar days from listing		+/- % change in Price on closing price, [+/- % change in closing benchmark]- 180 th calendar days from listing	
1.	Ambani Organics Ltd.	9.30	66.00	18/07/2018	66.65	N.A.	N.A.	N.A.	N.A.	N.A.	N.A.
2.	Jakharia Fabric Ltd.	19.66	180.00	11/07/2018	181.35	N.A.	N.A.	N.A.	N.A.	N.A.	N.A.
3.	Garv Industries Ltd.	3.20	10.00	25/04/2018	10.00	-10.00%	1.23%	N.A.	N.A.	N.A.	N.A.
4.	Giriraj Civil Developers Ltd.	9.00	100.00	02/04/2018	101.00	1.00%	4.96%	33.75%	4.92%	N.A.	N.A.
5.	Yasho Industries Ltd.	28.99	100.00	02/04/2018	106.00	6.00%	5.78%	6.00%	6.52%	N.A.	N.A.
6.	Karda Constructions Ltd.	77.40	180.00	02/04/2018	136.00	4.03%	5.78%	-3.36%	6.52%	N.A.	N.A.
7.	Uravi T and Wedge Lamps Ltd.	15.00	100.00	28/03/2018	102.50	3.00%	5.72%	5.00%	6.48%	N.A.	N.A.
8.	Advitya Trade India Ltd.	4.31	15.00	26/03/2018	15.01	75.33%	4.34%	11.00%	6.71%	N.A.	N.A.
9.	Shreeshay Engineers Ltd.	5.40	15.00	21/03/2018	15.25	20.00%	3.86%	20.00%	6.49%	N.A.	N.A.
10.	CKP Leisure Ltd.	11.54	30.00	06/03/2018	27.00	6.67%	0.74%	-29.17%	3.70%	N.A.	N.A.

Summary Statement of Disclosure

Financial Year	Total no. of IPOs	Total Funds Raised (₹ in Cr.)	Nos. of IPOs trading at discount - 30 th calendar day from listing day			Nos. of IPOs trading at premium - 30 th calendar day from listing day			Nos. of IPOs trading at discount - 180 th calendar day from listing day			Nos. of IPOs trading at premium - 180 th calendar day from listing day		
			Over 50%	Between 25-50%	Less than 25%	Over 50%	Between 25-50%	Less than 25%	Over 50%	Between 25-50%	Less than 25%	Over 50%	Between 25-50%	Less than 25%
2018-19	6 ⁽¹⁾	147.28	-	-	1	-	-	3	-	-	-	-	-	-
2017-18	16	318.24	1	1	4	1	1	8	2	2	1	-	-	4
2016-17	10	147.26	-	1	-	1	-	8	-	1	-	2	3	4
2015-16	3	15.90	-	-	-	-	-	3	-	-	-	1	1	1



⁽¹⁾Details indicated in 2018-19 are for the IPOs completed as on date.

Notes:

- a) Since the listing date of Ambani Organics Limited and Jakharia Fabric Limited was July 18, 2018 and July 11, 2018 respectively, information related to closing price and benchmark index as on the 30th calendar day, 90th calendar day and 180th calendar day from the listing date is not available.
- b) Since the listing date of Garv Industries Limited was April 25, 2018, information related to closing price and benchmark index as on the 90th calendar day and 180th calendar day from the listing date is not available.
- c) Since the listing date of Giriraj Civil Developers, Yasho Industries Limited, Karda Constructions Limited, Uravi T and Wedge Lamps Limited, Advitya Trade India Limited, Shreeshay Engineers Limited and CKP Leisure Limited, was April 02, 2018, April 02, 2018, April 02, 2018, March 28, 2018, March 26, 2018, March 21, 2018 and March 06, 2018, respectively, information related to closing price and benchmark index as on the 180th calendar day from the listing date is not available.
- d) The respective Designated Stock Exchange for each Issue has been considered as the Benchmark index for each of the above Issues.
- e) In the event any day falls on a holiday, the price/index of the immediate preceding working day has been considered. If the stock was not traded on the said calendar days from the date of listing, the share price is taken of the immediately preceding trading day.
- f) Source: www.bseindia.com and www.nseindia.com and BSE Sensex and NSE Nifty as the Benchmark Index.



Track record of past issues handled by the Lead Manager

For details regarding the track record of the Lead Manager to the Issue as specified in Circular reference CIR/MIRSD/1/ 2012 dated January 10, 2012 issued by the SEBI, please see the website of Aryaman Financial Services Limited – www.afsl.co.in

Consents

Consents in writing of: (a) The Directors, the Chief Financial Officer, Company Secretary & Compliance Officer, Banker(s) to the Company, the Statutory Auditor/ Peer Review Auditor; and (b) the Lead Manager, Registrar to the Issue, the Share Escrow Agent, the Legal Advisors to the Issue, Banker to the Issue, Market Maker and Underwriters to act in their respective capacities, have been obtained and shall be filed along with a copy of the Prospectus with the RoC, as required under Section 26 of the Companies Act, 2013 and such consents shall not be withdrawn up to the time of delivery of the Prospectus for registration with the RoC.

Expert Opinion

Except as stated below, our Company has not obtained any expert opinions:

Our Company has received written consent from the Auditor namely, M/s R A Maru & Associates, Chartered Accountant (Peer Review Auditors / Statutory Auditors) to include their name as required under section 26(1)(a)(v) of the Companies Act, 2013 in this Prospectus and as “Expert” as defined under section 2(38) of the Companies Act, 2013 in respect of the reports on the Restated Financial Statements dated July 14, 2018 and the Statement of Tax Benefits dated July 14, 2018, issued by them, included in this Prospectus and such consent has not been withdrawn as on the date of this Prospectus. However, the term “expert” shall not be construed to mean an “expert” as defined under the U.S. Securities Act.

ISSUE RELATED EXPENSES

The expenses of this Issue include, among others, underwriting and management fees, Market Making Fees, selling commissions, SCSB’s commission/ fees, printing and distribution expenses, legal fees, statutory advertisement expenses, registrar and depository fees and listing fees is given below:

Sr. No.	Particulars	Amount (₹ in lakhs)	% of Total Expenses	% of Total Issue size
1.	Issue Management fees including fees and reimbursements of Market Making fees (1 st year), and payment to other intermediaries such as Legal Advisors, Registrars and other out of pocket expenses.	39.00	77.61%	4.13%
2.	Brokerage and Selling Commission, Underwriting Commission, RTAs and CDPs ⁽¹⁾⁽²⁾⁽³⁾⁽⁴⁾	1.25	2.49%	0.13%
3.	Advertisement, Printing & Stationery, Marketing Expenses, etc.	4.00	7.96%	0.42%
4.	Listing Fees, Market Regulatory & Other Expenses	6.00	11.94%	0.64%
Total		50.25	100.00%	5.32%

1. Except for the Listing Fees & the Market Making Fees, which will be borne by our Company, all other expenses relating to the Issue as mentioned above will be borne by the Company and Selling Shareholders in proportion to the Equity Shares contributed to the Issue. The Issue expenses are estimated expenses and subject to change.
2. The SCSBs and other intermediaries will be entitled to a commission of ₹ 10 per every valid Application Form submitted to them and uploaded on the electronic system of the Stock Exchange by them.
3. The SCSBs would be entitled to processing fees of ₹ 10 per Application Form, for processing the Application Forms procured by other intermediaries and submitted to the SCSBs.



4. Further the SCSBs and other intermediaries will be entitled to selling commission of 0.01 % of the Amount Allotted (product of the number of Equity Shares Allotted and the Issue Price) for the forms directly procured by them and uploaded on the electronic system of the Stock Exchange by them.

Fees, Brokerage and Selling Commission Payable to the Lead Manager

The total fees payable to the Lead Manager (including underwriting commission and selling commission) is as stated in the MOUs dated March 22, 2018 and addendum dated June 12, 2018, the Underwriting Agreement dated March 22, 2018 and addendum dated June 12, 2018 and the Market Making Agreement dated March 22, 2018 and addendum dated June 12, 2018 among our Company and the Lead Manager and other parties, a copy of which will be made available for inspection at our Registered Office.

Fees Payable to the Registrar to the Issue

The fees payable to the Registrar to the Issue, for processing of application, data entry, printing of refund order, preparation of refund data on magnetic tape, printing of bulk mailing register will be as per the MoU between the Company, and the Registrar to the Issue dated December 28, 2017.

The Registrar to the Issue will be reimbursed for all out-of-pocket expenses including cost of stationery, postage, stamp duty and communication expenses. Adequate funds will be provided to the Registrar to the Issue to enable it to send refund orders or Allotment advice by registered post/speed post.

CAPITAL ISSUE DURING THE LAST FIVE YEARS

Previous Public and Rights Issues

We have not made any rights and public issues (including any right issue to the public), in the past, and we are an “Unlisted Company” in terms of the SEBI (ICDR) Regulations and this Issue is an “Initial Public Offering” in terms of the SEBI (ICDR) Regulations.

Previous Issues of Equity Shares otherwise than for Cash

Except as stated in the chapter titled “*Capital Structure*” beginning on page no. 60 of this Prospectus, we have not issued any Equity Shares for consideration other than for cash.

Commission and Brokerage Paid on Previous Issues of our Equity Shares

Since this is an Initial Public Offer of the Company, no sum has been paid or has been payable as commission or brokerage for subscribing to or procuring or agreeing to procure subscription for any of the Equity Shares since inception of the Company.

Capital Issues in the last three (3) years by Listed Group Companies / Subsidiaries / Associates

None of our Group Companies / Associates is listed on any Stock Exchange and hence there is no Capital Issue Further, we do not have any subsidiary as on date of this Prospectus.

PROMISE V. PERFORMANCE (ISSUER AND LISTED GROUP COMPANIES / SUBSIDIARIES / ASSOCIATES)

Our Company has not made any rights and public issues in the past. None of our Group Companies / Associates is listed on any Stock Exchange and not made any rights and public issues in the past. Further, we do not have any subsidiary as on date of this Prospectus



OUTSTANDING DEBENTURES, BONDS, REDEEMABLE PREFERENCE SHARES AND OTHER INSTRUMENTS ISSUED BY THE COMPANY

The Company has no outstanding debentures or bonds and redeemable preference shares and other instruments as on the date of Prospectus.

Stock Market Data for our Equity Shares

This being an initial public offer of the Company, the Equity Shares of the Company are not listed on any stock exchange.

DISPOSAL OF INVESTOR GRIEVANCES

Mechanism for Redressal of Investor Grievances

The Company has appointed Bigshare Services Private Limited as the Registrar to the Issue, to handle the investor grievances in co-ordination with the Compliance Officer of the Company. All grievances relating to the present Issue may be addressed to the Registrar with a copy to the Compliance Officer, giving full details such as name, address of the applicant, number of Equity Shares applied for, amount paid on application and name of bank and branch. The Company would monitor the work of the Registrar to ensure that the investor grievances are settled expeditiously and satisfactorily.

The Registrar to the Issue will handle investor's grievances pertaining to the Issue. A fortnightly status report of the complaints received and redressed by them would be forwarded to the Company. The Company would also be co-ordinating with the Registrar to the Issue in attending to the grievances to the investor.

All grievances relating to the ASBA process may be addressed to the SCSBs, giving full details such as name, address of the applicant, number of Equity Shares applied for, amount paid on application and the Designated Branch of the SCSB where the Application Form was submitted by the ASBA Applicant. We estimate that the average time required by us or the Registrar to the Issue or the SCSBs for the redressal of routine investor grievances will be seven business days from the date of receipt of the complaint. In case of non-routine complaints and complaints where external agencies are involved, we will seek to redress these complaints as expeditiously as possible.

Our Board by a resolution on December 26, 2017 constituted a Stakeholders Relationship Committee. The composition of the Stakeholders Relationship Committee is as follows:

Name of the Member	Nature of Directorship	Designation in Committee
Mrs. Smita S Patel	Chairman	Non-Executive Non-Independent Director
Mr. Sanjay J Patel	Member	Managing Director
Mrs. Taruna P Patel	Member	Non-Executive Non- Independent Director

For further details, please see the chapter titled "*Our Management*" beginning on page no. 128 of this Prospectus.

The Company has also appointed Ms. Neelam Pathak as the Company Secretary and Compliance Officer for this Issue and she may be contacted at the Registered Office of our Company. The contact details are as follows:

Name: Ms. Neelam Pathak

Address: Plot No- PAP D-146/147, TTC MIDC, Turbhe, Navi Mumbai - 400705

Tel No: +91 22 2762 0641 /42 /43

Fax No: +91 22 2762 0623

Email: cs@sakethexim.com



Investors can contact the Compliance Officer or the Registrar to the Issue or the Lead Manager in case of any pre-Issue or post-Issue related problems, such as non-receipt of letters of Allotment, credit of Allotted Equity Shares in the respective beneficiary accounts and refund orders.

Status of Investor Complaints

We confirm that we have not received any investor complaint during the three years preceding the date of this Prospectus and also there are no pending investor complaints as on the date of this Prospectus.

Disposal of Investor Grievances by Listed Companies under the same Management as the Company

No company under the same management as the Company within the meaning of Section 370(1B) of the Companies Act, 1956 has made any public issue (including any rights issues to the public) during the last three years and hence there are no pending investor grievances.

Change in Auditors

Except for as mentioned below, there have not been any other changes in our auditors in the last three years

1. Appointment of M/s. Kiran Mehta & Co. in place of M/s. Jayant & Company vide Resolution passed in the EGM dated October 28, 2017;
2. Appointment of M/s. R A Maru & Associates in place of M/s. Kiran Mehta & Co. vide Resolution passed in the EGM dated June 14, 2018.

Capitalisation of Reserves or Profits

Except as stated in the chapter titled “*Capital Structure*” beginning on page no. 60 of this Prospectus, our Company has not capitalised our reserves or profits during the last five years.

Revaluation of Assets

We have not revalued our assets in the last 5 years.



SECTION IX – ISSUE RELATED INFORMATION

TERMS OF THE ISSUE

The Equity Shares being offered and transferred pursuant to this Issue are subject to the provisions of the Companies Act, SEBI (ICDR) Regulations, 2009, our Memorandum and Articles of Association, the terms of this Prospectus, the Application Form, the Revision Form, the Confirmation of Allocation Note and other terms and conditions as may be incorporated in the allotment advices and other documents/certificates that may be executed in respect of this Issue. The Equity Shares shall also be subject to laws as applicable, guidelines, notifications and regulations relating to the issue of capital and listing and trading of securities issued from time to time by SEBI, the Government of India, the Stock Exchanges, the RBI, RoC and/or other authorities, as in force on the date of the Issue and to the extent applicable, or such other conditions as may be prescribed by SEBI, RBI, the Government of India, the Stock Exchanges, the RoC and/or any other authorities while granting its approval for the Issue.

Authority for the Issue

This Issue of Equity Shares has been authorized by the Board of Directors of our Company at their meeting held on March 20, 2018 and was approved by the Shareholders of the Company by passing a Special Resolution at the Extra-Ordinary General Meeting held with a shorter notice on March 22, 2018 in accordance with the provisions of Section 62 (1)(c) of the Companies Act, 2013.

The Offer for Sale has been authorised by Mr. Piyush J Patel (“Selling Shareholder”) by his consent letter dated March 19, 2018 to offer 2,45,000 Equity Shares.

The Selling Shareholder have severally confirmed that the Equity Shares proposed to be offered and sold in the Issue are eligible in term of SEBI (ICDR) Regulations and that they have not been prohibited from dealings in securities market and the Equity Shares offered and sold are free from any lien, encumbrance or third party rights. The Selling Shareholders have also severally confirmed that they are the legal and beneficial owners of the Equity Shares being offered by them under the Offer for Sale.

Offer for Sale

The Issue comprises of a Fresh Issue and an Offer for Sale by the Selling Shareholder. The fees and expenses relating to the Issue shall be shared in the proportion mutually agreed between the Company and the Selling Shareholder in accordance with applicable law. However, for ease of operations, expenses of the Selling Shareholder may, at the outset, be borne by our Company on behalf of the Selling Shareholder, and the Selling Shareholder agree that they will reimburse our Company all such expenses.

Ranking of Equity Shares

The Equity Shares being issued and transferred pursuant to the Issue shall be subject to the provisions of the Companies Act, our Memorandum and Articles of Association and shall rank pari-passu in all respects including dividend with the existing Equity Shares including in respect of the rights to receive dividends and other corporate benefits, if any, declared by us after the date of Allotment.

For further details, please see the section titled “*Main Provisions of the Articles of Association*”, beginning on page no. 278 of this Prospectus.

Mode of Payment of Dividend

The declaration and payment of dividend will be as per the provisions of Companies Act, 2013, the Memorandum and Articles of Association, and recommended by the Board of Directors and the Shareholders at their discretion and will depend on a number of factors, including but not limited to earnings, capital requirements and overall



financial condition of our Company. In respect of the Offer for Sale, all dividends, if any, declared by our Company after the date of Allotment, will be payable to the Applicants who have been issued and allotted Equity Shares in such Issue for the entire year. For further details, please refer the chapter titled "Dividend Policy" and "Main Provisions of Article of Association" beginning on page nos. 150 and 278 of this Prospectus.

Face Value and Issue Price

The Equity Shares having a face value of ₹ 10 each are being offered in terms of this Prospectus at the price of ₹ 69/- per Equity Share. The Issue Price is decided by our Company and the Selling Shareholder, in consultation with the Lead Manager and is justified under the section titled "Basis of Issue Price" beginning on page no. 78 of this Prospectus. At any given point of time there shall be only one denomination of the Equity Shares of our Company, subject to applicable laws.

Compliance with the disclosure and accounting norms

Our Company shall comply with all requirements of the SEBI (ICDR) Regulations. Our Company shall also comply with all disclosure and accounting norms as specified by SEBI from time to time.

Rights of the Equity Shareholders

Subject to applicable laws, rules, regulations and guidelines and the Articles of Association, the equity shareholders shall have the following rights:

- ✓ Right to receive dividend, if declared;
- ✓ Right to attend general meetings and exercise voting rights, unless prohibited by law;
- ✓ Right to vote on a poll either in person or by proxy;
- ✓ Right to receive offer for rights shares and be allotted bonus shares, if announced;
- ✓ Right to receive surplus on liquidation;
- ✓ Right of free transferability; and
- ✓ Such other rights, as may be available to a shareholder of a listed Public Limited Company under the Companies Act, the Listing Regulations and the Memorandum and Articles of Association of our Company.

For a detailed description of the main provision of the Articles of Association of our Company relating to voting rights, dividend, forfeiture and lien and / or consolidation / splitting, etc., please refer the section titled "Main Provisions of Articles of Association " beginning on page no. 278 of this Prospectus.

Minimum Application Value; Market Lot and Trading Lot

In terms of Section 29 of Companies Act, 2013, the Equity Shares shall be allotted only in dematerialised form. As per the SEBI Regulations, the trading of the Equity Shares shall only be in dematerialised form. In this context, two agreements have been signed among our Company, the respective Depositories and the Registrar and Share Transfer Agent to the Issue:

- 1) Tripartite agreement dated December 15, 2017 between our Company, NSDL and the Registrar and Share Transfer Agent to the Issue.
- 2) Tripartite agreement dated November 29, 2017 between our Company, CDSL and the Registrar and Share Transfer Agent to the Issue.

Trading of the Equity Shares will happen in the minimum contract size of 2,000 Equity Shares in terms of the SEBI circular No. CIR/MRD/DSA/06/2012 dated February 21, 2012 and the same may be modified by EMERGE platform of NSE from time to time by giving prior notice to investors at large. Allocation and allotment of Equity



Shares through this Issue will be done in multiples of 2,000 Equity Share subject to a minimum allotment of 2,000 Equity Shares to the successful Applicants.

Minimum Number of Allottees

In accordance with Regulation 106R of SEBI (ICDR) Regulations, the minimum number of allottees in this Issue shall be 50 shareholders. In case the minimum number of prospective allottees is less than 50, no allotment will be made pursuant to this Issue and the monies collected shall be refunded within 6 Working days of closure of Issue.

Joint Holders

Where two or more persons are registered as the holders of any Equity Shares, they will be deemed to hold such Equity Shares as joint-holders with benefits of survivorship.

Nomination Facility to Investor

In accordance with Section 72 (1) & 72 (2) of the Companies Act, 2013, the sole or first applicant, along with other joint applicant, may nominate any one person in whom, in the event of the death of sole applicant or in case of joint applicant, death of all the applicants, as the case may be, the Equity Shares allotted, if any, shall vest. A person, being a nominee, entitled to the Equity Shares by reason of the death of the original holder(s), shall in accordance with Section 72 (3) of the Companies Act, 2013, be entitled to the same advantages to which he or she would be entitled if he or she were the registered holder of the equity Share(s). Where the nominee is a minor, the holder(s) may make a nomination to appoint, in accordance to Section 72 (4) of the Companies Act, 2013, any person to become entitled to Equity Share(s) in the event of his or her death during the minority. A nomination shall stand rescinded upon a sale of equity share(s) by the person nominating. A buyer will be entitled to make a fresh nomination in the manner prescribed. Fresh nomination can be made only on the prescribed form available on request at the Registered Office of our Company or to the Registrar and Transfer Agents of our Company.

In accordance with Articles of Association of the Company, any Person who becomes a nominee by virtue of Section 72 of the Companies Act, 2013, shall upon the production of such evidence as may be required by the Board, elect either:

- ✓ to register himself or herself as the holder of the Equity Shares; or
- ✓ to make such transfer of the Equity Shares, as the deceased holder could have made

Further, the Board may at any time give notice requiring any nominee to choose either to be registered himself or herself or to transfer the Equity Shares, and if the notice is not complied with within a period of ninety days, the Board may thereafter withhold payment of all dividends, bonuses or other moneys payable in respect of the Equity Shares, until the requirements of the notice have been complied with. In case the allotment of Equity Shares is in dematerialized form, there is no need to make a separate nomination with us. Nominations registered with the respective depository participant of the applicant would prevail. If the investors require changing the nomination, they are requested to inform their respective depository participant.

Withdrawal of the Issue

Our Company and the Selling Shareholder, in consultation with the Lead Manager, reserves the right not to proceed with the Issue at any time after the Issue Opening Date but before the Allotment. In such an event, our Company would issue a public notice in the newspapers in which the pre-Issue advertisements were published, within two days of the Issue Closing Date or such other time as may be prescribed by SEBI, providing reasons for not proceeding with the Issue. The Lead Manager, through the Registrar to the Issue, shall notify the SCSBs to unblock the bank accounts of the ASBA Applicants within one day of receipt of such notification. Our Company shall also promptly inform the Stock Exchange on which the Equity Shares were proposed to be listed.



If our Company and/or the Selling Shareholder withdraws the Issue after the Issue Closing Date and thereafter determines that it will proceed with an Issue of the Equity Shares, our Company shall file a fresh Draft Offer Document. Notwithstanding the foregoing, the Issue is also subject to obtaining the final listing and trading approvals of the Stock Exchange, which our Company shall apply for after Allotment.

ISSUE PROGRAMME

An indicative timetable in respect of the Issue is set out below:

Event	Indicative Date
Issue Opening Date	August 01, 2018
Issue Closing Date	August 03, 2018
Finalisation of Basis of Allotment with the Designated Stock Exchange	August 08, 2018
Initiation of Refunds/ unblocking of funds	August 09, 2018
Credit of Equity Shares to demat accounts of Allottees	August 10, 2018
Commencement of trading of the Equity Shares on the Stock Exchange	August 13, 2018

The above timetable is indicative and does not constitute any obligation on our Company, the Selling Shareholder or the Lead Manager. Whilst our Company shall ensure that all steps for the completion of the necessary formalities for the listing and the commencement of trading of the Equity Shares on the Stock Exchange are taken within 6 Working Days of the Issue Closing Date, the timetable may change due to various factors, such as extension of the Issue Period by our Company, or any delays in receiving the final listing and trading approval from the Stock Exchange. The Commencement of trading of the Equity Shares will be entirely at the discretion of the Stock Exchange and in accordance with the applicable laws.

Applications and any revision to the same shall be accepted **only between 10.00 a. m. and 5.00 p. m.** (IST) during the Issue Period. On the Issue Closing Date, the Applications and any revision to the same shall be accepted only between **10.00 a. m. and 3.00 p. m.** (IST) or such extended time as permitted by the Stock Exchanges, in case of Applications by Retail Individual Applicants after taking into account the total number of applications received up to the closure of timings and reported by the Lead Manager to the Stock Exchanges. It is clarified that Applications not uploaded on the electronic system would be rejected. Applications will be accepted only on Working Days, i.e., Monday to Friday (excluding any public holiday).

Due to limitation of time available for uploading the Applications on the Issue Closing Date, the Applicants are advised to submit their Applications one day prior to the Issue Closing Date and, in any case, no later than 3.00 p.m. (IST) on the Issue Closing Date. All times mentioned in this Prospectus are Indian Standard Times. Applicants are cautioned that in the event a large number of Applications are received on the Issue Closing Date, as is typically experienced in public offerings, some Applications may not get uploaded due to lack of sufficient time. Such Applications that cannot be uploaded will not be considered for allocation under the Issue. Applications will be accepted only on Business Days. Neither our Company nor the Lead Manager is liable for any failure in uploading the Applications due to faults in any software/hardware system or otherwise.

In accordance with the SEBI Regulations, QIBs and Non-Institutional Applicants are not allowed to withdraw or lower the size of their Applications (in terms of the quantity of the Equity Shares or the Applications Amount) at any stage. Retail Individual Applicants can revise or withdraw their Applications prior to the Issue Closing Date. Except Allocation to Retail Individual Investors, Allocation in the Issue will be on a proportionate basis.

In case of discrepancy in the data entered in the electronic book vis-a-vis the data contained in the physical Application Form, for a particular Applicant, the details as per the file received from the Stock Exchange may be taken as the final data for the purpose of Allotment. In case of discrepancy in the data entered in the electronic book vis-a-vis the data contained in the physical or electronic Application Form, for a particular ASBA Applicant, the



Registrar to the Issue shall ask the relevant SCSBs / RTAs / DPs / Stock Brokers, as the case may be, for rectified data.

Minimum Subscription

The requirement for 90% minimum subscription in terms of Regulation 14 of the ICDR Regulations is not applicable to the Issue. In terms of Regulation 106P(1) of the ICDR Regulations, the Issue is not restricted to any minimum subscription level and is 100% underwritten. Further, pursuant to Regulation 106R of the ICDR Regulations, our Company shall ensure that the number of prospective allottees to whom Equity Shares will be allotted shall not be less than 50.

If we do not receive the subscription of 100% of the Issue through this offer document including devolvement of Underwriters within sixty days from the date of closure of the Issue, we shall forthwith refund the entire subscription amount received. If there is a delay beyond eight days after we become liable to pay the amount, we shall pay interest prescribed under the applicable provisions of the Companies Act, 2013.

Arrangements for Disposal of Odd Lots

The trading of the Equity Shares will happen in the minimum contract size of 2,000 shares. However, the Market Maker shall buy the entire shareholding of a shareholder in one lot, where value of such shareholding is less than the minimum contract size allowed for trading on the EMERGE platform of NSE.

Restrictions, if any, on transfer and transmission of shares or debentures and on their consolidation or splitting

For a detailed description in respect of restrictions, if any, on transfer and transmission of shares and on their consolidation / splitting, please refer the section titled "*Main Provisions of the Articles of Association*" beginning on page no. 278 of this Prospectus.

New Financial Instruments

Our Company is not issuing any new financial instruments through this Issue.

Option to receive Equity Shares in Dematerialized Form

As per Section 29(1) of the Companies Act, 2013, allotment of Equity Shares will be made only in dematerialized form.

As per SEBI's circular RMB (compendium) series circular no. 2 (1999-2000) dated February 16, 2000, it has been decided by the SEBI that trading in securities of companies making an initial public offer shall be in Dematerialised form only. The Equity Shares on Allotment will be traded only on the dematerialized segment of the EMERGE Platform of NSE.

Migration to Main Board

In accordance with the NSE Circular dated March 10, 2014, our Company will have to be mandatorily listed and traded on the EMERGE Platform of the NSE for a minimum period of two years from the date of listing and only after that it can migrate to the Main Board of the NSE as per the guidelines specified by SEBI and as per the procedures laid down under Chapter XB of the SEBI (ICDR) Regulations.

As per the provisions of the Chapter XB of the SEBI (ICDR) Regulation, 2009, our Company may migrate to the main board of NSE from the EMERGE platform on a later date subject to the following:



- If the Paid up Capital of the Company is likely to increase above ₹ 25 Crores by virtue of any further issue of capital by way of rights, preferential issue, bonus issue etc. (which has been approved by a special resolution through postal ballot wherein the votes cast by the shareholders other than the promoters in favour of the proposal amount to at least two times the number of votes cast by shareholders other than promoter shareholders against the proposal and for which the Company has obtained in-principal approval from the main board), we shall have to apply to NSE for listing our shares on its main board subject to the fulfilment of the eligibility criteria for listing of specified securities laid down by the Main Board
- If the Paid up Capital of the company is more than ₹ 10 crores but below ₹ 25 crores, we may still apply for migration to the main board if the same has been approved by a special resolution through postal ballot wherein the votes cast by the shareholders other than the promoters in favour of the proposal amount to at least two times the number of votes cast by shareholders other than promoter shareholders against the proposal.

Market Making

The shares offered through this Issue are proposed to be listed on the EMERGE Platform of NSE (SME Exchange), wherein the Lead Manager to this Issue shall ensure compulsory Market Making through the registered Market Maker of the SME Exchange for a minimum period of three years from the date of listing on the EMERGE Platform of NSE.

For further details of the agreement entered into between our Company, the Lead Manager and the Market Maker, please refer the chapter titled "*General Information - Details of the Market Making Arrangement for this Issue*" beginning on page no. 52 of this Prospectus.

Jurisdiction

Exclusive jurisdiction for the purpose of this Issue is with the competent courts / authorities in Mumbai. The Equity Shares have not been and will not be registered under the Securities Act or any state securities laws in the United States, and may not be offered or sold within the United States, except pursuant to an exemption from or in a transaction not subject to, registration requirements of the Securities Act. Accordingly, the Equity Shares are only being offered or sold outside the United States in compliance with Regulation S under the Securities Act and the applicable laws of the jurisdictions where those offers and sales occur. The Equity Shares have not been and will not be registered, listed or otherwise qualified in any other jurisdiction outside India and may not be offered or sold, and applications may not be made by persons in any such jurisdiction, except in compliance with the applicable laws of such jurisdiction.



ISSUE STRUCTURE

This Issue is being made in terms of Regulation 106 (M) (1) of Chapter XB of the SEBI (ICDR) Regulations, 2009, as amended from time to time, whereby, a Company whose post issue/offer face value capital does not exceed ten crore rupees, shall issue/offer shares to the public and propose to list the same on the Small and Medium Enterprise Exchange ("SME Exchange", in this case being the EMERGE Platform of NSE). For further details regarding the salient features and terms of such this Issue, please refer the chapters titled "*Terms of the Issue*" and "*Issue Procedure*" beginning on page nos. 216 and 225 respectively, of this Prospectus.

Issue Structure:

Initial Public Offer of 13,68,000 Equity Shares of ₹ 10 each (the "Equity Shares") for cash at a price of ₹ 69/- per Equity Share (including a Share premium of ₹ 59/- per Equity Share) aggregating to ₹ 943.92 lakhs ("the Issue") by Saketh Exim Limited ("SEL" or the "Company").

The Issue comprises a Net Issue to Public of 12,96,000 Equity Shares of ₹ 10 each ("the Net Issue"), and a reservation of 72,000 Equity Shares of ₹ 10 each for subscription by the designated Market Maker ("the Market Maker Reservation Portion"). The Issue and the Net Issue will constitute 27.23% and 25.80%, respectively of the post Issue paid up equity share capital of the company. The Issue is being made through the Fixed Price Process:

Particulars of the Issue	Net Issue to Public	Market Maker Reservation Portion
Number of Equity Shares available for allocation	12,96,000 Equity Shares	72,000 Equity Shares
Percentage of Issue Size available for allocation	94.74% of the Issue Size	5.26% of the Issue Size
Basis of Allotment	Proportionate subject to minimum allotment of 2,000 Equity Shares and further allotment in multiples of 2,000 Equity Shares each. For further details please refer to the " <i>Basis of Allotment</i> " on page no. 266 of this Prospectus.	Firm Allotment
Minimum Application Size	<i>For QIB and NII:</i> Such number of Equity Shares in multiples of 2,000 Equity Shares such that the Application Value exceeds ₹ 2,00,000 <i>For Retail Individuals:</i> 2,000 Equity Shares	72,000 Equity Shares
Maximum Application Size	<i>For QIB and NII:</i> Such number of Equity Shares in multiples of 2,000 Equity Shares such that the Application Size does not exceed 12,96,000 Equity Shares. <i>For Retail Individuals:</i> Such number of Equity Shares in multiples of 2,000 Equity Shares such that the Application Value does not exceed ₹ 2,00,000	72,000 Equity Shares
Mode of Allotment	Dematerialized Form	Dematerialized Form



Particulars of the Issue	Net Issue to Public	Market Maker Reservation Portion
Trading Lot	2,000 Equity Shares	2,000 Equity Shares, However the Market Maker may accept odd lots if any in the market as required under the SEBI (ICDR) Regulations, 2009.
Terms of Payment	The entire Application Amount will be payable at the time of submission of the Application Form.	
Application Lot Size	2,000 Equity Shares and in multiples of 2,000 Equity Shares thereafter	

- 1) 50% of the Equity Share offered are reserved for allocation to Applicants below or equal to ₹ 2.00 lakhs and the balance for higher amount Applications.
- 2) In case of joint Applications, the Application Form should contain only the name of the First Applicant whose name should also appear as the first holder of the beneficiary account held in joint names. The signature of only such First Applicant would be required in the Application Form and such First Applicant would be deemed to have signed on behalf of the joint holders.
- 3) Applicants will be required to confirm and will be deemed to have represented to our Company, the Selling Shareholder, the Lead Manager, their respective directors, officers, agents, affiliates and representatives that they are eligible under applicable laws, rules, regulations, guidelines and approvals to acquire the Equity Shares in this Issue.
- 4) SCSBs applying in the Issue must apply through an ASBA Account maintained with any other SCSB.

Lot Size

SEBI vide circular CIR/MRD/DSA/06/2012 dated February 21, 2012 (the “Circular”) standardized the lot size for Initial Public Offer proposing to list on SME exchange/platform and for the secondary market trading on such exchange/platform, as under:

Issue Price (in ₹)	Lot Size (No. of shares)
Upto 14	10000
More than 14 upto 18	8000
More than 18 upto 25	6000
More than 25 upto 35	4000
More than 35 upto 50	3000
More than 50 upto 70	2000
More than 70 upto 90	1600
More than 90 upto 120	1200
More than 120 upto 150	1000
More than 150 upto 180	800
More than 180 upto 250	600
More than 250 upto 350	400
More than 350 upto 500	300
More than 500 upto 600	240
More than 600 upto 750	200
More than 750 upto 1000	160
Above 1000	100



Further to the Circular, at the Initial Public Offer stage the Registrar to Issue in consultation with Lead Manager, our Company and NSE shall ensure to finalize the basis of allotment in minimum lots and in multiples of minimum lot size, as per the above given table. The secondary market trading lot size shall be the same, as shall be the IPO Lot Size at the application/allotment stage, facilitating secondary market trading.



ISSUE PROCEDURE

All Applicants should review the General Information Document for Investing in public issues prepared and issued in accordance with the circular (CIR/CFD/DIL/12/2013) dated October 23, 2013 notified by SEBI (“General Information Document”), included below under “**Part B – General Information Document**”, which highlights the key rules, processes and procedures applicable to public issues in general in accordance with the provisions of the Companies Act, the Securities Contracts (Regulation) Act, 1956, the Securities Contracts (Regulation) Rules, 1957 and the SEBI ICDR Regulations. The General Information Document has been updated to include reference to the Securities and Exchange Board of India (Foreign Portfolio Investors) Regulations, 2014 and certain notified provisions of the Companies Act 2013, to the extent applicable to a public issue. The General Information Document would be made available with the Lead Manager and would also be made available on the websites of the Stock Exchanges and the Lead Manager before opening of Issue. Please refer to the relevant provisions of the General Information Document which are applicable to the Issue.

Our Company and the Lead Manager do not accept any responsibility for the completeness and accuracy of the information stated in this section and shall not be liable for any amendment, modification or change in the applicable law which may occur after the date of this Prospectus. Applicants are advised to make their independent investigations and ensure that their Applications are submitted in accordance with applicable laws and do not exceed the investment limits or maximum number of the Equity Shares that can be held by them under applicable law or as specified in this Prospectus.

Please note that all the Applicants can participate in the Issue only through the ASBA process. All Applicants shall ensure that the ASBA Account has sufficient credit balance such that the full Application Amount can be blocked by the SCSB at the time of submitting the Application. Applicants applying through the ASBA process should carefully read the provisions applicable to such applications before making their application through the ASBA process. Please note that all Applicants are required to make payment of the full Application Amount along with the Application Form. In case of ASBA Applicants, an amount equivalent to the full Application Amount will be blocked by the SCSBs.

ASBA Applicants are required to submit ASBA Applications to the Selected Branches / Offices of the RTAs, DPs, Designated Bank Branches of SCSBs. The lists of banks that have been notified by SEBI to act as SCSB (Self Certified Syndicate Banks) for the ASBA Process are provided on <http://www.sebi.gov.in>. For details on designated branches of SCSB collecting the Application Form, please refer the above mentioned SEBI link. The list of Stock Brokers, Depository Participants (“DP”), Registrar to an Issue and Share Transfer Agent (“RTA”) that have been notified by NSE to act as intermediaries for submitting Application Forms are provided on <http://www.bseindia.com>. For details on their designated branches for submitting Application Forms, please see the above mentioned NSE website.

Pursuant to the SEBI (Issue of Capital and Disclosure Requirements) (Fifth Amendment) Regulations, 2015, the ASBA process become mandatory for all investors w.e.f. January 1, 2016 and it allows the registrar, share transfer agents, depository participants and stock brokers to accept application forms.

PART A

FIXED PRICE ISSUE PROCEDURE

The Issue is being made in compliance with the provisions of Reg. 106(M)(1) of Chapter XB of the SEBI (ICDR) Regulations, 2009 and through the Fixed Price Process wherein 50% of the Net Issue to Public is being offered to the Retail Individual Applicants and the balance shall be offered to Non Retail Category i.e. QIBs and Non-Institutional Applicants. However, if the aggregate demand from the Retail Individual Applicants is less than 50%, then the balance Equity Shares in that portion will be added to the non retail portion offered to the remaining investors including QIBs and NIIs and vice-versa subject to valid Applications being received from them at or above the Issue Price.



Subject to the valid Applications being received at or above the Issue Price, allocation to all categories in the Net Issue, shall be made on a proportionate basis, except for the Retail Portion where Allotment to each Retail Individual Applicants shall not be less than the minimum lot, subject to availability of Equity Shares in Retail Portion, and the remaining available Equity Shares, if any, shall be allotted on a proportionate basis. Under subscription, if any, in any category, would be allowed to be met with spillover from any other category or a combination of categories at the discretion of our Company in consultation with the Lead Manager and the Stock Exchange.

Investors should note that according to section 29(1) of the Companies Act, 2013, allotment of Equity Shares to all successful Applicants will only be in the dematerialised form. The Application Forms which do not have the details of the Applicant's depository account including DP ID, PAN and Beneficiary Account Number shall be treated as incomplete and rejected. In case DP ID, Client ID and PAN mentioned in the Application Form and entered into the electronic application system of the stock exchanges, do not match with the DP ID, Client ID and PAN available in the depository database, the application is liable to be rejected. Applicants will not have the option of getting allotment of the Equity Shares in physical form. The Equity Shares on allotment shall be traded only in the dematerialised segment of the Stock Exchanges.

APPLICATION FORM

Copies of the Application Form and the abridged prospectus will be available at the offices of the Lead Manager, the Designated Intermediaries, and Registered Office of our Company. An electronic copy of the Application Form will also be available for download on the websites of the NSE (www.nseindia.com), the SCSBs, the Registered Brokers, the RTAs and the CDPs at least one day prior to the Issue Opening Date.

All Applicants shall mandatorily participate in the Issue only through the ASBA process. ASBA Applicants must provide bank account details and authorisation to block funds in the relevant space provided in the Application Form and the Application Forms that do not contain such details are liable to be rejected.

ASBA Applicants shall ensure that the Applications are made on Application Forms bearing the stamp of the Designated Intermediary, submitted at the Collection Centres only (except in case of electronic Application Forms) and the Application Forms not bearing such specified stamp are liable to be rejected.

The prescribed colour of the Application Form for various categories is as follows:

Category	Colour⁽¹⁾
Resident Indians and Eligible NRIs applying on a non-repatriation basis	White
Non-Residents and Eligible NRIs, FIIs, FVCIs, etc. applying on a repatriation basis	Blue

⁽¹⁾ excluding electronic Application Form

Designated Intermediaries shall submit Application Forms to SCSBs and shall not submit it to any non-SCSB bank.

Who Can Apply?

1. Indian nationals resident in India, who are not minors (except through their Legal Guardians), in single or joint names (not more than three);
2. Hindu Undivided Families or HUFs, in the individual name of the Karta. The Applicant should specify that the application is being made in the name of the HUF in the Application Form as follows: Name of Sole or First Applicant: XYZ Hindu Undivided Family applying through XYZ, where XYZ is the name of the Karta. Applications by HUFs would be considered at par with those from individuals;
3. Companies, Corporate Bodies and Societies registered under the applicable laws in India and authorised to invest in equity shares;



4. Mutual Funds registered with SEBI;
5. Eligible NRIs on a repatriation basis or on a non-repatriation basis subject to applicable laws. NRIs other than Eligible NRIs are not eligible to participate in this Issue;
6. Indian financial institutions, scheduled commercial banks (excluding foreign banks), regional rural banks, co-operative banks (subject to RBI regulations and the SEBI Regulations and other laws, as applicable);
7. FIIs and sub-accounts registered with SEBI, other than a sub-account which is a foreign corporate or foreign individual under the QIB portion;
8. Sub-accounts of FIIs registered with SEBI, which are foreign corporates or foreign individuals only under the Non-Institutional Applications portion;
9. VCFs registered with SEBI;
10. FVCIs registered with SEBI;
11. Eligible QFIs;
12. Foreign Nationals and other non-residents (subject to eligibility norms specified in SEBI FPI Regulations, 2014 and other applicable provisions)
13. Multilateral and bilateral development financial institutions;
14. State Industrial Development Corporations;
15. Trusts/societies registered under the Societies Registration Act, 1860, as amended, or under any other law relating to trusts/societies and who are authorised under their respective constitutions to hold and invest in equity shares;
16. Scientific and/or industrial research organizations authorized in India to invest in equity shares;
17. Insurance companies registered with Insurance Regulatory and Development Authority;
18. Provident Funds with a minimum corpus of ₹ 250 million and who are authorised under their constitution to hold and invest in equity shares;
19. Pension Funds with a minimum corpus of ₹ 250 million and who are authorised under their constitution to hold and invest in equity shares;
20. Limited liability partnerships;
21. National Investment Fund set up by resolution no. F.NO.2/3/2005-DDII dated November 23, 2005 of the GoI, published in the Gazette of India;
22. Nominated Investor and Market Maker
23. Insurance funds set up and managed by the army, navy or air force of the Union of India and by the Department of Posts, India



24. Any other person eligible to Apply in this Issue, under the laws, rules, regulations, guidelines and policies applicable to them and under Indian laws.

As per the existing policy of the Government of India, OCBs cannot participate in this Issue. Applicants are advised to ensure that any single Application from them does not exceed the investment limits or maximum number of Equity Shares that can be held by them under applicable law.

Applications not to be made by:

1. Minors (except through their Legal Guardians)
2. Partnership firms or their nominations
3. Overseas Corporate Bodies

Maximum and Minimum Application Size

a) For Retail Individual Applicants:

The Application must be for a minimum of 2,000 Equity Shares and in multiples of 2,000 Equity Shares thereafter, so as to ensure that the Application Amount payable by the Applicant does not exceed ₹ 2,00,000. In case of revision of the Application, the Retail Individual Applicants have to ensure that the Application Amount does not exceed ₹ 2,00,000.

b) For Other Applicants (Non-Institutional Applicants and QIBs):

The Application must be for a minimum of such number of Equity Shares such that the Application Amount exceeds ₹ 2,00,000 and in multiples of 2,000 Equity Shares thereafter. Application cannot be submitted for more than the Issue Size. However, the maximum application size by a QIB investor should not exceed the investment limits prescribed for them by applicable laws. **A QIB and a Non-Institutional Applicant cannot withdraw or lower the size of their Application at any stage and are required to pay the entire Application Amount upon submission of the Application.**

The identity of QIBs applying in the Net Issue shall not be made public during the Issue Period. In case of revision in Application, the Non-Institutional Applicants, who are individuals, have to ensure that the Application Amount is greater than ₹ 2,00,000 for being considered for allocation in the Non-Institutional Portion.

Information for the Applicants

- a) Our Company shall file the Prospectus with the RoC at least three working days before the Issue Opening Date.
- b) Our Company shall, after registering the Prospectus with the RoC, make a pre- issue advertisement, in the form prescribed under the ICDR Regulations, in English and Hindi national newspapers and one regional newspaper with wide circulation. In the pre- issue advertisement, our Company and the Lead Manager shall advertise the Issue Opening Date, the Issue Closing Date. This advertisement, subject to the provisions of the Companies Act, shall be in the format prescribed in Part A of Schedule XIII of the ICDR Regulations.
- c) Copies of the Application Form and the abridged prospectus will be available at the offices of the Lead Manager, the Designated Intermediaries, and Registered Office of our Company. An electronic copy of the Application Form will also be available for download on the websites of the NSE (www.nseindia.com), the SCSBs, the Registered Brokers, the RTAs and the CDPs at least one day prior to the Issue Opening Date.



- d) Applicants who are interested in subscribing to the Equity Shares should approach any of the Application Collecting Intermediaries or their authorized agent(s).
- e) Application should be submitted in the prescribed Application Form only. Application Forms submitted to the SCSBs should bear the stamp of the respective intermediary to whom the application form is submitted. Application Forms submitted directly to the SCSBs should bear the stamp of the SCSBs and / or the Designated Branch.
- f) The Application Form can be submitted either in physical or electronic mode, to the Application Collecting Intermediaries. Further Application Collecting Intermediary may provide the electronic mode of collecting either through an internet enabled collecting and banking facility or such other secured, electronically enabled mechanism for applying and blocking funds in the ASBA Account.

The Applicants should note that in case the PAN, the DP ID and Client ID mentioned in the Application Form and entered into the electronic system of the Stock Exchanges does not match with the PAN, DP ID and Client ID available in the database of Depositories, the Application Form is liable to be rejected.

Availability of the Prospectus and the Application Forms:

Copies of the Application Form and the abridged prospectus will be available at the offices of the Lead Manager, the Designated Intermediaries, and Registered Office of our Company. An electronic copy of the Application Form will also be available for download on the websites of the NSE (www.nseindia.com), the SCSBs, the Registered Brokers, the RTAs and the CDPs at least one day prior to the Issue Opening Date.

Participation by associates and affiliates of the Lead Manager

The Lead Manager shall not be allowed to subscribe to this Issue in any manner except towards fulfilling their underwriting obligations. However, the associates and affiliates of the Lead Manager may subscribe to Equity Shares in the Issue in non Retail Portion, where the allocation is on a proportionate basis.

Applications by Mutual Funds

With respect to Applications by Mutual Funds, a certified copy of their SEBI registration certificate must be lodged along with the Application Form. Failing this, our Company reserves the right to reject the Application without assigning any reason thereof.

Applications made by asset management companies or custodians of Mutual Funds shall specifically state names of the concerned schemes for which such Applications are made.

In case of a Mutual Fund, a separate Application can be made in respect of each scheme of the Mutual Fund registered with SEBI and such Applications in respect of more than one scheme of the Mutual Fund will not be treated as multiple Applications provided that the Applications clearly indicate the scheme concerned for which the Application has been made.

No Mutual Fund scheme shall invest more than 10% of its net asset value in equity shares or equity related instruments of any single company provided that the limit of 10% shall not be applicable for investments in case of index funds or sector or industry specific schemes. No Mutual Fund under all its schemes should own more than 10% of any company's paid-up share capital carrying voting rights.

Applications by Eligible NRIs

NRIs may obtain copies of Application Form from the offices of the Lead Manager and the Designated Intermediaries. Eligible NRI Applicants applying on a repatriation basis by using the Non-Resident Forms should authorize their SCSB to block their Non-Resident External ("NRE") accounts, or Foreign Currency Non-Resident



("FCNR") ASBA Accounts, and eligible NRI Applicants applying on a non-repatriation basis by using Resident Forms should authorize their SCSB to block their Non-Resident Ordinary ("NRO") accounts for the full Application Amount, at the time of the submission of the Application Form.

Eligible NRIs applying on non-repatriation basis are advised to use the Application Form for residents (white in colour).

Eligible NRIs applying on a repatriation basis are advised to use the Application Form meant for Non-Residents (blue in colour).

Applications by FPI and FIIs

In terms of the SEBI FPI Regulations, any qualified foreign investor or FII who holds a valid certificate of registration from SEBI shall be deemed to be an FPI until the expiry of the block of three years for which fees have been paid as per the SEBI FII Regulations. An FII or a sub-account may participate in this Issue, in accordance with Schedule 2 of the FEMA Regulations, until the expiry of its registration with SEBI as an FII or a sub-account. An FII shall not be eligible to invest as an FII after registering as an FPI under the SEBI FPI Regulations. Further, a qualified foreign investor who had not obtained a certificate of registration as an FPI could only continue to buy, sell or otherwise deal in securities until January 6, 2015. Hence, such qualified foreign investors who have not registered as FPIs under the SEBI FPI Regulations shall not be eligible to participate in this Issue.

In case of Applications made by FPIs, a certified copy of the certificate of registration issued by the designated depository participant under the FPI Regulations is required to be attached to the Application Form, failing which our Company reserves the right to reject any application without assigning any reason. An FII or subaccount may, subject to payment of conversion fees under the SEBI FPI Regulations, participate in the Issue, until the expiry of its registration as a FII or sub-account, or until it obtains a certificate of registration as FPI, whichever is earlier. Further, in case of Applications made by SEBI-registered FIIs or sub-accounts, which are not registered as FPIs, a certified copy of the certificate of registration as an FII issued by SEBI is required to be attached to the Application Form, failing which our Company reserves the right to reject any Application without assigning any reason.

In terms of the SEBI FPI Regulations, the issue of Equity Shares to a single FPI or an investor group (which means the same set of ultimate beneficial owner(s) investing through multiple entities) must be below 10.00% of our post-Issue Equity Share capital. Further, in terms of the FEMA Regulations, the total holding by each FPI shall be below 10.00% of the total paid-up Equity Share capital of our Company and the total holdings of all FPIs put together shall not exceed 24.00% of the paid-up Equity Share capital of our Company. The aggregate limit of 24.00% may be increased up to the sectorial cap by way of a resolution passed by the Board of Directors followed by a special resolution passed by the Shareholders of our Company and subject to prior intimation to RBI. In terms of the FEMA Regulations, for calculating the aggregate holding of FPIs in a company, holding of all registered FPIs as well as holding of FIIs (being deemed FPIs) shall be included. The existing individual and aggregate investment limits an FII or sub account in our Company is 10.00% and 24.00% of the total paid-up Equity Share capital of our Company, respectively.

FPIs are permitted to participate in the Issue subject to compliance with conditions and restrictions which may be specified by the Government from time to time.

Subject to compliance with all applicable Indian laws, rules, regulations, guidelines and approvals in terms of Regulation 22 of the SEBI FPI Regulations, an FPI, other than Category III foreign portfolio and unregulated broad based funds, which are classified as Category II foreign portfolio investor by virtue of their investment manager being appropriately regulated, may issue or otherwise deal in offshore derivative instruments (as defined under the SEBI FPI Regulations as any instrument, by whatever name called, which is issued overseas by an FPI against securities held by it that are listed or proposed to be listed on any recognized stock exchange in India, as its underlying) directly or indirectly, only in the event (i) such offshore derivative instruments are issued only to persons who are regulated by an appropriate regulatory authority; and (ii) such offshore derivative instruments are issued after compliance with know your client' norms. An FPI is also required to ensure that no further issue or



transfer of any offshore derivative instrument is made by or on behalf of it to any persons that are not regulated by an appropriate foreign regulatory authority.

FPIs who wish to participate in the Issue are advised to use the Application Form for Non-Residents (blue in colour).

Applications by SEBI registered VCFs, AIFs and FVCIs

The SEBI FVCI Regulations and the SEBI AIF Regulations inter-alia prescribe the investment restrictions on the VCFs, FVCIs and AIFs registered with SEBI. Further, the SEBI AIF Regulations prescribe, among others, the investment restrictions on AIFs.

The holding by any individual VCF registered with SEBI in one venture capital undertaking should not exceed 25% of the corpus of the VCF. Further, VCFs and FVCIs can invest only up to 33.33% of the investible funds by way of subscription to an initial public offering.

The category I and II AIFs cannot invest more than 25% of the corpus in one Investee Company. A category III AIF cannot invest more than 10% of the corpus in one Investee Company. A venture capital fund registered as a category I AIF, as defined in the SEBI AIF Regulations, cannot invest more than 1/3rd of its corpus by way of subscription to an initial public offering of a venture capital undertaking. Additionally, the VCFs which have not re-registered as an AIF under the SEBI AIF Regulations shall continue to be regulated by the VCF Regulation until the existing fund or scheme managed by the fund is wound up and such funds shall not launch any new scheme after the notification of the SEBI AIF Regulations.

All FIIs and FVCIs should note that refunds, dividends and other distributions, if any, will be payable in Indian Rupees only and net of Bank charges and commission.

Our Company or the Lead Manager will not be responsible for loss, if any, incurred by the Applicant on account of conversion of foreign currency.

There is no reservation for Eligible NRIs, FPIs and FVCIs and all Applicants will be treated on the same basis with other categories for the purpose of allocation.

Applications by Limited Liability Partnerships

In case of Applications made by limited liability partnerships registered under the Limited Liability Partnership Act, 2008, a certified copy of certificate of registration issued under the Limited Liability Partnership Act, 2008, must be attached to the Application Form. Failing this, our Company reserves the right to reject any Application without assigning any reason thereof.

Applications by Insurance Companies

In case of Applications made by insurance companies registered with the IRDA, a certified copy of certificate of registration issued by IRDA must be attached to the Application Form. Failing this, our Company reserves the right to reject any Application without assigning any reason thereof. The exposure norms for insurers, prescribed under the Insurance Regulatory and Development Authority (Investment) Regulations, 2000, as amended, are broadly set forth below:

- 1) equity shares of a company: the least of 10.00% of the investee company's subscribed capital (face value) or 10.00% of the respective fund in case of life insurer or 10.00% of investment assets in case of general insurer or reinsurer;



- 2) the entire group of the investee company: not more than 15% of the respective fund in case of a life insurer or 15% of investment assets in case of a general insurer or reinsurer or 15% of the investment assets in all companies belonging to the group, whichever is lower; and

the industry sector in which the investee company belong to: not more than 15% of the fund of a life insurer or a general insurer or a reinsurer or 15% of the investment asset, whichever is lower.

The maximum exposure limit, in the case of an investment in equity shares, cannot exceed the lower of an amount of 10% of the investment assets of a life insurer or general insurer and the amount calculated under (a), (b) and (c) above, as the case may be.

Insurance companies participating in this Issue shall comply with all applicable regulations, guidelines and circulars issued by IRDAI from time to time.

Applications by Provident Funds / Pension Funds

In case of Applications made by provident funds/pension funds, subject to applicable laws, with minimum corpus of ₹ 250.00 million, a certified copy of certificate from a chartered accountant certifying the corpus of the provident fund/ pension fund must be attached to the Application Form. Failing this, our Company reserves the right to reject any Application, without assigning any reason thereof.

Applications by Banking Companies

In case of Applications made by banking companies registered with RBI, certified copies of: (i) the certificate of registration issued by RBI, and (ii) the approval of such banking company's investment committee are required to be attached to the Application Form, failing which our Company reserve the right to reject any Application without assigning any reason.

The investment limit for banking companies as per the Banking Regulation Act, 1949, as amended, is 30.00% of the paid up share capital of the investee company or 30.00% of the banks' own paid up share capital and reserves, whichever is less (except in certain specified exceptions, such as setting up or investing in a subsidiary, which requires RBI approval).

Applications by SCSBs

SCSBs participating in the Issue are required to comply with the terms of the SEBI circulars dated September 13, 2012 and January 2, 2013. Such SCSBs are required to ensure that for making applications on their own account using ASBA, they should have a separate account in their own name with any other SEBI registered SCSBs. Further, such account shall be used solely for the purpose of making application in public issues and clear demarcated funds should be available in such account for such applications.

Applications under Power of Attorney

In case of Applications made pursuant to a power of attorney or by limited companies, corporate bodies, registered societies, FIIs, Mutual Funds, insurance companies and provident funds with a minimum corpus of ₹ 250 million (subject to applicable law) and pension funds with a minimum corpus of ₹ 250 million, a certified copy of the power of attorney or the relevant resolution or authority, as the case may be, along with a certified copy of the memorandum of association and articles of association and/or bye laws must be lodged along with the Application Form. Failing this, our Company reserves the right to accept or reject any Application in whole or in part, in either case, without assigning any reasons thereof. In addition to the above, certain additional documents are required to be submitted by the following entities:



- a) With respect to Applications by FIIs and Mutual Funds, a certified copy of their SEBI registration certificate must be lodged along with the Application Form.
- b) With respect to Applications by insurance companies registered with the Insurance Regulatory and Development Authority, in addition to the above, a certified copy of the certificate of registration issued by the Insurance Regulatory and Development Authority must be lodged along with the Application Form.
- c) With respect to Applications made by provident funds with a minimum corpus of ₹ 250 million (subject to applicable law) and pension funds with a minimum corpus of ₹ 250 million, a certified copy of a certificate from a chartered accountant certifying the corpus of the provident fund/pension fund must be lodged along with the Application Form.
- d) With respect to Applications made by limited liability partnerships registered under the Limited Liability Partnership Act, 2008, a certified copy of certificate of registration issued under the Limited Liability Partnership Act, 2008, must be attached to the Application Form.
- e) Our Company in its absolute discretion, reserves the right to relax the above condition of simultaneous lodging of the power of attorney along with the Application form, subject to such terms and conditions that our Company and the Lead Manager may deem fit.

The above information is given for the benefit of the Applicants. Our Company and the Lead Manager are not liable for any amendments or modification or changes in applicable laws or regulations, which may occur after the date of this Prospectus. Applicants are advised to make their independent investigations and Applicants are advised to ensure that any single Application from them does not exceed the applicable investment limits or maximum number of Equity Shares that can be held by them under applicable law or regulation or as specified in this Prospectus.

General Instructions

Do's:

- 1) Check if you are eligible to apply as per the terms of this Prospectus and under applicable law, rules, regulations, guidelines and approvals;
- 2) Read all the instructions carefully and complete the Application Form in the prescribed form;
- 3) Ensure that the details about the PAN, DP ID and Client ID are correct and the Applicants depository account is active, as Allotment of the Equity Shares will be in the dematerialised form only;
- 4) Ensure that your Application Form bearing the stamp of a Designated Intermediary is submitted to the Designated Intermediary;
- 5) If the first applicant is not the account holder, ensure that the Application Form is signed by the account holder. Ensure that you have mentioned the correct bank account number in the Application Form;
- 6) Ensure that the signature of the First Applicant in case of joint Applications, is included in the Application Forms;
- 7) Ensure that the name(s) given in the Application Form is/are exactly the same as the name(s) in which the beneficiary account is held with the Depository Participant. In case of joint Applications, the Application Form should contain only the name of the First Applicant whose name should also appear as the first holder of the beneficiary account held in joint names;



- 8) Ensure that you request for and receive a stamped acknowledgement of your Application;
- 9) Ensure that you have funds equal to the Application Amount in the ASBA Account maintained with the SCSB before submitting the Application Form under the ASBA process to the respective member of the SCSBs, the Registered Broker (at the Broker Centres), the RTA (at the Designated RTA Locations) or CDP (at the Designated CDP Locations);
- 10) Submit revised Applications to the same Designated Intermediary, through whom the original Application was placed and obtain a revised acknowledgment;
- 11) Except for Applications (i) on behalf of the Central or State Governments and the officials appointed by the courts, who, in terms of a SEBI circular dated June 30, 2008, may be exempt from specifying their PAN for transacting in the securities market, and (ii) Applications by persons resident in the state of Sikkim, who, in terms of a SEBI circular dated July 20, 2006, may be exempted from specifying their PAN for transacting in the securities market, all Applicants should mention their PAN allotted under the IT Act. The exemption for the Central or the State Government and officials appointed by the courts and for investors residing in the State of Sikkim is subject to (a) the Demographic Details received from the respective depositories confirming the exemption granted to the beneficiary owner by a suitable description in the PAN field and the beneficiary account remaining in "active status"; and (b) in the case of residents of Sikkim, the address as per the Demographic Details evidencing the same. All other applications in which PAN is not mentioned will be rejected;
- 12) Ensure that the Demographic Details are updated, true and correct in all respects;
- 13) Ensure that thumb impressions and signatures other than in the languages specified in the Eighth Schedule to the Constitution of India are attested by a Magistrate or a Notary Public or a Special Executive Magistrate under official seal;
- 14) Ensure that the category and the investor status is indicated;
- 15) Ensure that in case of Applications under power of attorney or by limited companies, corporates, trust etc., relevant documents are submitted;
- 16) Ensure that Applications submitted by any person outside India should be in compliance with applicable foreign and Indian laws;
- 17) Applicants should note that in case the DP ID, Client ID and the PAN mentioned in their Application Form and entered into the online IPO system of the Stock Exchanges by the relevant Designated Intermediary, as the case may be, do not match with the DP ID, Client ID and PAN available in the Depository database, then such Applications are liable to be rejected. Where the Application Form is submitted in joint names, ensure that the beneficiary account is also held in the same joint names and such names are in the same sequence in which they appear in the Application Form;
- 18) Ensure that the Application Forms are delivered by the Applicants within the time prescribed as per the Application Form and the Prospectus;
- 19) Ensure that you have mentioned the correct ASBA Account number in the Application Form;
- 20) Ensure that you have correctly signed the authorisation/undertaking box in the Application Form, or have otherwise provided an authorisation to the SCSB via the electronic mode, for blocking funds in the ASBA Account equivalent to the Application Amount mentioned in the Application Form at the time of submission of the Application;



- 21) Ensure that you receive an acknowledgement from the concerned Designated Intermediary, for the submission of your Application Form; and
- 22) The Application Form is liable to be rejected if the above instructions, as applicable, are not complied with.

Don'ts:

- 1) Do not apply for lower than the minimum Application size;
- 2) Do not apply at a Price different from the Price mentioned herein or in the Application Form;
- 3) Do not pay the Application Amount in cash, by money order, cheques or demand drafts or by postal order or by stock invest;
- 4) Do not send Application Forms by post; instead submit the same to the Designated Intermediary only;
- 5) Do not submit the Application Forms to any non-SCSB bank or our Company;
- 6) Do not apply on a Application Form that does not have the stamp of the relevant Designated Intermediary;
- 7) Do not instruct your respective Banks to release the funds blocked in the ASBA Account under the ASBA process;
- 8) Do not apply for a Application Amount exceeding ₹ 200,000 (for Applications by Retail Individual Applicants);
- 9) Do not fill up the Application Form such that the Equity Shares applied for exceeds the Issue size and / or investment limit or maximum number of the Equity Shares that can be held under the applicable laws or regulations or maximum amount permissible under the applicable regulations or under the terms of the Prospectus;
- 10) Do not submit the General Index Register number instead of the PAN;
- 11) Do not submit the Application without ensuring that funds equivalent to the entire Application Amount are blocked in the relevant ASBA Account;
- 12) Do not submit Applications on plain paper or on incomplete or illegible Application Forms or on Application Forms in a colour prescribed for another category of Applicant;
- 13) Do not submit a Application in case you are not eligible to acquire Equity Shares under applicable law or your relevant constitutional documents or otherwise;
- 14) Do not apply if you are not competent to contract under the Indian Contract Act, 1872 (other than minors having valid depository accounts as per Demographic Details provided by the depository);
- 15) Do not submit more than five Application Forms per ASBA Account;

The Application Form is liable to be rejected if the above instructions, as applicable, are not complied with.

Issuance of a Confirmation of Allocation Note (“CAN”) and Allotment in the Issue

1. Upon approval of the basis of allotment by the Designated Stock Exchange, the LM or Registrar to the Issue shall send to the SCSBs a list of their Applicants who have been allocated Equity Shares in the Issue.



2. The Registrar will then dispatch a CAN to their Applicants who have been allocated Equity Shares in the Issue. The dispatch of a CAN shall be deemed a valid, binding and irrevocable contract for the Applicant.

Payment instructions

The entire Issue price of ₹ 69/- per Equity Share is payable on Application. In case of allotment of lesser number of Equity Shares than the number applied, then the Registrar shall instruct the SCSBs to unblock the excess amount paid on Application to the Applicants.

SCSBs will transfer the amount as per the instruction received by the Registrar to the Public Issue Bank Account. The balance amount after transfer to the Public Issue Account shall be unblocked by the SCSBs.

The Applicants shall specify the bank account details in the Application Form and the SCSBs shall block an amount equivalent to the Application Amount in the bank account specified in the Application Form. The SCSB shall keep the Application Amount in the relevant bank account blocked until withdrawal / rejection of the application or receipt of instructions from the Registrar to unblock the Application Amount. However, Not Retails Applicants shall neither withdraw nor lower the size of their applications at any stage. In the event of withdrawal or rejection of the Application Form or for unsuccessful Application Forms, the Registrar to the Issue shall give instruction to the SCSBs to unblock the application money in the relevant bank account within one day of receipt of such instruction. The Application Amount shall remain blocked in the ASBA Account until finalisation of the Basis of Allotment in the Issue and consequent transfer of the Application Amount to the Public issue Account, or until withdrawal / failure of the Issue or until rejection of the application, as the case may be.

Pursuant to the SEBI (Issue of Capital and Disclosure Requirements) (Fifth Amendment) Regulations, 2015, the ASBA process become mandatory for all investors w.e.f. January 01, 2016 and it allows the registrar, share transfer agents, depository participants and stock brokers to accept application forms.

Electronic Registration of Applications

- 1) The Application Collecting Intermediary will register the applications using the on-line facilities of the Stock Exchange.
- 2) The Application Collecting Intermediary will undertake modification of selected fields in the application details already uploaded before 1.00 p.m. of the next Working day from the Issue Closing Date.
- 3) The Application Collecting Intermediary shall be responsible for any acts, mistakes or errors or omission and commissions in relation to, (i) the applications accepted by them, (ii) the applications uploaded by them, (iii) the applications accepted but not uploaded by them or (iv) In case the applications accepted and uploaded by any Application Collecting Intermediary other than SCSBs, the Application Form along with relevant schedules shall be sent to the SCSBs or the Designated Branch of the relevant SCSBs for blocking of funds and they will be responsible for blocking the necessary amounts in the ASBA Accounts. In case of Application accepted and uploaded by SCSBs, the SCSBs or the Designated Branch of the relevant SCSBs will be responsible for blocking the necessary amounts in the ASBA Accounts.
- 4) Neither the Lead Manager nor the Company, shall be responsible for any acts, mistakes or errors or omission and commissions in relation to, (i) the applications accepted by any Application Collecting Intermediaries, (ii) the applications uploaded by any Application Collecting Intermediaries or (iii) the applications accepted but not uploaded by the Application Collecting Intermediaries.
- 5) The Stock Exchange will Issue an electronic facility for registering applications for the Issue. This facility will be available at the terminals of the Application Collecting Intermediaries and their authorised agents during the



Issue Period. On the Issue Closing Date, the Application Collecting Intermediaries shall upload the applications till such time as may be permitted by the Stock Exchange.

- 6) With respect to applications by Applicants, at the time of registering such applications, the Application Collecting Intermediaries shall enter the following information pertaining to the Applicants into the on-line system:
 - Name of the Applicant;
 - IPO Name;
 - Application Form Number;
 - Investor Category;
 - PAN Number
 - DP ID & Client ID
 - Numbers of Equity Shares Applied for;
 - Amount;
 - Location of the Banker to the Issue or Designated Branch, as applicable;
 - Bank Account Number and
 - Such other information as may be required.
- 7) In case of submission of the Application by an Applicant through the Electronic Mode, the Applicant shall complete the above mentioned details and mentioned the bank account number, except the Electronic Application Form number which shall be system generated.
- 8) The aforesaid intermediaries shall, at the time of receipt of application, give an acknowledgement to investor, by giving the counter foil or specifying the application number to the investor, as a proof or having accepted the application form, in physical or electronic mode, respectively. The registration of the Application by the Application Collecting Intermediaries does not guarantee that the Equity Shares shall be allocated / allotted either by our Company.
- 9) Such acknowledgment will be non-negotiable and by itself will not create any obligation of any kind.
- 10) The Application Collecting Intermediaries shall have no right to reject the applications, except on technical grounds.
- 11) The permission given by the Stock Exchanges to use their network and software of the Online IPO system should not in any way deemed or construed to mean the compliance with various statutory and other requirements by our Company and / or the Lead Manager are cleared or approved by the Stock Exchanges; nor does it in any manner warrant, certify or endorse the correctness or completeness or any of the compliance with the statutory and other requirements nor does it take any responsibility for the financial or other soundness of our Company, our Promoter, our management or any scheme or project of our Company; nor does it in any manner warrant, certify or endorse the correctness or completeness of any of the contents of this Prospectus; not does it warrant that the Equity Shares will be listed or will continue to be listed on the Stock Exchange.
- 12) The Application Collecting Intermediaries will be given time till 1.00 p.m. on the next working day after the Issue Closing Date to verify the PAN No., DP ID and Client ID uploaded in the online IPO system during the Issue Period, after which the Registrar to the Issue will receive this data from the Stock Exchange and will validate the electronic application details with the Depository's records. In case no corresponding record is available with Depositories, which matches the three parameters, namely DP ID, Client ID and PAN, then such applications are liable to be rejected.
- 13) The details uploaded in the online IPO system shall be considered as final and Allotment will be based on such details for ASBA Applicants.



Allocation of Equity Shares

- 1) The Issue is being made through the Fixed Price Process wherein 72,000 Equity Shares shall be reserved for the Market Maker. 6,48,000 Equity Shares will be allocated on a proportionate basis to Retail Individual Applicants, subject to valid applications being received from the Retail Individual Applicants at the Issue Price. The balance of the Net Issue will be available for allocation on a proportionate basis to Non Retail Applicants.
- 2) Under-subscription, if any, in any category, would be allowed to be met with spill-over from any other category or combination of categories at the discretion of our Company in consultation with the Lead Manager and the Stock Exchange.
- 3) Allocation to Non-Residents, including Eligible NRIs, FIIs and FVCIs registered with SEBI, applying on repatriation basis will be subject to applicable law, rules, regulations, guidelines and approvals.
- 4) In terms of SEBI Regulations, Non Retail Applicants shall not be allowed to either withdraw or lower the size of their application at any stage.
- 5) Allotment status details shall be available on the website of the Registrar to the Issue.

Pre- Issue Advertisement

Subject to Section 30 of the Companies Act, our Company shall, after registering the Prospectus with the RoC, publish a pre- issue advertisement, in the form prescribed by the SEBI Regulations, in one English language national daily newspaper, one Hindi language national daily newspaper and one regional language daily newspaper, each with wide circulation. In the pre- issue advertisement, we shall state the Issue Opening Date and the Issue Closing Date. This advertisement, subject to the provisions of Section 30 of the Companies Act, 2013, shall be in the format prescribed in Part A of Schedule XIII of the SEBI Regulations.

Signing of the Underwriting Agreement and the RoC Filing

- a) Our Company, the Lead Manager and the Market Maker have entered into an Underwriting Agreement on March 22, 2018 and addendum dated June 12, 2018.
- b) For terms of the Underwriting Agreement please see chapter titled “*General Information*” beginning on page no. 52 of this Prospectus.
- c) We will file a copy of the Prospectus with the RoC in terms of Section 26, 28 and all other provision applicable as per Companies Act.

Communications

All future communications in connection with Applications made in this Issue should be addressed to the Registrar quoting the full name of the sole or First Applicant, Application Form number, Applicants Depository Account Details, number of Equity Shares applied for, date of Application Form, name and address of the SCSB / Designated Intermediary, where the Application was submitted and bank account number in which the amount equivalent to the Application Amount was blocked.

Applicants can contact the Compliance Officer or the Registrar in case of any pre- issue or post- issue related problems such as non-receipt of letters of Allotment, credit of allotted shares in the respective beneficiary accounts, refund orders etc. In case of ASBA Applications submitted to the Designated Branches of the SCSBs, the Applicants can contact the Designated Branches of the SCSBs.



Impersonation

Attention of the Applicants is specifically drawn to the provisions of sub-section (1) of Section 38 of the Companies Act, which is reproduced below:

“Any person who:

- a) makes or abets making of an application in a fictitious name to a company for acquiring, or subscribing for, its securities; or**
- b) makes or abets making of multiple applications to a company in different names or in different combinations of his name or surname for acquiring or subscribing for its securities; or**
- c) Otherwise induces directly or indirectly a company to allot, or register any transfer of, securities to him, or to any other person in a fictitious name, shall be liable for action under Section 447”**

The liability prescribed under Section 447 of the Companies Act, 2013 includes imprisonment for a term which shall not be less than six months extending up to 10 years (provided that where the fraud involves public interest, such term shall not be less than three years) and fine of an amount not less than the amount involved in the fraud, extending up to three times of such amount.

Undertaking by our Company

We undertake the following:

- 1) If our Company does not proceed with the Issue after the Issue Opening Date but before allotment, then the reason thereof shall be given as a public notice to be issued by our Company within two days of the Issue Closing Date. The public notice shall be issued in the same newspapers where the Pre- Issue advertisements were published. The stock exchanges on which the Equity Shares are proposed to be listed shall also be informed promptly;
- 2) If our Company withdraws the Issue after the Issue Closing Date, our Company shall be required to file a fresh offer document with the RoC/SEBI, in the event our Company subsequently decides to proceed with the Issue;
- 3) The complaints received in respect of the Issue shall be attended to by our Company expeditiously and satisfactorily;
- 4) All steps for completion of the necessary formalities for listing and commencement of trading at all the Stock Exchanges where the Equity Shares are proposed to be listed are taken within six Working Days of the Issue Closing Date;
- 5) The funds required for making refunds to unsuccessful applicants as per the mode(s) disclosed shall be made available to the Registrar and Share Transfer Agent to the Issue by our Company;
- 6) Allotment is not made within the prescribed time period under applicable law, the entire subscription amount received will be refunded/unblocked within the time prescribed under applicable law. If there is delay beyond the prescribed time, our Company shall pay interest prescribed under the Companies Act, 2013, the SEBI Regulations and applicable law for the delayed period;
- 7) Where refunds are made through electronic transfer of funds, as suitable communication shall be sent to the applicant within six Working Days from the Issue Closing Date, giving details of the bank where refunds shall be credited along with amount expected date of electronic credit of refund;



- 8) The certificates of the securities/refund orders to Eligible NRIs shall be dispatched within specified time;
- 9) No further Issue of Equity Shares shall be made till the Equity Shares issued through this Issue document are listed or until the Application monies are refunded / unblocked in ASBA Account on account of non-listing, under-subscription etc;
- 10) Adequate arrangements shall be made to collect all Application Forms and

Utilization of Issue Proceeds

The Board of Directors of our Company certifies that:

- 1) All monies received out of the Issue shall be credited/ transferred to a separate bank account other than the bank account referred to in sub section (3) of Section 40 of the Companies Act, 2013;
- 2) Details of all monies utilized out of the Issue shall be disclosed under an appropriate head in our balance sheet indicating the purpose for which such monies have been utilized under an appropriate separate head in the balance sheet of our Company indicating the purpose for which such monies have been utilised;
- 3) Details of all unutilized monies out of the Issue, if any shall be disclosed under the appropriate head in the balance sheet indicating the form in which such unutilized monies have been invested and
- 4) Our Company shall comply with the requirements of the SEBI (Listing Obligations and Disclosures Requirements) Regulations, 2015 in relation to the disclosure and monitoring of the utilization of the proceeds of the Issue.

Our Company shall not have recourse to the Issue Proceeds until the approval for listing and trading of the Equity Shares from the Stock Exchange where listing is sought has been received.



PART B

General Information Document for Investing in Public Issues

This General Information Document highlights the key rules, processes and procedures applicable to public issues in accordance with the provisions of the Companies Act, the SCRA, the SCRR and the SEBI ICDR Regulations. Bidders/Applicants should not construe the contents of this General Information Document as legal advice and should consult their own legal counsel and other advisors in relation to the legal matters concerning the issue. For taking an investment decision, the Bidders/Applicants should rely on their own examination of the Issuer and the Issue, and should carefully read the Prospectus before investing in the Issue.

SECTION 1: PURPOSE OF THE GENERAL INFORMATION DOCUMENT (GID)

This document is applicable to the public issues undertaken through the Book-Building Process as well as to the Fixed Price Issues. The purpose of the “General Information Document for Investing in Public Issues” is to provide general guidance to potential Bidders/Applicants in IPOs and FPOs, and on the processes and procedures governing IPOs and FPOs, undertaken in accordance with the provisions of the Securities and Exchange Board of India (Issue of Capital and Disclosure Requirements) Regulations, 2009 (“**SEBI ICDR Regulations, 2009**”).

Bidders/Applicants should note that investment in equity and equity related securities involves risk and Bidder/Applicant should not invest any funds in the Issue unless they can afford to take the risk of losing their investment. The specific terms relating to securities and/or for subscribing to securities in an Issue and the relevant information about the Issuer undertaking the Issue are set out in the Prospectus filed by the Issuer with the Registrar of Companies (“RoC”). Applicants should carefully read the entire Prospectus and the Bid cum Application Form/Application Form and the Abridged Prospectus of the Issuer in which they are proposing to invest through the Issue. In case of any difference in interpretation or conflict and/or overlap between the disclosure included in this document and the Prospectus, the disclosures in the Prospectus shall prevail. The Prospectus of the Issuer is available on the websites of stock exchanges, on the website(s) of the BRLM(s) to the Issue and on the website of Securities and Exchange Board of India (“SEBI”) at www.sebi.gov.in.

For the definitions of capitalized terms and abbreviations used herein Bidders/Applicants may see “*Glossary and Abbreviations*”.

SECTION 2: BRIEF INTRODUCTION TO IPOs/FPOs

2.1 Initial public offer (IPO)

An IPO means an offer of specified securities by an unlisted Issuer to the public for subscription and may include an Offer for Sale of specified securities to the public by any existing holder of such securities in an unlisted Issuer.

For undertaking an IPO, an Issuer is *inter-alia* required to comply with the eligibility requirements of in terms of either Regulation 26(1) or Regulation 26(2) of the SEBI ICDR Regulations, 2009. For details of compliance with the eligibility requirements by the Issuer, Bidders/Applicants may refer to the Prospectus.

2.2 Further public offer (FPO)

An FPO means an Issue of specified securities by a listed Issuer to the public for subscription and may include Offer for Sale of specified securities to the public by any existing holder of such securities in a listed Issuer.

For undertaking an FPO, the Issuer is *inter-alia* required to comply with the eligibility requirements in terms of Regulation 26/ Regulation 27 of the SEBI ICDR Regulations, 2009. For details of compliance with the eligibility requirements by the Issuer, Bidders/Applicants may refer to the Prospectus.



2.3 Other Eligibility Requirements:

In addition to the eligibility requirements specified in paragraphs 2.1 and 2.2, an Issuer proposing to undertake an IPO or an FPO is required to comply with various other requirements as specified in the SEBI ICDR Regulations, 2009, the Companies Act, 2013, the Companies Act, 1956 (to the extent applicable), the Securities Contracts (Regulation) Rules, 1957 (the “SCR”), industry-specific regulations, if any, and other applicable laws for the time being in force.

For details in relation to the above Applicants may refer to the Prospectus.

2.4 Types of Public Issues – Fixed Price Issues and Book Built Issues

In accordance with the provisions of the SEBI ICDR Regulations, 2009, an Issuer can either determine the Issue Price through the Book Building Process (“Book Built Issue”) or undertake a Fixed Price Issue (“Fixed Price Issue”). An Issuer may mention Floor Price or Price Band in the RHP (in case of a Book Built Issue) and a Price or Price Band in the Prospectus (in case of a fixed price Issue) and determine the price at a later date before registering the Prospectus with the Registrar of Companies.

The cap on the Price Band should be less than or equal to 120% of the Floor Price. The Issuer shall announce the Price or the Floor Price or the Price Band through advertisement in all newspapers in which the pre-issue advertisement was given at least five Working Days before the Bid/Issue Opening Date, in case of an IPO and at least one Working Day before the Bid/Issue Opening Date, in case of an FPO.

The Floor Price or the Issue price cannot be lesser than the face value of the securities.

Applicants should refer to the Prospectus or Issue advertisements to check whether the Issue is a Book Built Issue or a Fixed Price Issue.

2.5 ISSUE PERIOD

The Issue may be kept open for a minimum of three Working Days (for all category of Applicants) and not more than ten Working Days. Applicants are advised to refer to the Bid cum Application Form and Abridged Prospectus or Prospectus for details of the Bid/ Issue Period. Details of Bid/ Issue Period are also available on the website of the Stock Exchange(s).

In case of a Book Built Issue, the Issuer may close the Bid/ Issue Period for QIBs one Working Day prior to the Bid/ Issue Closing Date if disclosures to that effect are made in the Prospectus. In case of revision of the Floor Price or Price Band in Book Built Issues the Bid/ Issue Period may be extended by at least three Working Days, subject to the total Bid/ Issue Period not exceeding 10 Working Days. For details of any revision of the Floor Price or Price Band, Applicants may check the announcements made by the Issuer on the websites of the Stock Exchanges and the BRLM(s), and the advertisement in the newspaper(s) issued in this regard.

2.6 FLOWCHART OF TIMELINES

A flow chart of process flow in Fixed Price and Book Built Issues is as follows. Applicants may note that this is not applicable for Fast Track FPOs:

In case of Issue other than Book Built Issue (Fixed Price Issue) the process at the following of the below mentioned steps shall be read as:

- i. Step 7 : Determination of Issue Date and Price
- ii. Step 10: Applicant submits Bid cum Application Form with Designated Branch of SCSB.

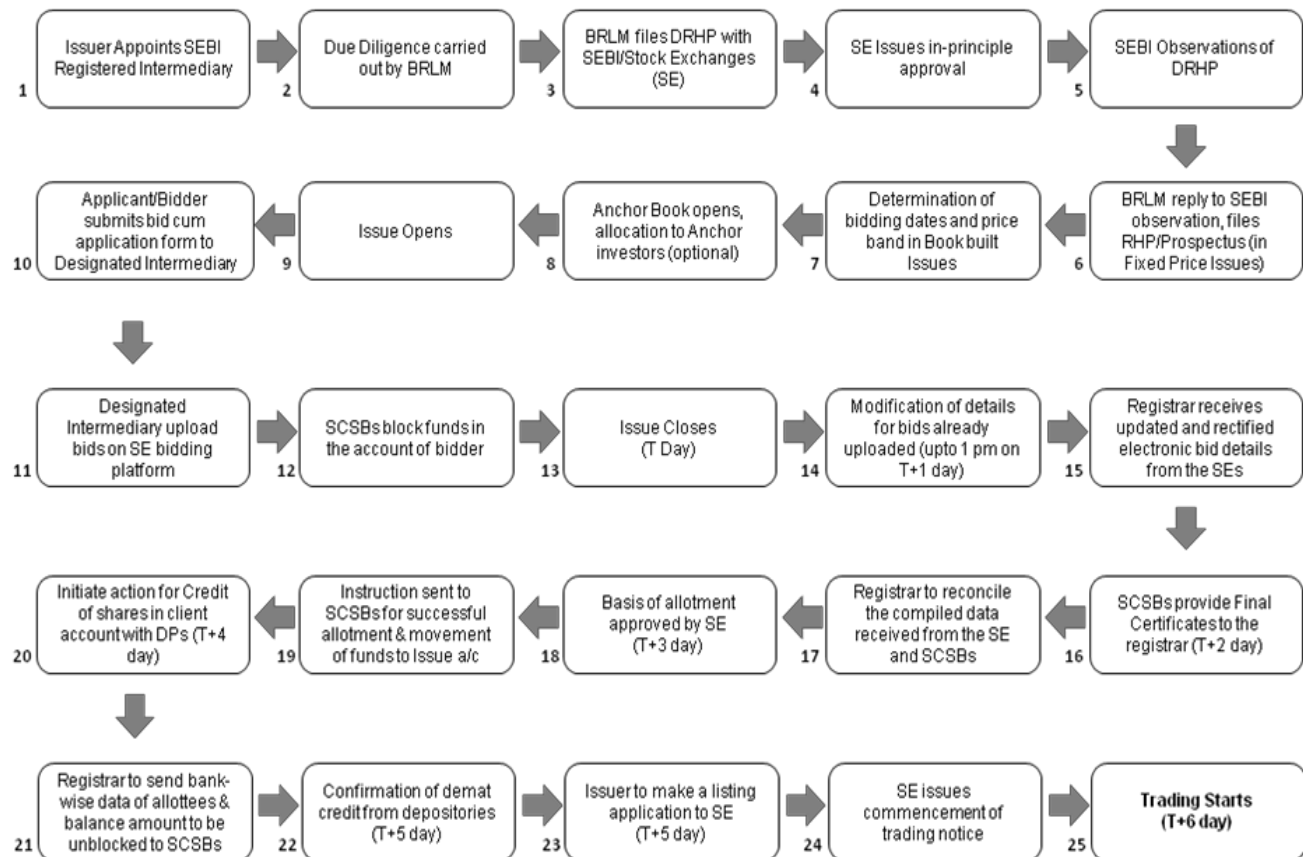

SECTION 3: CATEGORY OF INVESTORS ELIGIBLE TO PARTICIPATE IN AN ISSUE

Each Applicant should check whether it is eligible to apply under applicable law. Furthermore, certain categories of Applicants, such as NRIs, FIIs, FPIs and FVCIs may not be allowed to Bid/Apply in the Issue or to hold Equity Shares, in excess of certain limits specified under applicable law. Applicants are requested to refer to the Prospectus for more details.

Subject to the above, an illustrative list of Applicants is as follows:

- Indian nationals resident in India who are competent to contract under the Indian Contract Act, 1872, in single or joint names (not more than three);
- Bids/Applications belonging to an account for the benefit of a minor (under guardianship);
- Hindu Undivided Families or HUFs, in the individual name of the *Karta*. The Applicant should specify that the Bid is being made in the name of the HUF in the Bid cum Application Form/Application Form as follows: “Name of sole or first Applicant: XYZ Hindu Undivided Family applying through XYZ, where XYZ is the name of the *Karta*”. Bids/Applications by HUFs may be considered at par with Bids/Applications from individuals;
- Companies, corporate bodies and societies registered under applicable law in India and authorised to invest in equity shares;



- QIBs;
- NRIs on a repatriation basis or on a non-repatriation basis, subject to applicable law;
- Indian Financial Institutions, regional rural banks, co-operative banks (subject to RBI regulations and the SEBI ICDR Regulations, 2009 and other laws, as applicable);
- FIIs and sub-accounts registered with SEBI, other than a sub-account which is a foreign corporate or foreign individual, bidding under the QIBs category;
- Sub-accounts of FIIs registered with SEBI, which are foreign corporates or foreign individuals Bidding only under the Non Institutional Investors (“**NII**s”) category;
- FPIs other than Category III foreign portfolio investors, Bidding under the QIBs category;
- FPIs which are Category III foreign portfolio investors, Bidding under the NIIIs category;
- Trusts/societies registered under the Societies Registration Act, 1860, or under any other law relating to trusts/societies and who are authorised under their respective constitutions to hold and invest in equity shares;
- Limited liability partnerships registered under the Limited Liability Partnership Act, 2008; and
- Any other person eligible to Bid/Apply in the Issue, under the laws, rules, regulations, guidelines and policies applicable to them and under Indian laws.
- As per the existing regulations, OCBs are not allowed to participate in an Issue.

SECTION 4: APPLYING IN THE ISSUE

Book Built Issue: Bidders should only use the specified ASBA Form (or in case of Anchor Investors, the Anchor Investor Application Form) either bearing the stamp of a member of the Syndicate or any other Designated Intermediary, as available or downloaded from the websites of the Stock Exchanges. Bid cum Application Forms are available with the Book Running Lead Managers, the Designated Intermediaries at the Bidding Centres and at the registered office of the Issuer. Electronic Bid cum Application Forms will be available on the websites of the Stock Exchanges at least one day prior to the Bid/ Issue Opening Date. For further details, regarding availability of Bid cum Application Forms, Bidders may refer to the Prospectus.

Fixed Price Issue: Applicants should only use the specified cum Application Form bearing the stamp of an SCSB as available or downloaded from the websites of the Stock Exchanges. Application Forms are available with the Designated Branches of the SCSBs and at the Registered and Corporate Office of the Issuer. For further details, regarding availability of Application Forms, Applicants may refer to the Prospectus.

Applicants should ensure that they apply in the appropriate category. The prescribed color of the Bid cum Application Form for various categories of Applicants is as follows:

Category	Colour⁽¹⁾
Resident Indians and Eligible NRIs applying on a non-repatriation basis	White
Non-Residents and Eligible NRIs, FIIs, FVCIs, etc. applying on a repatriation basis	Blue

⁽¹⁾ excluding electronic Application Form



Securities issued in an IPO can only be in dematerialized form in accordance with Section 29 of the Companies Act, 2013. Applicants will not have the option of getting the Allotment of specified securities in physical form. However, they may get the specified securities rematerialised subsequent to Allotment.

4.1 INSTRUCTIONS FOR FILING THE BID CUM APPLICATION FORM/APPLICATION FORM

Applicants may note that forms not filled completely or correctly as per instructions provided in this GID, the Prospectus and the Bid cum Application Form/Application Form are liable to be rejected.

Instructions to fill each field of the Bid cum Application Form can be found on the reverse side of the Bid cum Application Form. Specific instructions for filling various fields of the Bid cum Application Form and sample are provided below.



A sample Bid cum Application Form is reproduced below:

<p style="writing-mode: vertical-rl; transform: rotate(180deg);">TEAR HERE</p>	COMMON BID CUM APPLICATION FORM	XYZ LIMITED - INITIAL PUBLIC ISSUE - R Address : Contact Details: CIN No	FOR RESIDENT INDIANS, INCLUDING RESIDENT QIBs AND ELIGIBLE NRI, APPLYING ON A NON-REPATRIATION BASIS																																																				
<p style="writing-mode: vertical-rl; transform: rotate(180deg);">PLEASE FILL IN BLOCK LETTERS</p>	LOGO TO, THE BOARD OF DIRECTORS XYZ LIMITED	<div style="border: 1px solid black; padding: 2px; display: inline-block;"> BOOK BUILT ISSUE </div> <div style="border: 1px solid black; padding: 2px; display: inline-block;"> ISIN : </div>	Bid cum Application Form No. 																																																				
<p style="writing-mode: vertical-rl; transform: rotate(180deg);">TEAR HERE</p>	<table border="1" style="width:100%; border-collapse: collapse;"> <tr> <td style="width:25%;">SYNDICATE MEMBER'S STAMP & CODE</td> <td style="width:25%;">BROKER/SCSB/DP/RTA STAMP & CODE</td> </tr> <tr> <td style="width:25%;">SUB-BROKER'S / SUB-AGENT'S STAMP & CODE</td> <td style="width:25%;">ESCROW BANK/SCSB BRANCH STAMP & CODE</td> </tr> <tr> <td>BANK BRANCH SERIAL NO.</td> <td>SCSB SERIAL NO.</td> </tr> </table>	SYNDICATE MEMBER'S STAMP & CODE	BROKER/SCSB/DP/RTA STAMP & CODE	SUB-BROKER'S / SUB-AGENT'S STAMP & CODE	ESCROW BANK/SCSB BRANCH STAMP & CODE	BANK BRANCH SERIAL NO.	SCSB SERIAL NO.	<table border="1" style="width:100%; border-collapse: collapse;"> <tr> <td colspan="4">1. NAME & CONTACT DETAILS OF SOLE / FIRST BIDDER</td> </tr> <tr> <td colspan="4">Mr. / Ms. </td> </tr> <tr> <td colspan="4">Address </td> </tr> <tr> <td colspan="2">Tel. No (with STD code) / Mobile </td> <td colspan="2">Email </td> </tr> <tr> <td colspan="4">2. PAN OF SOLE / FIRST BIDDER</td> </tr> <tr> <td colspan="4"></td> </tr> </table>		1. NAME & CONTACT DETAILS OF SOLE / FIRST BIDDER				Mr. / Ms. 				Address 				Tel. No (with STD code) / Mobile 		Email 		2. PAN OF SOLE / FIRST BIDDER																													
SYNDICATE MEMBER'S STAMP & CODE	BROKER/SCSB/DP/RTA STAMP & CODE																																																						
SUB-BROKER'S / SUB-AGENT'S STAMP & CODE	ESCROW BANK/SCSB BRANCH STAMP & CODE																																																						
BANK BRANCH SERIAL NO.	SCSB SERIAL NO.																																																						
1. NAME & CONTACT DETAILS OF SOLE / FIRST BIDDER																																																							
Mr. / Ms. 																																																							
Address 																																																							
Tel. No (with STD code) / Mobile 		Email 																																																					
2. PAN OF SOLE / FIRST BIDDER																																																							
																																																							
<p style="writing-mode: vertical-rl; transform: rotate(180deg);">TEAR HERE</p>	<table border="1" style="width:100%; border-collapse: collapse;"> <tr> <td colspan="2">3. BIDDER'S DEPOSITORY ACCOUNT DETAILS</td> <td colspan="2"><input type="checkbox"/> NSDL <input type="checkbox"/> CDSL</td> </tr> <tr> <td colspan="4">For NSDL, enter 8 digit DP ID followed by 3 digit Client ID / For CDSL, enter 16 digit Client ID</td> </tr> </table>		3. BIDDER'S DEPOSITORY ACCOUNT DETAILS		<input type="checkbox"/> NSDL <input type="checkbox"/> CDSL		For NSDL, enter 8 digit DP ID followed by 3 digit Client ID / For CDSL, enter 16 digit Client ID				<table border="1" style="width:100%; border-collapse: collapse;"> <tr> <td colspan="2">6. INVESTOR STATUS</td> </tr> <tr> <td colspan="2"><input type="checkbox"/> Individual(s) - IND</td> </tr> <tr> <td colspan="2"><input type="checkbox"/> Hindu Undivided Family* - HUF</td> </tr> <tr> <td colspan="2"><input type="checkbox"/> Bodies Corporate - CO</td> </tr> <tr> <td colspan="2"><input type="checkbox"/> Banks & Financial Institutions - FI</td> </tr> <tr> <td colspan="2"><input type="checkbox"/> Mutual Funds - MF</td> </tr> <tr> <td colspan="2"><input type="checkbox"/> Non-Resident Indians - NRI (Non-Repatriation basis)</td> </tr> <tr> <td colspan="2"><input type="checkbox"/> National Investment Fund - NIF</td> </tr> <tr> <td colspan="2"><input type="checkbox"/> Insurance Funds - IF</td> </tr> <tr> <td colspan="2"><input type="checkbox"/> Insurance Companies - IC</td> </tr> <tr> <td colspan="2"><input type="checkbox"/> Venture Capital Funds - VCF</td> </tr> <tr> <td colspan="2"><input type="checkbox"/> Alternative Investment Funds - AIF</td> </tr> <tr> <td colspan="2"><input type="checkbox"/> Others (Please specify) - OTH</td> </tr> </table> <p><small>* HUF should apply only through Karta (Application by HUF would be treated on par with Individual)</small></p>	6. INVESTOR STATUS		<input type="checkbox"/> Individual(s) - IND		<input type="checkbox"/> Hindu Undivided Family* - HUF		<input type="checkbox"/> Bodies Corporate - CO		<input type="checkbox"/> Banks & Financial Institutions - FI		<input type="checkbox"/> Mutual Funds - MF		<input type="checkbox"/> Non-Resident Indians - NRI (Non-Repatriation basis)		<input type="checkbox"/> National Investment Fund - NIF		<input type="checkbox"/> Insurance Funds - IF		<input type="checkbox"/> Insurance Companies - IC		<input type="checkbox"/> Venture Capital Funds - VCF		<input type="checkbox"/> Alternative Investment Funds - AIF		<input type="checkbox"/> Others (Please specify) - OTH																			
3. BIDDER'S DEPOSITORY ACCOUNT DETAILS		<input type="checkbox"/> NSDL <input type="checkbox"/> CDSL																																																					
For NSDL, enter 8 digit DP ID followed by 3 digit Client ID / For CDSL, enter 16 digit Client ID																																																							
6. INVESTOR STATUS																																																							
<input type="checkbox"/> Individual(s) - IND																																																							
<input type="checkbox"/> Hindu Undivided Family* - HUF																																																							
<input type="checkbox"/> Bodies Corporate - CO																																																							
<input type="checkbox"/> Banks & Financial Institutions - FI																																																							
<input type="checkbox"/> Mutual Funds - MF																																																							
<input type="checkbox"/> Non-Resident Indians - NRI (Non-Repatriation basis)																																																							
<input type="checkbox"/> National Investment Fund - NIF																																																							
<input type="checkbox"/> Insurance Funds - IF																																																							
<input type="checkbox"/> Insurance Companies - IC																																																							
<input type="checkbox"/> Venture Capital Funds - VCF																																																							
<input type="checkbox"/> Alternative Investment Funds - AIF																																																							
<input type="checkbox"/> Others (Please specify) - OTH																																																							
<p style="writing-mode: vertical-rl; transform: rotate(180deg);">TEAR HERE</p>	<table border="1" style="width:100%; border-collapse: collapse;"> <tr> <td colspan="4">4. BID OPTIONS (ONLY RETAIL INDIVIDUAL BIDDERS CAN BID AT "CUT-OFF")</td> <td colspan="2">5. CATEGORY</td> </tr> <tr> <td rowspan="2">Bid Options</td> <td colspan="3">No. of Equity Shares Bid (In Figures) <small>(Bids must be in multiples of Bid Lot as advertised)</small></td> <td colspan="2">Price per Equity Share (₹) / "Cut-off" <small>(Price in multiples of ₹ 1/- only) (In Figures)</small></td> </tr> <tr> <td></td> <td>Bid Price</td> <td>Retail Discount</td> <td>Net Price</td> <td>"Cut-off" (Please tick)</td> </tr> <tr> <td>Option 1</td> <td></td> <td></td> <td></td> <td></td> <td><input type="checkbox"/></td> </tr> <tr> <td>(OR) Option 2</td> <td></td> <td></td> <td></td> <td></td> <td><input type="checkbox"/></td> </tr> <tr> <td>(OR) Option 3</td> <td></td> <td></td> <td></td> <td></td> <td><input type="checkbox"/></td> </tr> </table>		4. BID OPTIONS (ONLY RETAIL INDIVIDUAL BIDDERS CAN BID AT "CUT-OFF")				5. CATEGORY		Bid Options	No. of Equity Shares Bid (In Figures) <small>(Bids must be in multiples of Bid Lot as advertised)</small>			Price per Equity Share (₹) / "Cut-off" <small>(Price in multiples of ₹ 1/- only) (In Figures)</small>			Bid Price	Retail Discount	Net Price	"Cut-off" (Please tick)	Option 1					<input type="checkbox"/>	(OR) Option 2					<input type="checkbox"/>	(OR) Option 3					<input type="checkbox"/>	<table border="1" style="width:100%; border-collapse: collapse;"> <tr> <td colspan="2">7. PAYMENT DETAILS</td> <td colspan="2">PAYMENT OPTION : FULL PAYMENT <input type="checkbox"/> PART PAYMENT <input type="checkbox"/></td> </tr> <tr> <td colspan="4">Amount paid (₹ in figures) (₹ in words) _____</td> </tr> <tr> <td colspan="4">ASBA Bank A/c No. </td> </tr> <tr> <td colspan="4">Bank Name & Branch </td> </tr> </table>		7. PAYMENT DETAILS		PAYMENT OPTION : FULL PAYMENT <input type="checkbox"/> PART PAYMENT <input type="checkbox"/>		Amount paid (₹ in figures) (₹ in words) _____				ASBA Bank A/c No. 				Bank Name & Branch 			
4. BID OPTIONS (ONLY RETAIL INDIVIDUAL BIDDERS CAN BID AT "CUT-OFF")				5. CATEGORY																																																			
Bid Options	No. of Equity Shares Bid (In Figures) <small>(Bids must be in multiples of Bid Lot as advertised)</small>			Price per Equity Share (₹) / "Cut-off" <small>(Price in multiples of ₹ 1/- only) (In Figures)</small>																																																			
		Bid Price	Retail Discount	Net Price	"Cut-off" (Please tick)																																																		
Option 1					<input type="checkbox"/>																																																		
(OR) Option 2					<input type="checkbox"/>																																																		
(OR) Option 3					<input type="checkbox"/>																																																		
7. PAYMENT DETAILS		PAYMENT OPTION : FULL PAYMENT <input type="checkbox"/> PART PAYMENT <input type="checkbox"/>																																																					
Amount paid (₹ in figures) (₹ in words) _____																																																							
ASBA Bank A/c No. 																																																							
Bank Name & Branch 																																																							
<p style="writing-mode: vertical-rl; transform: rotate(180deg);">TEAR HERE</p>	<table border="1" style="width:100%; border-collapse: collapse;"> <tr> <td colspan="2">8A. SIGNATURE OF SOLE / FIRST BIDDER</td> <td colspan="2">8B. SIGNATURE OF ASBA BANK ACCOUNT HOLDER(S) (AS PER BANK RECORDS)</td> <td colspan="2">BROKER / SCSB / DP / RTA STAMP (Acknowledging upload of Bid in Stock Exchange system)</td> </tr> <tr> <td colspan="2" rowspan="3"></td> <td colspan="2">I/We authorize the SCSB to do all acts as are necessary to make the Application in the line</td> <td colspan="2" rowspan="3"></td> </tr> <tr> <td colspan="2">1) </td> </tr> <tr> <td colspan="2">2) </td> </tr> <tr> <td colspan="2">Date: _____</td> <td colspan="2">3) </td> <td colspan="2"></td> </tr> </table>		8A. SIGNATURE OF SOLE / FIRST BIDDER		8B. SIGNATURE OF ASBA BANK ACCOUNT HOLDER(S) (AS PER BANK RECORDS)		BROKER / SCSB / DP / RTA STAMP (Acknowledging upload of Bid in Stock Exchange system)				I/We authorize the SCSB to do all acts as are necessary to make the Application in the line				1) 		2) 		Date: _____		3) 				<table border="1" style="width:100%; border-collapse: collapse;"> <tr> <td colspan="2">8A. SIGNATURE OF SOLE / FIRST BIDDER</td> <td colspan="2">8B. SIGNATURE OF ASBA BANK ACCOUNT HOLDER(S) (AS PER BANK RECORDS)</td> <td colspan="2">BROKER / SCSB / DP / RTA STAMP (Acknowledging upload of Bid in Stock Exchange system)</td> </tr> <tr> <td colspan="2" rowspan="3"></td> <td colspan="2">I/We authorize the SCSB to do all acts as are necessary to make the Application in the line</td> <td colspan="2" rowspan="3"></td> </tr> <tr> <td colspan="2">1) </td> </tr> <tr> <td colspan="2">2) </td> </tr> <tr> <td colspan="2">Date: _____</td> <td colspan="2">3) </td> <td colspan="2"></td> </tr> </table>		8A. SIGNATURE OF SOLE / FIRST BIDDER		8B. SIGNATURE OF ASBA BANK ACCOUNT HOLDER(S) (AS PER BANK RECORDS)		BROKER / SCSB / DP / RTA STAMP (Acknowledging upload of Bid in Stock Exchange system)				I/We authorize the SCSB to do all acts as are necessary to make the Application in the line				1) 		2) 		Date: _____		3) 										
8A. SIGNATURE OF SOLE / FIRST BIDDER		8B. SIGNATURE OF ASBA BANK ACCOUNT HOLDER(S) (AS PER BANK RECORDS)		BROKER / SCSB / DP / RTA STAMP (Acknowledging upload of Bid in Stock Exchange system)																																																			
		I/We authorize the SCSB to do all acts as are necessary to make the Application in the line																																																					
		1) 																																																					
		2) 																																																					
Date: _____		3) 																																																					
8A. SIGNATURE OF SOLE / FIRST BIDDER		8B. SIGNATURE OF ASBA BANK ACCOUNT HOLDER(S) (AS PER BANK RECORDS)		BROKER / SCSB / DP / RTA STAMP (Acknowledging upload of Bid in Stock Exchange system)																																																			
		I/We authorize the SCSB to do all acts as are necessary to make the Application in the line																																																					
		1) 																																																					
		2) 																																																					
Date: _____		3) 																																																					
<p style="writing-mode: vertical-rl; transform: rotate(180deg);">TEAR HERE</p>	<table border="1" style="width:100%; border-collapse: collapse;"> <tr> <td colspan="2" style="background-color: #0056b3; color: white; text-align: center;">XYZ LIMITED</td> <td colspan="2" style="background-color: #0056b3; color: white; text-align: center;">Acknowledgement Slip for Broker/SCSB/DP/RTA</td> <td colspan="2" style="background-color: #0056b3; color: white; text-align: center;">XYZ LIMITED - INITIAL PUBLIC ISSUE - R</td> </tr> <tr> <td colspan="2">LOGO</td> <td colspan="2">PAN of Sole / First Bidder </td> <td colspan="2">Bid cum Application Form No. </td> </tr> <tr> <td colspan="2">DPID / CLID </td> <td colspan="2">Amount paid (₹ in figures) Bank & Branch </td> <td colspan="2">ASBA Bank A/c No. </td> </tr> <tr> <td colspan="2">Received from Mr./Ms. </td> <td colspan="2">Telephone / Mobile Email </td> <td colspan="2">Stamp & Signature of SCSB Branch </td> </tr> </table>		XYZ LIMITED		Acknowledgement Slip for Broker/SCSB/DP/RTA		XYZ LIMITED - INITIAL PUBLIC ISSUE - R		LOGO		PAN of Sole / First Bidder 		Bid cum Application Form No. 		DPID / CLID 		Amount paid (₹ in figures) Bank & Branch 		ASBA Bank A/c No. 		Received from Mr./Ms. 		Telephone / Mobile Email 		Stamp & Signature of SCSB Branch 		<table border="1" style="width:100%; border-collapse: collapse;"> <tr> <td colspan="2" style="background-color: #0056b3; color: white; text-align: center;">XYZ LIMITED - INITIAL PUBLIC ISSUE - R</td> <td colspan="2" style="background-color: #0056b3; color: white; text-align: center;">Acknowledgement Slip for Bidder</td> </tr> <tr> <td colspan="2">No. of Equity Shares</td> <td colspan="2">Name of Sole / First Bidder </td> </tr> <tr> <td colspan="2">Bid Price</td> <td colspan="2" rowspan="2">Stamp & Signature of Broker / SCSB / DP / RTA </td> </tr> <tr> <td colspan="2">Amount Paid (₹)</td> </tr> <tr> <td colspan="2">ASBA Bank A/c No. </td> <td colspan="2" rowspan="2">Bid cum Application Form No. </td> </tr> <tr> <td colspan="2">Bank & Branch </td> </tr> </table>		XYZ LIMITED - INITIAL PUBLIC ISSUE - R		Acknowledgement Slip for Bidder		No. of Equity Shares		Name of Sole / First Bidder 		Bid Price		Stamp & Signature of Broker / SCSB / DP / RTA 		Amount Paid (₹)		ASBA Bank A/c No. 		Bid cum Application Form No. 		Bank & Branch 								
XYZ LIMITED		Acknowledgement Slip for Broker/SCSB/DP/RTA		XYZ LIMITED - INITIAL PUBLIC ISSUE - R																																																			
LOGO		PAN of Sole / First Bidder 		Bid cum Application Form No. 																																																			
DPID / CLID 		Amount paid (₹ in figures) Bank & Branch 		ASBA Bank A/c No. 																																																			
Received from Mr./Ms. 		Telephone / Mobile Email 		Stamp & Signature of SCSB Branch 																																																			
XYZ LIMITED - INITIAL PUBLIC ISSUE - R		Acknowledgement Slip for Bidder																																																					
No. of Equity Shares		Name of Sole / First Bidder 																																																					
Bid Price		Stamp & Signature of Broker / SCSB / DP / RTA 																																																					
Amount Paid (₹)																																																							
ASBA Bank A/c No. 		Bid cum Application Form No. 																																																					
Bank & Branch 																																																							



4.1.1 FIELD NUMBER 1: NAME AND CONTACT DETAILS OF THE SOLE / FIRST BIDDER / APPLICANT

- a) Applicants should ensure that the name provided in this field is exactly the same as the name in which the Depository Account is held.
- b) **Mandatory Fields:** Applicants should note that the name and address fields are compulsory and e-mail and/or telephone number/mobile number fields are optional. Applicants should note that the contact details mentioned in the Bid cum Application Form/Application Form may be used to dispatch communications (including letters notifying the unblocking of the bank accounts of Applicants) in case the communication sent to the address available with the Depositories are returned undelivered or are not available. The contact details provided in the Bid cum Application Form may be used by the Issuer, the Designated Intermediaries and the Registrar to the Issue only for correspondence(s) related to an Issue and for no other purposes.
- c) **Joint Bids/Applications:** In the case of Joint Bids/Applications, the Bids/Applications should be made in the name of the Applicant whose name appears first in the Depository account. The name so entered should be the same as it appears in the Depository records. The signature of only such first Applicant would be required in the Bid cum Application Form/Application Form and such first Applicant would be deemed to have signed on behalf of the joint holders. All communications may be addressed to such Applicant and may be dispatched to his or her address as per the Demographic Details received from the Depositories.
- d) **Impersonation:** Attention of the Applicants is specifically drawn to the provisions of sub-section (1) of Section 38 of the Companies Act, 2013 which is reproduced below:

“Any person who:

- *makes or abets making of an application in a fictitious name to a company for acquiring, or subscribing for, its securities; or*
- *makes or abets making of multiple applications to a company in different names or in different combinations of his name or surname for acquiring or subscribing for its securities; or*
- *otherwise induces directly or indirectly a company to allot, or register any transfer of, securities to him, or to any other person in a fictitious name, shall be liable for action under Section 447.”*

The liability prescribed under Section 447 of the Companies Act, 2013 includes imprisonment for a term which shall not be less than six months extending up to 10 years (provided that where the fraud involves public interest, such term shall not be less than three years) and fine of an amount not less than the amount involved in the fraud, extending up to three times of such amount.

- e) **Nomination Facility to Applicant:** Nomination facility is available in accordance with the provisions of Section 72 of the Companies Act, 2013. In case of Allotment of the Equity Shares in dematerialized form, there is no need to make a separate nomination as the nomination registered with the Depository may prevail. For changing nominations, the Applicants should inform their respective DP.

4.1.2 FIELD NUMBER 2: PAN NUMBER OF SOLE/FIRST APPLICANT

- a) PAN (of the sole/first Applicant) provided in the Bid cum Application Form/Application Form should be exactly the same as the PAN of the person(s) in whose name the relevant beneficiary account is held as per the Depositories' records.



- b) PAN is the sole identification number for participants transacting in the securities market irrespective of the amount of transaction except for Bids/Applications on behalf of the Central or State Government, Bids/Applications by officials appointed by the courts and Bids/Applications by Applicants residing in Sikkim (“PAN Exempted Applicants”). Consequently, all Applicants, other than the PAN Exempted Applicants, are required to disclose their PAN in the Bid cum Application Form/Application Form, irrespective of the Bid/Application Amount. Bids/Applications by the Applicants whose PAN is not available as per the Demographic Details available in their Depository records, are liable to be rejected.
- c) The exemption for the PAN Exempted Applicants is subject to (a) the Demographic Details received from the respective Depositories confirming the exemption granted to the beneficiary owner by a suitable description in the PAN field and the beneficiary account remaining in “active status”; and (b) in the case of residents of Sikkim, the address as per the Demographic Details evidencing the same.
- d) Bid cum Application Forms which provide the General Index Register Number instead of PAN may be rejected.
- e) Bids/Applications by Applicant whose demat accounts have been ‘suspended for credit’ are liable to be rejected pursuant to the circular issued by SEBI on July 29, 2010, bearing number CIR/MRD/DP/22/2010. Such accounts are classified as “Inactive demat accounts” and Demographic Details are not provided by depositories.

4.1.3 FIELD NUMBER 3: APPLICANTS DEPOSITORY ACCOUNT DETAILS

- a) Applicants should ensure that DP ID and the Client ID are correctly filled in the Bid cum Application Form/Application Form. The DP ID and Client ID provided in the Bid cum Application Form/Application Form should match with the DP ID and Client ID available in the Depository database, **otherwise, the Bid cum Application Form/Application Form is liable to be rejected.**
- b) Applicants should ensure that the beneficiary account provided in the Bid cum Application Form/Application Form is active.
- c) Applicants should note that on the basis of the DP ID and Client ID as provided in the Bid cum Application Form/Application Form, the Applicant may be deemed to have authorized the Depositories to provide to the Registrar to the Issue, any requested Demographic Details of the Applicant as available on the records of the depositories. These Demographic Details may be used, among other things, for unblocking of ASBA Account or for other correspondence(s) related to an Issue.
- d) Applicants are, advised to update any changes to their Demographic Details as available in the records of the Depository Participant to ensure accuracy of records. Any delay resulting from failure to update the Demographic Details would be at the Applicants’ sole risk.

4.1.4 FIELD NUMBER 4: BID OPTIONS

- a) Price or Floor Price or Price Band, minimum Bid Lot and Discount (if applicable) may be disclosed in the Prospectus by the Issuer. The Issuer is required to announce the Floor Price or Price Band, minimum Bid Lot and Discount (if applicable) by way of an advertisement in at least one English, one Hindi and one regional newspaper, with wide circulation, at least five Working Days before Bid/ Issue Opening Date in case of an IPO, and at least one Working Day before Bid/ Issue Opening Date in case of an FPO.
- b) The Bidders may Bid at or above Floor Price or within the Price Band for IPOs/FPOs undertaken through the Book Building Process. In the case of Alternate Book Building Process for an FPO, the Bidders may Bid at Floor Price or any price above the Floor Price (For further details Bidders may refer to (Section 5.6 (e))
- c) **Cut-Off Price:** Retail Individual Investors or Employees or Retail Individual Shareholders can Bid at the Cut-off Price indicating their agreement to Bid for and purchase the Equity Shares at the Issue Price as determined



at the end of the Book Building Process. Bidding at the Cut-off Price is prohibited for QIBs and NIIs and such Bids from QIBs and NIIs may be rejected.

- d) **Minimum Application Value and Bid Lot:** The Issuer in consultation with the BRLMs may decide the minimum number of Equity Shares for each Bid to ensure that the minimum application value is within the range of ₹ 1,00,000 to ₹ 2,00,000. The minimum Bid Lot is accordingly determined by an Issuer on basis of such minimum application value.
- e) **Allotment:** The Allotment of specified securities to each RII shall not be less than the minimum Bid Lot, subject to availability of shares in the RII category, and the remaining available shares, if any, shall be Allotted on a proportionate basis. For details of the Bid Lot, Applicants may refer to the Prospectus or the advertisement regarding the Price Band published by the Issuer.

4.1.4.1 MAXIMUM AND MINIMUM BID SIZE

- a) The Bidder may Bid for the desired number of Equity Shares at a specific price. Bids by Retail Individual Investors, Employees and Retail Individual Shareholders must be for such number of shares so as to ensure that the Bid Amount less Discount (as applicable), payable by the Bidder does not exceed ₹ 2,00,000.
- b) In case the Bid Amount exceeds ₹ 2,00,000 due to revision of the Bid or any other reason, the Bid may be considered for allocation under the Non-Institutional Category (with it not being eligible for Discount), then such Bid may be rejected if it is at the Cut-off Price.
- c) For NRIs, a Bid Amount of up to ₹ 2,00,000 may be considered under the Retail Category for the purposes of allocation and a Bid Amount exceeding ₹ 2,00,000 may be considered under the Non-Institutional Category for the purposes of allocation.
- d) Bids by QIBs and NIIs must be for such minimum number of shares such that the Bid Amount exceeds ₹ 2,00,000 and in multiples of such number of Equity Shares thereafter, as may be disclosed in the Bid cum Application Form and the Prospectus, or as advertised by the Issuer, as the case may be. Non-Institutional Investors and QIBs are not allowed to Bid at Cut off Price.
- e) RII may revise or withdraw their bids until Bid/ Issue Closing Date. QIBs and NII's cannot withdraw or lower their Bids (in terms of quantity of Equity Shares or the Bid Amount) at any stage after Bidding and are required to pay the Bid Amount upon submission of the Bid.
- f) In case the Bid Amount reduces to ₹ 2,00,000 or less due to a revision of the Price Band, Bids by the Non-Institutional Investors who are eligible for allocation in the Retail Category would be considered for allocation under the Retail Category.
- g) For Anchor Investors, if applicable, the Bid Amount shall be least ₹ 10 crores. One-third of the Anchor Investor Portion shall be reserved for domestic Mutual Funds, subject to valid Bids being received from domestic Mutual Funds at or above the price at which allocation is being done to other Anchor Investors. Bids by various schemes of a Mutual Fund shall be aggregated to determine the Bid Amount. A Bid cannot be submitted for more than 60% of the QIB Category under the Anchor Investor Portion. Anchor Investors cannot withdraw their Bids or lower the size of their Bids (in terms of quantity of Equity Shares or the Bid Amount) at any stage after the Anchor Investor Bid/ Issue Period and are required to pay the Bid Amount at the time of submission of the Bid. In case the Anchor Investor Issue Price is lower than the Issue Price, the balance amount shall be payable as per the pay-in-date mentioned in the revised CAN. In case the Issue Price is lower than the Anchor Investor Issue Price, the amount in excess of the Issue Price paid by the Anchor Investors shall not be refunded to them.
- h) A Bid cannot be submitted for more than the Issue size.



- i) The maximum Bid by any Applicant including QIB Applicant should not exceed the investment limits prescribed for them under the applicable laws.
- j) The price and quantity options submitted by the Bidder in the Bid cum Application Form may be treated as optional bids from the Bidder and may not be cumulated. After determination of the Issue Price, the number of Equity Shares Bid for by a Bidder at or above the Issue Price may be considered for Allotment and the rest of the Bid(s), irrespective of the Bid Amount may automatically become invalid. This is not applicable in case of FPOs undertaken through Alternate Book Building Process (For details of Bidders may refer to (Section 5.6 (e)))

4.1.4.2 MULTIPLE BIDS

- a) Bidder should submit only one Bid cum Application Form. Bidder shall have the option to make a maximum of three Bids at different price levels in the Bid cum Application Form and such options are not considered as multiple Bids.

Submission of a second Bid cum Application Form to either the same or to another Designated Intermediary and duplicate copies of Bid cum Application Forms bearing the same application number shall be treated as multiple Bids and are liable to be rejected.

- b) Bidders are requested to note the following procedures may be followed by the Registrar to the Issue to detect multiple Bids:
 - 1) All Bids may be checked for common PAN as per the records of the Depository. For Bidders other than Mutual Funds and FII sub-accounts, Bids bearing the same PAN may be treated as multiple Bids by a Bidder and may be rejected.
 - 2) For Bids from Mutual Funds and FII sub-accounts, submitted under the same PAN, as well as Bids on behalf of the PAN Exempted Bidders, the Bid cum Application Forms may be checked for common DP ID and Client ID. Such Bids which have the same DP ID and Client ID may be treated as multiple Bids and are liable to be rejected.
- c) The following Bids may not be treated as multiple Bids:
 - 1) Bids by Reserved Categories Bidding in their respective Reservation Portion as well as bids made by them in the Issue portion in public category.
 - 2) Separate Bids by Mutual Funds in respect of more than one scheme of the Mutual Fund provided that the Bids clearly indicate the scheme for which the Bid has been made.
 - 3) Bids by Mutual Funds, and sub-accounts of FIIs (or FIIs and its sub-accounts) submitted with the same PAN but with different beneficiary account numbers, Client IDs and DP IDs.
 - 4) Bids by Anchor Investors under the Anchor Investor Portion and the QIB Category.

4.1.5 FIELD NUMBER 5: CATEGORY OF BIDDERS

- a) The categories of Bidders identified as per the SEBI ICDR Regulations, 2009 for the purpose of Bidding, allocation and Allotment in the Issue are RIIs, NIIs and QIBs.
- b) Up to 60% of the QIB Category can be allocated by the Issuer, on a discretionary basis subject to the criteria of minimum and maximum number of Anchor Investors based on allocation size, to the Anchor Investors, in accordance with SEBI ICDR Regulations, 2009, with one-third of the Anchor Investor Portion reserved for domestic Mutual Funds subject to valid Bids being received at or above the Issue Price. For details regarding allocation to Anchor Investors, Bidders may refer to the Prospectus.



- c) An Issuer can make reservation for certain categories of Bidders/Applicants as permitted under the SEBI ICDR Regulations, 2009. For details of any reservations made in the Issue, Bidders/Applicants may refer to the Prospectus.
- d) The SEBI ICDR Regulations, 2009, specify the allocation or Allotment that may be made to various categories of Bidders in an Issue depending upon compliance with the eligibility conditions. Details pertaining to allocation are disclosed on reverse side of the Revision Form. For Issue specific details in relation to allocation Bidder/Applicant may refer to the Prospectus.

4.1.6 FIELD NUMBER 6: INVESTOR STATUS

- a) Each Applicant should check whether it is eligible to apply under applicable law and ensure that any prospective Allotment to it in the Issue is in compliance with the investment restrictions under applicable law.
- b) Certain categories of Applicants, such as NRIs, FPIs and FVCIs may not be allowed to Bid/Apply in the Issue or hold Equity Shares exceeding certain limits specified under applicable law. Applicants are requested to refer to the Prospectus for more details.
- c) Applicants should check whether they are eligible to apply on non -repatriation basis or repatriation basis and should accordingly provide the investor status. Details regarding investor status are different in the Resident Bid cum Application Form and Non-Resident Bid cum Application Form.
- d) Applicants should ensure that their investor status is updated in the Depository records.

4.1.7 FIELD NUMBER 7: PAYMENT DETAILS

- a) The full Bid Amount (net of any Discount, as applicable) shall be blocked based on the authorisation provided in the Bid cum Application Form. If the Discount is applicable in the Issue, the RIIs should indicate the full Bid Amount in the Bid cum Application Form and the funds shall be blocked for Bid Amount net of Discount. Only in cases where the Prospectus indicates that part payment may be made, such an option can be exercised by the Bidder. In case of Bidders specifying more than one Bid Option in the Bid cum Application Form, the total Bid Amount may be calculated for the highest of three options at net price, i.e. Bid price less Discount offered, if any.
- b) Bidders who Bid at Cut-off Price shall deposit the Bid Amount based on the Cap Price.
- c) All Bidders (except Anchor Investors) can participate in the Issue only through the ASBA mechanism.
- d) Bid Amount cannot be paid in cash, through money order or through postal order.

4.1.7.1 Instructions for Anchor Investors:

- a) Anchor Investors may submit their Bids with a Book Running Lead Manager.
- b) Payments should be made either by RTGS, NEFT or cheque/ demand draft drawn on any bank (including a co-operative bank), which is situated at, and is a member of or sub-member of the bankers' clearing house located at the centre where the Anchor Investor Application Form is submitted. Cheques/bank drafts drawn on banks not participating in the clearing process may not be accepted and applications accompanied by such cheques or bank drafts are liable to be rejected.
- c) If the cheque or demand draft accompanying the Bid cum Application Form is not made favouring the Escrow Account, the Bid is liable to be rejected.



- d) The Escrow Collection Banks shall maintain the monies in the Escrow Account for and on behalf of the Anchor Investors until the Designated Date.
- e) Anchor Investors are advised to provide the number of the Anchor Investor Application Form and PAN on the reverse of the cheque or bank draft to avoid any possible misuse of instruments submitted.

4.1.7.2 Payment instructions for Bidders (other than Anchor Investors)

- a) Bidders may submit the Bid cum Application Form either
 - 1) in physical mode to the Designated Branch of an SCSB where the Applicants have ASBA Account, or
 - 2) in electronic mode through the internet banking facility offered by an SCSB authorizing blocking of funds that are available in the ASBA account specified in the Bid cum Application Form, or
 - 3) in physical mode to any Designated Intermediary.
- b) Bidders must specify the Bank Account number in the Bid cum Application Form. The Bid cum Application Form submitted by Bidder and which is accompanied by cash, demand draft, money order, postal order or any mode of payment other than blocked amounts in the ASBA Account maintained with an SCSB, may not be accepted.
- c) Bidders should ensure that the Bid cum Application Form is also signed by the ASBA Account holder(s) if the Bidder is not the ASBA Account holder;
- d) Bidders shall note that for the purpose of blocking funds under ASBA facility clearly demarcated funds shall be available in the account.
- e) From one ASBA Account, a maximum of five Bids cum Application Forms can be submitted.
- f) Bidders bidding through a member of the Syndicate should ensure that the Bid cum Application Form is submitted to a member of the Syndicate only at the Specified Locations. Bidders should also note that Bid cum Application Forms submitted to the Syndicate at the Specified Locations may not be accepted by the member of the Syndicate if the SCSB where the ASBA Account, as specified in the Bid cum Application Form, is maintained has not named at least one branch at that location for the members of the Syndicate to deposit Bid cum Application Forms (a list of such branches is available on the website of SEBI at <http://www.sebi.gov.in/sebiweb/home/list/5/33/0/0/Recognised-Intermediaries>).
- g) Bidders bidding through a Registered Broker, RTA or CDP should note that Bid cum Application Forms submitted to them may not be accepted, if the SCSB where the ASBA Account, as specified in the Bid cum Application Form, is maintained has not named at least one branch at that location for the Registered Brokers, RTA or CDP, as the case may be, to deposit Bid cum Application Forms.
- h) Bidders bidding directly through the SCSBs should ensure that the Bid cum Application Form is submitted to a Designated Branch of a SCSB where the ASBA Account is maintained.
- i) Upon receipt of the Bid cum Application Form, the Designated Branch of the SCSB may verify if sufficient funds equal to the Bid Amount are available in the ASBA Account, as mentioned in the Bid cum Application Form.
- j) If sufficient funds are available in the ASBA Account, the SCSB may block an amount equivalent to the Bid Amount mentioned in the Bid cum Application Form and for application directly submitted to SCSB by investor, may enter each Bid option into the electronic bidding system as a separate Bid.



- k) If sufficient funds are not available in the ASBA Account, the Designated Branch of the SCSB may not upload such Bids on the Stock Exchange platform and such bids are liable to be rejected.
- l) Upon submission of a completed Bid cum Application Form each Bidder may be deemed to have agreed to block the entire Bid Amount and authorized the Designated Branch of the SCSB to block the Bid Amount specified in the Bid cum Application Form in the ASBA Account maintained with the SCSBs.
- m) The Bid Amount may remain blocked in the aforesaid ASBA Account until finalisation of the Basis of Allotment and consequent transfer of the Bid Amount against the Allotted Equity Shares to the Public Issue Account, or until withdrawal or failure of the Issue, or until withdrawal or rejection of the Bid, as the case may be.
- n) SCSBs bidding in the Issue must apply through an Account maintained with any other SCSB; else their Bids are liable to be rejected.

4.1.7.2.1 Unblocking of ASBA Account

- a) Once the Basis of Allotment is approved by the Designated Stock Exchange, the Registrar to the Issue may provide the following details to the controlling branches of each SCSB, along with instructions to unblock the relevant bank accounts and for successful applications transfer the requisite money to the Public Issue Account designated for this purpose, within the specified timelines: (i) the number of Equity Shares to be Allotted against each Bid, (ii) the amount to be transferred from the relevant bank account to the Public Issue Account, for each Bid, (iii) the date by which funds referred to in (ii) above may be transferred to the Public Issue Account, and (iv) details of rejected Bids, if any, along with reasons for rejection and details of withdrawn or unsuccessful Bids, if any, to enable the SCSBs to unblock the respective bank accounts.
- b) On the basis of instructions from the Registrar to the Issue, the SCSBs may transfer the requisite amount against each successful Bidder to the Public Issue Account and may unblock the excess amount, if any, in the ASBA Account.
- c) In the event of withdrawal or rejection of the Bid cum Application Form and for unsuccessful Bids, the Registrar to the Issue may give instructions to the SCSB to unblock the Bid Amount in the relevant ASBA Account within six Working Days of the Bid/ Issue Closing Date.

4.1.7.3 Discount (if applicable)

- a) The Discount is stated in absolute rupee terms.
- b) Bidders applying under RII category, Retail Individual Shareholder and employees are only eligible for discount. For Discounts offered in the Issue, Bidders may refer to the Prospectus.
- c) The Bidders entitled to the applicable Discount in the Issue may block an amount i.e. the Bid Amount less Discount (if applicable).

Bidder may note that in case the net amount blocked (post Discount) is more than two lakh Rupees, the Bidding system automatically considers such applications for allocation under Non-Institutional Category. These applications are neither eligible for Discount nor fall under RII category.

4.1.8 FIELD NUMBER 8: SIGNATURES AND OTHER AUTHORISATIONS

- a) Only the First Applicant is required to sign the Bid cum Application Form/Application Form. Applicants should ensure that signatures are in one of the languages specified in the Eighth Schedule to the Constitution of India.



- b) If the ASBA Account is held by a person or persons other than the Applicant, then the Signature of the ASBA Account holder(s) is also required.
- c) The signature has to be correctly affixed in the authorisation/undertaking box in the Bid cum Application Form/Application Form, or an authorisation has to be provided to the SCSB via the electronic mode, for blocking funds in the ASBA Account equivalent to the Bid Amount mentioned in the Bid cum Application Form/Application Form.
- d) Applicants must note that Bid cum Application Form/Application Form without signature of Applicant and/or ASBA Account holder is liable to be rejected.

4.1.9 ACKNOWLEDGEMENT AND FUTURE COMMUNICATION

- a) Bidders should ensure that they receive the Acknowledgement Slip duly signed and stamped by the Designated Intermediary, as applicable, for submission of the Bid cum Application Form.
- b) All communications in connection with Bids/Applications made in the Issue should be addressed as under:
 - 1) In case of queries related to Allotment, non-receipt of Allotment Advice, credit of Allotted Equity Shares, refund orders, the Applicants should contact the Registrar to the Issue.
 - 2) In case of Bids submitted to the Designated Branches of the SCSBs, the Applicants should contact the relevant Designated Branch of the SCSB.
 - 3) In case of queries relating to uploading of Bids by a Syndicate Member, the Applicants should contact the relevant Syndicate Member.
 - 4) In case of queries relating to uploading of Bids by a Registered Broker, the Applicants should contact the relevant Registered Broker
 - 5) In case of Bids submitted to the RTA, the Applicants should contact the relevant RTA.
 - 6) In case of Bids submitted to the DP, the Applicants should contact the relevant DP.
 - 7) Applicant may contact our Company Secretary and Compliance Officer or BRLM(s) in case of any other complaints in relation to the Issue.
- c) The following details (as applicable) should be quoted while making any queries –
 - 1) full name of the sole or First Applicant, Bid cum Application Form number, Applicants' DP ID, Client ID, PAN, number of Equity Shares applied for, amount paid on application;
 - 2) name and address of the Designated Intermediary, where the Bid was submitted; or
 - 3) In case of Bids other than from Anchor Investors, ASBA Account number in which the amount equivalent to the Bid Amount was blocked.
- d) In case of Anchor Investor bids cheque or draft number and the name of the issuing bank thereof.

For further details, Applicant may refer to the Prospectus and the Bid cum Application Form.



4.2 INSTRUCTIONS FOR FILING THE REVISION FORM

- a) During the Bid/ Issue Period, any Applicant (other than QIBs and NIIs, who can only revise their bid upwards) who has registered his or her interest in the Equity Shares at a particular price level is free to revise his or her Bid within the Price Band using the Revision Form, which is a part of the Bid cum Application Form.
- b) RII may revise their bids or withdraw their Bids till the Bid/ Issue Close Date.
- c) Revisions can be made in both the desired number of Equity Shares and the Bid Amount by using the Revision Form.
- d) The Applicant can make this revision any number of times during the Bid/ Issue Period. However, for any revision(s) in the Bid, the /Applicants will have to use the services of the same Designated Intermediary through which such Applicant had placed the original Bid. Applicants are advised to retain copies of the blank Revision Form and the Bid(s) must be made only in such Revision Form or copies thereof.



A sample revision form is reproduced below:

COMMON BID REVISION FORM	XYZ LIMITED - INITIAL PUBLIC ISSUE - R Address : Contact Details: CIN No	FOR RESIDENT INDIANS, INCLUDING RESIDENT QIBs, AND ELIGIBLE NRIs APPLYING ON A NON-REPATRIATION BASIS																								
LOGO	TO, THE BOARD OF DIRECTORS XYZ LIMITED	<table border="1" style="width:100%; border-collapse: collapse;"> <tr> <td style="width:50%; text-align:center;">BOOK BUILT ISSUE</td> <td style="width:50%; text-align:center;">Bid cum Application Form No. _____</td> </tr> <tr> <td style="text-align:center;">ISIN :</td> <td></td> </tr> </table>	BOOK BUILT ISSUE	Bid cum Application Form No. _____	ISIN :																					
BOOK BUILT ISSUE	Bid cum Application Form No. _____																									
ISIN :																										
SYNDICATE MEMBER'S STAMP & CODE	BROKER/SCSB/DP/RTA STAMP & CODE	1. NAME & CONTACT DETAILS OF SOLE / FIRST BIDDER																								
		Mr./Ms. _____ Address _____ Tel. No (with STD code) / Mobile _____ Email _____																								
SUB-BROKER'S / SUB-AGENT'S STAMP & CODE	ESCROW BANK/SCSB BRANCH STAMP & CODE	2. PAN OF SOLE / FIRST BIDDER																								
		3. BIDDER'S DEPOSITORY ACCOUNT DETAILS																								
BANK BRANCH SERIAL NO.	SCSB SERIAL NO.	<input type="checkbox"/> NSDL <input type="checkbox"/> CDSL <small>For NSDL enter 8 digit DP ID followed by 8 digit Client ID / For CDSL enter 16 digit Client ID</small>																								
PLEASE CHANGE MY BID																										
4. FROM (AS PER LAST BID OR REVISION)																										
Bid Options:	No. of Equity Shares Bid (Bids must be in multiples of Bid Lot as advertised)	Price per Equity Share (₹) "Cut-off" (Price in multiples of ₹ 1/- only)																								
	(In Figures)	(In Figures)																								
	8 7 6 5 4 3 2 1	Bid Price Retail Discount Net Price "Cut-off" (Please ✓ tick)																								
Option 1	_____	_____																								
(OR) Option 2	_____	_____																								
(OR) Option 3	_____	_____																								
5. TO (Revised Bid) (Only Retail Individual Bidders can Bid at "Cut-off")																										
Bid Options:	No. of Equity Shares Bid (Bids must be in multiples of Bid Lot as advertised)	Price per Equity Share (₹) "Cut-off" (Price in multiples of ₹ 1/- only)																								
	(In Figures)	(In Figures)																								
	8 7 6 5 4 3 2 1	Bid Price Retail Discount Net Price "Cut-off" (Please ✓ tick)																								
Option 1	_____	_____																								
(OR) Option 2	_____	_____																								
(OR) Option 3	_____	_____																								
6. PAYMENT DETAILS																										
Additional Amount Paid (₹ in figures) _____ (₹ in words) _____		PAYMENT OPTION : FULL PAYMENT <input type="checkbox"/> PART PAYMENT <input type="checkbox"/>																								
ASBA Bank A/c No. _____																										
Bank Name & Branch _____																										
<small>I/WE (ON BEHALF OF JOINT APPLICANTS, IF ANY) HEREBY CONFIRM THAT I/WE HAVE READ AND UNDERSTOOD THE TERMS AND CONDITIONS OF THIS BID REVISION FORM AND THE ATTACHED ABBRIDGED PROSPECTUS AND THE GENERAL INFORMATION DOCUMENT FOR INVESTING IN PUBLIC ISSUES ("CID") AND HEREBY AGREE AND CONFIRM THE "BIDDERS UNDERTAKING" AS GIVEN OVERLEAF. I/WE (ON BEHALF OF JOINT APPLICANTS, IF ANY) HEREBY CONFIRM THAT I/WE HAVE READ THE INSTRUCTIONS FOR FILLING UP THE BID REVISION FORM GIVEN OVERLEAF.</small>																										
7A. SIGNATURE OF SOLE / FIRST BIDDER	7B. SIGNATURE OF ASBA BANK ACCOUNT HOLDER(s) (AS PER BANK RECORDS)	BROKER / SCSB / DP / RTA STAMP (Acknowledging upload of Bid in Stock Exchange system)																								
	I/We authorize the SCSB to do all acts as are necessary to make the Application in the line 1) _____ 2) _____ 3) _____	_____																								
TEAR HERE																										
LOGO	XYZ LIMITED BID REVISION FORM - INITIAL PUBLIC ISSUE - R	<table border="1" style="width:100%; border-collapse: collapse;"> <tr> <td style="width:50%; text-align:center;">Acknowledgement Slip for Broker/SCSB/DP/RTA</td> <td style="width:50%; text-align:center;">Bid cum Application Form No. _____</td> </tr> <tr> <td colspan="2" style="text-align:center;">PAN of Sole / First Bidder _____</td> </tr> </table>	Acknowledgement Slip for Broker/SCSB/DP/RTA	Bid cum Application Form No. _____	PAN of Sole / First Bidder _____																					
Acknowledgement Slip for Broker/SCSB/DP/RTA	Bid cum Application Form No. _____																									
PAN of Sole / First Bidder _____																										
DPID / CLID	Additional Amount Paid (₹) _____ Bank & Branch _____	Stamp & Signature of SCSB Branch																								
ASBA Bank A/c No. _____	Received from Mr./Ms. _____	_____																								
Telephone / Mobile _____	Email _____	_____																								
TEAR HERE																										
XYZ LIMITED - BID REVISION FORM - INITIAL PUBLIC ISSUE - R	<table border="1" style="width:100%; border-collapse: collapse;"> <tr> <td style="width:33%;">Option 1</td> <td style="width:33%;">Option 2</td> <td style="width:33%;">Option 3</td> </tr> <tr> <td style="text-align:center;">No. of Equity Shares</td> <td style="text-align:center;">_____</td> <td style="text-align:center;">_____</td> </tr> <tr> <td style="text-align:center;">Bid Price</td> <td style="text-align:center;">_____</td> <td style="text-align:center;">_____</td> </tr> <tr> <td colspan="3" style="text-align:center;">Additional Amount Paid (₹) _____</td> </tr> <tr> <td colspan="3" style="text-align:center;">ASBA Bank A/c No. _____</td> </tr> <tr> <td colspan="3" style="text-align:center;">Bank & Branch _____</td> </tr> </table>	Option 1	Option 2	Option 3	No. of Equity Shares	_____	_____	Bid Price	_____	_____	Additional Amount Paid (₹) _____			ASBA Bank A/c No. _____			Bank & Branch _____			<table border="1" style="width:100%; border-collapse: collapse;"> <tr> <td style="width:50%; text-align:center;">Stamp & Signature of Broker / SCSB / DP / RTA</td> <td style="width:50%; text-align:center;">Name of Sole / First Bidder _____</td> </tr> <tr> <td colspan="2" style="text-align:center;">Acknowledgement Slip for Bidder</td> </tr> <tr> <td colspan="2" style="text-align:center;">Bid cum Application Form No. _____</td> </tr> </table>	Stamp & Signature of Broker / SCSB / DP / RTA	Name of Sole / First Bidder _____	Acknowledgement Slip for Bidder		Bid cum Application Form No. _____	
Option 1	Option 2	Option 3																								
No. of Equity Shares	_____	_____																								
Bid Price	_____	_____																								
Additional Amount Paid (₹) _____																										
ASBA Bank A/c No. _____																										
Bank & Branch _____																										
Stamp & Signature of Broker / SCSB / DP / RTA	Name of Sole / First Bidder _____																									
Acknowledgement Slip for Bidder																										
Bid cum Application Form No. _____																										

TEAR HERE



Instructions to fill each field of the Revision Form can be found on the reverse side of the Revision Form. Other than instructions already highlighted at paragraph 4.1 above, point wise instructions regarding filling up various fields of the Revision Form are provided below:

4.2.1 FIELDS 1, 2 AND 3: NAME AND CONTACT DETAILS OF SOLE/FIRST APPLICANT, PAN OF SOLE/FIRST APPLICANT & DEPOSITORY ACCOUNT DETAILS OF THE APPLICANT

Applicants should refer to instructions contained in paragraphs 4.1.1, 4.1.2 and 4.1.3. 4.2.2

FIELD 4 & 5: BID OPTIONS REVISION 'FROM' AND 'TO'

- a) Apart from mentioning the revised options in the Revision Form, the Applicant must also mention the details of all the bid options given in his or her Bid cum Application Form or earlier Revision Form. For example, if a Applicant has Bid for three options in the Bid cum Application Form and such Applicant is changing only one of the options in the Revision Form, the Applicant must still fill the details of the other two options that are not being revised, in the Revision Form. The members of the Syndicate, the Registered Brokers and the Designated Branches of the SCSBs may not accept incomplete or inaccurate Revision Forms.
- b) In case of revision, Bid options should be provided by Applicants in the same order as provided in the Bid cum Application Form.
- c) In case of revision of Bids by RIIs, Employees and Retail Individual Shareholders, such Applicants should ensure that the Bid Amount, subsequent to revision, does not exceed ₹ 200,000. In case the Bid Amount exceeds ₹ 200,000 due to revision of the Bid or for any other reason, the Bid may be considered, subject to eligibility, for allocation under the Non-Institutional Category, not being eligible for Discount (if applicable) and such Bid may be rejected if it is at the Cut-off Price. The Cut-off Price option is given only to the RIIs, Employees and Retail Individual Shareholders indicating their agreement to Bid for and purchase the Equity Shares at the Issue Price as determined at the end of the Book Building Process.
- d) In case the total amount (i.e., original Bid Amount plus additional payment) exceeds ₹ 200,000, the Bid will be considered for allocation under the Non-Institutional Category in terms of the Prospectus. If, however, the RII does not either revise the Bid or make additional payment and the Issue Price is higher than the cap of the Price Band prior to revision, the number of Equity Shares Bid for shall be adjusted downwards for the purpose of allocation, such that no additional payment would be required from the RII and the RII is deemed to have approved such revised Bid at Cut-off Price.
- e) In case of a downward revision in the Price Band, RIIs and Bids by Employees under the Reservation Portion, who have bid at the Cut-off Price could either revise their Bid or the excess amount paid at the time of Bidding may be unblocked in case of Bidders.

4.2.3 FIELD 6: PAYMENT DETAILS

- a) All Applicants are required to make payment of the full Bid Amount (less Discount, if applicable) along with the Bid Revision Form. In case of Applicants specifying more than one Bid Option in the Bid cum Application Form, the total Bid Amount may be calculated for the highest of three options at net price, i.e. Bid price less discount offered, if any.
- b) Applicant may Issue instructions to block the revised amount based on cap of the revised Price Band (adjusted for the Discount (if applicable) in the ASBA Account, to the same Designated Intermediary through whom such Applicant had placed the original Bid to enable the relevant SCSB to block the additional Bid Amount, if any



- c) In case the total amount (i.e., original Bid Amount less discount (if applicable) plus additional payment) exceeds ₹ 200,000, the Bid may be considered for allocation under the Non-Institutional Category in terms of the Prospectus. If, however, the Applicant does not either revise the Bid or make additional payment and the Issue Price is higher than the cap of the Price Band prior to revision, the number of Equity Shares Bid for may be adjusted downwards for the purpose of Allotment, such that additional amount is required blocked and the Applicant is deemed to have approved such revised Bid at the Cut-off Price.
- d) In case of a downward revision in the Price Band, RIIs, Employees and Retail Individual Shareholders, who have bid at the Cut-off Price, could either revise their Bid or the excess amount paid at the time of Bidding may be unblocked.

4.2.4 FIELDS 7 : SIGNATURES AND ACKNOWLEDGEMENTS

Applicants may refer to instructions contained at paragraphs 4.1.8 and 4.1.9 for this purpose.

4.3 INSTRUCTIONS FOR FILING APPLICATION FORM IN ISSUES MADE OTHER THAN THROUGH THE BOOK BUILDING PROCESS (FIXED PRICE ISSUE)

4.3.1 FIELDS 1, 2, 3 NAME AND CONTACT DETAILS OF SOLE/FIRST APPLICANT, PAN OF SOLE/FIRST APPLICANT & DEPOSITORY ACCOUNT DETAILS OF THE APPLICANT

Applicants should refer to instructions contained in paragraphs 4.1.1, 4.1.2 and 4.1.3.

4.3.2 FIELD 4: PRICE, APPLICATION QUANTITY & AMOUNT

- a) The Issuer may mention Price or Price Band in the Prospectus. However a prospectus registered with RoC contains one price or coupon rate (as applicable).
- b) **Minimum Application Value and Bid Lot:** The Issuer in consultation with the Lead Manager to the Issue (LM) may decide the minimum number of Equity Shares for each Bid to ensure that the minimum application value is within the range of ₹ 1,00,000 to ₹ 2,00,000. The minimum Lot size is accordingly determined by an Issuer on basis of such minimum application value.
- c) Applications by RIIs, Employees and Retail Individual Shareholders, must be for such number of shares so as to ensure that the application amount payable does not exceed ₹ 200,000.
- d) Applications by other investors must be for such minimum number of shares such that the application amount exceeds ₹ 200,000 and in multiples of such number of Equity Shares thereafter, as may be disclosed in the application form and the Prospectus, or as advertised by the Issuer, as the case may be.
- e) An application cannot be submitted for more than the Issue size.
- f) The maximum application by any Applicant should not exceed the investment limits prescribed for them under the applicable laws.
- g) **Multiple Applications:** An Applicant should submit only one Application Form. Submission of a second Application Form to either the same or other SCSB and duplicate copies of Application Forms bearing the same application number shall be treated as multiple applications and are liable to be rejected.
- h) Applicants are requested to note the following procedures may be followed by the Registrar to the Issue to detect multiple applications:



- 1) All applications may be checked for common PAN as per the records of the Depository. For Applicants other than Mutual Funds and FII sub-accounts, Bids bearing the same PAN may be treated as multiple applications by a Applicant and may be rejected.
 - 2) For applications from Mutual Funds and FII sub-accounts, submitted under the same PAN, as well as Bids on behalf of the PAN Exempted Applicants, the Application Forms may be checked for common DP ID and Client ID. In any such applications which have the same DP ID and Client ID, these may be treated as multiple applications and may be rejected.
- i) The following applications may not be treated as multiple Bids:
- 1) Applications by Reserved Categories in their respective reservation portion as well as that made by them in the Issue portion in public category.
 - 2) Separate applications by Mutual Funds in respect of more than one scheme of the Mutual Fund provided that the Applications clearly indicate the scheme for which the Bid has been made.
 - 3) Applications by Mutual Funds, and sub-accounts of FIIs (or FIIs and its subaccounts) submitted with the same PAN but with different beneficiary account numbers, Client IDs and DP IDs.

4.3.3 FIELD NUMBER 5 : CATEGORY OF APPLICANTS

- a) The categories of applicants identified as per the SEBI ICDR Regulations, 2009 for the purpose of Bidding, allocation and Allotment in the Issue are RIIs, individual applicants other than RII's and other investors (including corporate bodies or institutions, irrespective of the number of specified securities applied for).
- b) An Issuer can make reservation for certain categories of Applicants permitted under the SEBI ICDR Regulations, 2009. For details of any reservations made in the Issue, applicants may refer to the Prospectus.
- c) The SEBI ICDR Regulations, 2009 specify the allocation or Allotment that may be made to various categories of applicants in an Issue depending upon compliance with the eligibility conditions. Details pertaining to allocation are disclosed on reverse side of the Revision Form. For Issue specific details in relation to allocation applicant may refer to the Prospectus.

4.3.4 FIELD NUMBER 6: INVESTOR STATUS

Applicants should refer to instructions contained in paragraphs 4.1.6.

4.3.5 FIELD 7: PAYMENT DETAILS

- a) All Applicants (other than Anchor Investors) are required to make use ASBA for applying in the Issue
- b) Application Amount cannot be paid in cash, through money order, cheque or through postal order or through stock invest.

4.3.5.1 Payment instructions for Applicants

- a) Applicants may submit the Application Form in physical mode to the Designated Intermediaries.
- b) Applicants must specify the Bank Account number in the Application Form. The Application Form submitted by an Applicant and which is accompanied by cash, demand draft, money order, postal order or any mode of payment other than blocked amounts in the ASBA Account maintained with an SCSB, will not be accepted.



- c) Applicants should ensure that the Application Form is also signed by the ASBA Account holder(s) if the Applicant is not the ASBA Account holder;
- d) Applicants shall note that for the purpose of blocking funds under ASBA facility clearly demarcated funds shall be available in the account.
- e) From one ASBA Account, a maximum of five Bids cum Application Forms can be submitted.
- f) Applicants bidding directly through the SCSBs should ensure that the Application Form is submitted to a Designated Branch of a SCSB where the ASBA Account is maintained.
- g) Upon receipt of the Application Form, the Designated Branch of the SCSB may verify if sufficient funds equal to the Application Amount are available in the ASBA Account, as mentioned in the Application Form.
- h) If sufficient funds are available in the ASBA Account, the SCSB may block an amount equivalent to the Application Amount mentioned in the Application Form and may upload the details on the Stock Exchange Platform.
- i) If sufficient funds are not available in the ASBA Account, the Designated Branch of the SCSB may not upload such Applications on the Stock Exchange platform and such Applications are liable to be rejected.
- j) Upon submission of a completed Application Form each Applicant may be deemed to have agreed to block the entire Application Amount and authorized the Designated Branch of the SCSB to block the Application Amount specified in the Application Form in the ASBA Account maintained with the SCSBs.
- k) The Application Amount may remain blocked in the aforesaid ASBA Account until finalisation of the Basis of Allotment and consequent transfer of the Application Amount against the Allotted Equity Shares to the Public Issue Account, or until withdrawal or failure of the Issue, or until withdrawal or rejection of the Application, as the case may be.
- l) SCSBs applying in the Issue must apply through an ASBA Account maintained with any other SCSB; else their Applications are liable to be rejected.

4.3.5.2 Unblocking of ASBA Account

- a) Once the Basis of Allotment is approved by the Designated Stock Exchange, the Registrar to the Issue may provide the following details to the controlling branches of each SCSB, along with instructions to unblock the relevant bank accounts and for successful applications transfer the requisite money to the Public Issue Account designated for this purpose, within the specified timelines: (i) the number of Equity Shares to be Allotted against each Application, (ii) the amount to be transferred from the relevant bank account to the Public Issue Account, for each Application, (iii) the date by which funds referred to in (ii) above may be transferred to the Public Issue Account, and (iv) details of rejected Applications, if any, along with reasons for rejection and details of withdrawn or unsuccessful Applications, if any, to enable the SCSBs to unblock the respective bank accounts.
- b) On the basis of instructions from the Registrar to the Issue, the SCSBs may transfer the requisite amount against each successful Application to the Public Issue Account and may unblock the excess amount, if any, in the ASBA Account.
- c) In the event of withdrawal or rejection of the Application Form and for unsuccessful Applications, the Registrar to the Issue may give instructions to the SCSB to unblock the Application Amount in the relevant ASBA Account within six Working Days of the Issue Closing Date.



4.3.5.3 Discount (if applicable)

- a) The Discount is stated in absolute rupee terms.
- b) RIIs, Employees and Retail Individual Shareholders are only eligible for discount. For Discounts offered in the Issue, applicants may refer to the Prospectus.
- c) The Applicants entitled to the applicable Discount in the Issue may make payment for an amount i.e. the Application Amount less Discount (if applicable).

4.3.6 FIELD NUMBER 8: SIGNATURES AND OTHER AUTHORISATIONS & ACKNOWLEDGEMENT AND FUTURE COMMUNICATION

Applicants should refer to instructions contained in paragraphs 4.1.8 & 4.1.9.

4.4 SUBMISSION OF BID CUM APPLICATION FORM/REVISION FORM/APPLICATION FORM

4.4.1 Applicants may submit completed Bid cum application form/Revision Form in the following manner:-

Mode of Application	Submission of Bid cum Application Form
Anchor Investors Application Form	<ul style="list-style-type: none">• To the Book Running Lead Managers at the Specified Locations mentioned in the Bid cum Application Form
All Applications (other than Anchor Investors)	<ul style="list-style-type: none">• To members of the Syndicate in the Specified Locations or Registered Brokers at the Broker Centres or the RTA at the Designated RTA Location or the DP at the Designated DP Location• To the Designated Branches of the SCSBs where the ASBA Account is maintained

- a) Applicants should submit the Revision Form to the same Designated Intermediary through which such Applicant had placed the original Bid.
- b) Upon submission of the Bid cum Application Form, the Applicant will be deemed to have authorized the Issuer to make the necessary changes in the Prospectus and the Bid cum Application Form as would be required for filing Prospectus with the RoC and as would be required by the RoC after such filing, without prior or subsequent notice of such changes to the relevant Applicant.
- c) Upon determination of the Issue Price and filing of the Prospectus with the RoC, the Bid cum Application Form will be considered as the application form.

SECTION 5: ISSUE PROCEDURE IN BOOK BUILT ISSUE

Book Building, in the context of the Issue, refers to the process of collection of Bids within the Price Band or above the Floor Price and determining the Issue Price based on the Bids received as detailed in Schedule XI of SEBI ICDR Regulations, 2009. The Issue Price is finalised after the Bid/ Issue Closing Date. Valid Bids received at or above the Issue Price are considered for allocation in the Issue, subject to applicable regulations and other terms and conditions.

5.1 SUBMISSION OF BIDS

- a) During the Bid/ Issue Period, Applicants may approach any of the Designated Intermediaries to register their Bids. Anchor Investors who are interested in subscribing for the Equity Shares should approach the Book Running Lead Manager, to register their Bid.



- b) In case of Applicants (excluding NIIs and QIBs) Bidding at Cut-off Price, the Applicants may instruct the SCSBs to block Bid Amount based on the Cap Price less Discount (if applicable).
- c) For Details of the timing on acceptance and upload of Bids in the Stock Exchanges Platform Applicants are requested to refer to the Prospectus.

5.2 ELECTRONIC REGISTRATION OF BIDS

- a) The Designated Intermediary may register the Bids using the on-line facilities of the Stock Exchanges. The Designated Intermediaries can also set up facilities for off-line electronic registration of Bids, subject to the condition that they may subsequently upload the off-line data file into the on-line facilities for Book Building on a regular basis before the closure of the issue.
- b) On the Bid/ Issue Closing Date, the Designated Intermediaries may upload the Bids till such time as may be permitted by the Stock Exchanges.
- c) Only Bids that are uploaded on the Stock Exchanges Platform are considered for allocation/Allotment. The Designated Intermediaries are given till 1:00 pm on the day following the Bid/ Issue Closing Date to modify select fields uploaded in the Stock Exchange Platform during the Bid/ Issue Period after which the Stock Exchange(s) send the bid information to the Registrar to the Issue for further processing.

5.3 BUILD UP OF THE BOOK

- a) Bids received from various Applicants through the Designated Intermediaries may be electronically uploaded on the Bidding Platform of the Stock Exchanges' on a regular basis. The book gets built up at various price levels. This information may be available with the BRLMs at the end of the Bid/ Issue Period.
- b) Based on the aggregate demand and price for Bids registered on the Stock Exchanges Platform, a graphical representation of consolidated demand and price as available on the websites of the Stock Exchanges may be made available at the Bidding centres during the Bid/ Issue Period.

5.4 WITHDRAWAL OF BIDS

- a) RIIs can withdraw their Bids until Bid/ Issue Closing Date. In case a RII wishes to withdraw the Bid during the Bid/ Issue Period, the same can be done by submitting a request for the same to the concerned Designated Intermediary who shall do the requisite, including unblocking of the funds by the SCSB in the ASBA Account.
- b) The Registrar to the Issue shall give instruction to the SCSB for unblocking the ASBA Account on the Designated Date. QIBs and NIIs can neither withdraw nor lower the size of their Bids at any stage.

5.5 REJECTION & RESPONSIBILITY FOR UPLOAD OF BIDS

- a) The Designated Intermediaries are individually responsible for the acts, mistakes or errors or omission in relation to:
 - 1) the Bids accepted by the Designated Intermediaries,
 - 2) the Bids uploaded by the Designated Intermediaries, and
 - 3) the Bid cum application forms accepted but not uploaded by the Designated Intermediaries.
- b) The BRLMs and their affiliate Syndicate Members, as the case may be, may reject Bids if all the information required is not provided and the Bid cum Application Form is incomplete in any respect.



- c) The SCSBs shall have no right to reject Bids, except in case of unavailability of adequate funds in the ASBA account or on technical grounds.
- d) In case of QIB Bidders, only the (i) SCSBs (for Bids other than the Bids by Anchor Investors); and (ii) BRLMs and their affiliate Syndicate Members (only in the Specified Locations) have the right to reject bids. However, such rejection shall be made at the time of receiving the Bid and only after assigning a reason for such rejection in writing.
- e) All bids by QIBs, NIIs & RIIs Bids can be rejected on technical grounds listed herein.

5.5.1 GROUNDS FOR TECHNICAL REJECTIONS

Bid cum Application Forms/Application Form can be rejected on the below mentioned technical grounds either at the time of their submission to any of the Designated Intermediaries, or at the time of finalisation of the Basis of Allotment. Applicants are advised to note that the Bids/Applications are liable to be rejected, inter-alia, on the following grounds, which have been detailed at various places in this GID:-

- a) Bid/Application by persons not competent to contract under the Indian Contract Act, 1872, as amended, (other than minors having valid Depository Account as per Demographic Details provided by Depositories);
- b) Bids/Applications by OCBs; and
- c) In case of partnership firms, Bid/Application for Equity Shares made in the name of the firm. However, a limited liability partnership can apply in its own name;
- d) In case of Bids/Applications under power of attorney or by limited companies, corporate, trust etc., relevant documents not being submitted along with the Bid cum application form/Application Form;
- e) Bids/Applications by persons prohibited from buying, selling or dealing in the shares directly or indirectly by SEBI or any other regulatory authority;
- f) Bids/Applications by persons in the United States excluding persons who are a U.S. QIB (as defined in this Prospectus);
- g) Bids/Applications by any person outside India if not in compliance with applicable foreign and Indian laws;
- h) PAN not mentioned in the Bid cum Application Form/Application Form, except for Bids/Applications by or on behalf of the Central or State Government and officials appointed by the court and by the investors residing in the State of Sikkim, provided such claims have been verified by the Depository Participant;
- i) In case no corresponding record is available with the Depositories that matches the DP ID, the Client ID and the PAN;
- j) Bids/Applications for lower number of Equity Shares than the minimum specified for that category of investors;
- k) Bids/Applications at a price less than the Floor Price and Bids/Applications at a price more than the Cap Price;
- l) Bids/Applications at Cut-off Price by NIIs and QIBs;
- m) The amounts mentioned in the Bid cum Application Form/Application Form does not tally with the amount payable for the value of the Equity Shares Bid/Applied for;
- n) Bids/Applications for amounts greater than the maximum permissible amounts prescribed by the regulations;



- o) Submission of more than five Bid cum Application Forms/Application Form as through a single ASBA Account;
- p) Bids/Applications for number of Equity Shares which are not in multiples Equity Shares which are not in multiples as specified in the Prospectus;
- q) Multiple Bids/Applications as defined in this GID and the Prospectus;
- r) Bid cum Application Forms/Application Forms are not delivered by the Applicants within the time prescribed as per the Bid cum Application Forms/Application Form, Bid/ Issue Opening Date advertisement and as per the instructions in the Prospectus and the Bid cum Application Forms;
- s) Inadequate funds in the bank account to block the Bid/Application Amount specified in the Bid cum Application Form/Application Form at the time of blocking such Bid/Application Amount in the bank account;
- t) In case of Anchor Investors, Bids/Applications where sufficient funds are not available in Escrow Accounts as per final certificate from the Escrow Collection Banks;
- u) Where no confirmation is received from SCSB for blocking of funds;
- v) Bids/Applications by Bidders (other than Anchor Investors) not submitted through ASBA process;
- w) Bids/Applications submitted to a BRLM at locations other than the Specified Cities and Bid cum Application Forms/Application Forms, under the ASBA process, submitted to the Escrow Collecting Banks (assuming that such bank is not a SCSB where the ASBA Account is maintained), to the issuer or the Registrar to the Issue;
- x) Bids/Applications not uploaded on the terminals of the Stock Exchanges; and
- y) Bids/Applications by SCSBs wherein a separate account in its own name held with any other SCSB is not mentioned as the ASBA Account in the Bid cum Application Form/Application Form.

5.6 BASIS OF ALLOCATION

- a) The SEBI ICDR Regulations, 2009 specify the allocation or Allotment that may be made to various categories of Applicants in an Issue depending on compliance with the eligibility conditions. Certain details pertaining to the percentage of Issue size available for allocation to each category is disclosed overleaf of the Bid cum Application Form and in the Prospectus. For details in relation to allocation, the Applicant may refer to the Prospectus.
- b) Under-subscription in any category (except QIB Category) is allowed to be met with spillover from any other category or combination of categories at the discretion of the Issuer and in consultation with the BRLMs and the Designated Stock Exchange and in accordance with the SEBI ICDR Regulations, 2009. Unsubscribed portion in QIB Category is not available for subscription to other categories.
- c) In case of under subscription in the Issue, spill-over to the extent of such under-subscription may be permitted from the Reserved Portion to the Issue. For allocation in the event of an under-subscription applicable to the Issuer, Applicants may refer to the Prospectus.
- d) Illustration of the Book Building and Price Discovery Process Bidders should note that this example is solely for illustrative purposes and is not specific to the Issue; it also excludes Bidding by Anchor Investors.



Bidders can bid at any price within the Price Band. For instance, assume a Price Band of ₹ 20 to ₹ 24 per share, Issue size of 3,000 Equity Shares and receipt of five Bids from Bidders, details of which are shown in the table below. The illustrative book given below shows the demand for the Equity Shares of the Issuer at various prices and is collated from Bids received from various investors.

Bid Quantity	Bid Amount (₹)	Cumulative Quantity	Subscription
500	24	500	16.67%
1,000	23	1,500	50.00%
1,500	22	3,000	100.00%
2,000	21	5,000	166.67%
2,500	20	7,500	250.00%

The price discovery is a function of demand at various prices. The highest price at which the Issuer is able to Issue the desired number of Equity Shares is the price at which the book cuts off, i.e., ₹ 22.00 in the above example. The Issuer in consultation with the BRLMs, may finalise the Issue Price at or below such Cut-Off Price, i.e., at or below ₹ 22.00. All Bids at or above this Issue Price and cut-off Bids are valid Bids and are considered for allocation in the respective categories.

e) **Alternate Method of Book Building**

In case of FPOs, Issuers may opt for an alternate method of Book Building in which only the Floor Price is specified for the purposes of Bidding (“**Alternate Book Building Process**”).

The Issuer may specify the Floor Price in the Prospectus or advertise the Floor Price at least one Working Day prior to the Bid/ Issue Opening Date. QIBs may Bid at a price higher than the Floor Price and the Allotment to the QIBs is made on a price priority basis. The Bidder with the highest Bid Amount is allotted the number of Equity Shares Bid for and then the second highest Bidder is Allotted Equity Shares and this process continues until all the Equity Shares have been allotted. RIIs, NIIs and Employees are Allotted Equity Shares at the Floor Price and Allotment to these categories of Bidders is made proportionately. If the number of Equity Shares Bid for at a price is more than available quantity then the Allotment may be done on a proportionate basis. Further, the Issuer may place a cap either in terms of number of specified securities or percentage of issued capital of the Issuer that may be Allotted to a single Bidder, decide whether a Bidder be allowed to revise the bid upwards or downwards in terms of price and/or quantity and also decide whether a Bidder be allowed single or multiple bids.

SECTION 6: ISSUE PROCEDURE IN FIXED PRICE ISSUE

Applicants may note that there is no Bid cum Application Form in a Fixed Price Issue. As the Issue Price is mentioned in the Fixed Price Issue therefore on filing of the Prospectus with the RoC, the Application so submitted is considered as the Application Form.

Applicants may only use the specified Application Form for the purpose of making an Application in terms of the Prospectus which may be submitted through the Designated Intermediary.

Applicants may submit an Application Form either in physical form to the any of the Designated Intermediaries or in the electronic form to the SCSB or the Designated Branches of the SCSBs authorising blocking of funds that are available in the bank account specified in the Application Form only (“ASBA Account”). The Application Form is also made available on the websites of the Stock Exchanges at least one day prior to the Bid/ Issue Opening Date.

In a fixed price Issue, allocation in the net Issue to the public category is made as follows: minimum fifty per cent to Retail Individual Investors; and remaining to (i) individual investors other than Retail Individual Investors; and (ii) other Applicants including corporate bodies or institutions, irrespective of the number of specified securities applied



for. The unsubscribed portion in either of the categories specified above may be allocated to the Applicants in the other category.

For details of instructions in relation to the Application Form, Applicants may refer to the relevant section of the GID.

SECTION 7: ALLOTMENT PROCEDURE AND BASIS OF ALLOTMENT

The Allotment of Equity Shares to Applicants other than Retail Individual Investors and Anchor Investors may be on proportionate basis. For Basis of Allotment to Anchor Investors, Applicants may refer to Prospectus. No Retail Individual Investor will be Allotted less than the minimum Bid Lot subject to availability of shares in Retail Individual Investor Category and the remaining available shares, if any will be Allotted on a proportionate basis. The Issuer is required to receive a minimum subscription of 90% of the Issue (excluding any Issue for Sale of specified securities). However, in case the Issue is in the nature of Offer for Sale only, then minimum subscription may not be applicable.

7.1 ALLOTMENT TO RIIs

Bids received from the RIIs at or above the Issue Price may be grouped together to determine the total demand under this category. If the aggregate demand in this category is less than or equal to the Retail Category at or above the Issue Price, full Allotment may be made to the RIIs to the extent of the valid Bids. If the aggregate demand in this category is greater than the allocation to in the Retail Category at or above the Issue Price, then the maximum number of RIIs who can be Allotted the minimum Bid Lot will be computed by dividing the total number of Equity Shares available for Allotment to RIIs by the minimum Bid Lot (“**Maximum RII Allottees**”). The Allotment to the RIIs will then be made in the following manner:

- a) In the event the number of RIIs who have submitted valid Bids in the Issue is equal to or less than Maximum RII Allottees, (i) all such RIIs shall be Allotted the minimum Bid Lot; and (ii) the balance available Equity Shares, if any, remaining in the Retail Category shall be Allotted on a proportionate basis to the RIIs who have received Allotment as per (i) above for the balance demand of the Equity Shares Bid by them (i.e. who have Bid for more than the minimum Bid Lot).
- b) In the event the number of RIIs who have submitted valid Bids in the Issue is more than Maximum RII Allottees, the RIIs (in that category) who will then be Allotted minimum Bid Lot shall be determined on the basis of draw of lots.

7.2 ALLOTMENT TO NIIs

Bids received from NIIs at or above the Issue Price may be grouped together to determine the total demand under this category. The Allotment to all successful NIIs may be made at or above the Issue Price. If the aggregate demand in this category is less than or equal to the Non-Institutional Category at or above the Issue Price, full Allotment may be made to NIIs to the extent of their demand. In case the aggregate demand in this category is greater than the Non-Institutional Category at or above the Issue Price, Allotment may be made on a proportionate basis up to a minimum of the Non-Institutional Category.

7.3 ALLOTMENT TO QIBs

For the Basis of Allotment to Anchor Investors, Applicants may refer to the SEBI ICDR Regulations, 2009 or Prospectus. Bids received from QIBs Bidding in the QIB Category (net of Anchor Portion) at or above the Issue Price may be grouped together to determine the total demand under this category. The QIB Category may be available for Allotment to QIBs who have Bid at a price that is equal to or greater than the Issue Price. Allotment may be undertaken in the following manner:

- a) In the first instance allocation to Mutual Funds for up to 5% of the QIB Category may be determined as follows:
 - (i) In the event that Bids by Mutual Fund exceeds 5% of the QIB Category, allocation to Mutual Funds may be



done on a proportionate basis for up to 5% of the QIB Category; (ii) In the event that the aggregate demand from Mutual Funds is less than 5% of the QIB Category then all Mutual Funds may get full Allotment to the extent of valid Bids received above the Issue Price; and (iii) Equity Shares remaining unsubscribed, if any and not allocated to Mutual Funds may be available for Allotment to all QIBs as set out at paragraph 7.4(b) below;

- b) In the second instance, Allotment to all QIBs may be determined as follows: (i) In the event of oversubscription in the QIB Category, all QIBs who have submitted Bids above the Issue Price may be Allotted Equity Shares on a proportionate basis for up to 95% of the QIB Category; (ii) Mutual Funds, who have received allocation as per (a) above, for less than the number of Equity Shares Bid for by them, are eligible to receive Equity Shares on a proportionate basis along with other QIBs; and (iii) Under-subscription below 5% of the QIB Category, if any, from Mutual Funds, may be included for allocation to the remaining QIBs on a proportionate basis.

7.4 ALLOTMENT TO ANCHOR INVESTOR (IF APPLICABLE)

- a) Allocation of Equity Shares to Anchor Investors at the Anchor Investor Issue Price will be at the discretion of the issuer in consultation with the Investor Selling Shareholder and the BRLMs, subject to compliance with the following requirements:
- 1) not more than 60% of the QIB Category will be allocated to Anchor Investors;
 - 2) one-third of the Anchor Investor Portion shall be reserved for domestic Mutual Funds, subject to valid Bids being received from domestic Mutual Funds at or above the price at which allocation is being done to other Anchor Investors; and
 - 3) allocation to Anchor Investors shall be on a discretionary basis and subject to:
 - a maximum number of two Anchor Investors for allocation up to ₹10 crores;
 - a minimum number of two Anchor Investors and maximum number of 15 Anchor Investors for allocation of more than ₹ 10 crores and up to ₹ 250 crores subject to minimum Allotment of ₹ 5 crores per such Anchor Investor; and
 - a minimum number of five Anchor Investors and maximum number of 15 Anchor Investors for allocation of more than ₹ 250 crores, and an additional 10 Anchor Investors for every additional ₹ 250 crores or part thereof, subject to minimum Allotment of ₹ 5 crores per such Anchor Investor.
- b) A physical book is prepared by the Registrar on the basis of the Anchor Investor Application Forms received from Anchor Investors. Based on the physical book and at the discretion of the issuer in consultation with the BRLMs, selected Anchor Investors will be sent a CAN and if required, a revised CAN.
- c) **In the event that the Issue Price is higher than the Anchor Investor Issue Price:** Anchor Investors will be sent a revised CAN within one day of the Pricing Date indicating the number of Equity Shares allocated to such Anchor Investor and the pay-in date for payment of the balance amount. Anchor Investors are then required to pay any additional amounts, being the difference between the Issue Price and the Anchor Investor Issue Price, as indicated in the revised CAN within the pay-in date referred to in the revised CAN. Thereafter, the Allotment Advice will be issued to such Anchor Investors.
- d) **In the event the Issue Price is lower than the Anchor Investor Issue Price:** Anchor Investors who have been Allotted Equity Shares will directly receive Allotment Advice.



7.5 BASIS OF ALLOTMENT FOR QIBs (OTHER THAN ANCHOR INVESTORS), NIIs AND RESERVED CATEGORY IN CASE OF OVER-SUBSCRIBED ISSUE

In the event of the Issue being over-subscribed, the Issuer may finalise the Basis of Allotment in consultation with the Designated Stock Exchange in accordance with the SEBI ICDR Regulations, 2009.

The allocation may be made in marketable lots, on a proportionate basis as explained below:

- a) Bidders may be categorized according to the number of Equity Shares applied for;
- b) The total number of Equity Shares to be Allotted to each category as a whole may be arrived at on a proportionate basis, which is the total number of Equity Shares applied for in that category (number of Bidders in the category multiplied by the number of Equity Shares applied for) multiplied by the inverse of the over-subscription ratio;
- c) The number of Equity Shares to be Allotted to the successful Bidders may be arrived at on a proportionate basis, which is total number of Equity Shares applied for by each Bidder in that category multiplied by the inverse of the over-subscription ratio;
- d) In all Bids where the proportionate Allotment is less than the minimum Bid Lot decided per Bidder, the Allotment may be made as follows: the successful Bidders out of the total Bidders for a category may be determined by a draw of lots in a manner such that the total number of Equity Shares Allotted in that category is equal to the number of Equity Shares calculated in accordance with (b) above; and each successful Bidder may be Allotted a minimum of such Equity Shares equal to the minimum Bid Lot finalised by the Issuer;
- e) If the proportionate Allotment to a Bidder is a number that is more than the minimum Bid lot but is not a multiple of one (which is the marketable lot), the decimal may be rounded off to the higher whole number if that decimal is 0.5 or higher. If that number is lower than 0.5 it may be rounded off to the lower whole number. Allotment to all Bidders in such categories may be arrived at after such rounding off; and
- f) If the Equity Shares allocated on a proportionate basis to any category are more than the Equity Shares Allotted to the Bidders in that category, the remaining Equity Shares available for Allotment may be first adjusted against any other category, where the Allotted Equity Shares are not sufficient for proportionate Allotment to the successful Bidders in that category. The balance Equity Shares, if any, remaining after such adjustment may be added to the category comprising Bidders applying for minimum number of Equity Shares.

7.6 DESIGNATED DATE AND ALLOTMENT OF EQUITY SHARES

- a) Designated Date: On the Designated Date, the Escrow Collection Banks shall transfer the funds represented by allocation of Equity Shares to Anchor Investors from the Escrow Account, as per the terms of the Escrow Agreement, into the Public Issue Account with the Bankers to the Issue. The balance amount after transfer to the Public Issue Account shall be transferred to the Refund Account. Payments of refund to the Bidders applying in the Anchor Investor Portion shall be made from the Refund Account as per the terms of the Escrow Agreement and the Prospectus. On the Designated Date, the Registrar to the Issue shall instruct the SCSBs to transfer funds represented by allocation of Equity Shares from ASBA Accounts into the Public Issue Account.
- b) Issuance of Allotment Advice: Upon approval of the Basis of Allotment by the Designated Stock Exchange, the Registrar shall upload the same on its website. On the basis of the approved Basis of Allotment, the Issuer shall pass necessary corporate action to facilitate the Allotment and credit of Equity Shares. Applicants are advised to instruct their Depository Participant to accept the Equity Shares that may be allotted to them pursuant to the Issue.
Pursuant to confirmation of such corporate actions, the Registrar will dispatch Allotment Advice to the Applicants who have been Allotted Equity Shares in the Issue.



- c) The dispatch of Allotment Advice shall be deemed a valid, binding and irrevocable contract.
- d) Issuer will ensure that: (i) the Allotment of Equity Shares; and (ii) credit of shares to the successful Applicants Depository Account will be completed within six Working Days of the Bid/ Issue Closing Date. The Issuer also ensures the credit of shares to the successful Applicant's depository account is completed within two Working Days from the date of Allotment.

SECTION 8: INTEREST AND REFUNDS

8.1 COMPLETION OF FORMALITIES FOR LISTING & COMMENCEMENT OF TRADING

The Issuer may ensure that all steps for the completion of the necessary formalities for listing and commencement of trading at all the Stock Exchanges are taken within six Working Days of the Bid/ Issue Closing Date. The Registrar to the Issue may give instructions for credit to Equity Shares the beneficiary account with CDPs, and dispatch the Allotment Advice within six Working Days of the Bid/ Issue Closing Date.

8.2 GROUNDS FOR REFUND

8.2.1 NON RECEIPT OF LISTING PERMISSION

An Issuer makes an application to the Stock Exchange(s) for permission to deal in/list and for an official quotation of the Equity Shares. All the Stock Exchanges from where such permission is sought are disclosed in Prospectus. The Designated Stock Exchange may be as disclosed in the Prospectus with which the Basis of Allotment may be finalised.

If the Issuer fails to make application to the Stock Exchange(s) or obtain permission for listing of the Equity Shares, in accordance with the provisions of Section 40 of the Companies Act, 2013, the Issuer shall be punishable with a fine which shall not be less than ₹ 5 lakhs but which may extend to ₹ 50 lakhs and every officer of the Issuer who is in default shall be punishable with imprisonment for a term which may extend to one year or with fine which shall not be less than ₹ 50,000 but which may extend to ₹ 3 lakhs, or with both.

If the permissions to deal in and for an official quotation of the Equity Shares are not granted by any of the Stock Exchange(s), the Issuer may forthwith take steps to refund, without interest, all moneys received from Applicants.

If such money is not refunded to the Bidders within the prescribed time after the Issuer becomes liable to repay it, then the Issuer and every director of the Issuer who is an officer in default may, on and from such expiry of such period, be liable to repay the money, with interest at such rate, as disclosed in the Prospectus.

8.2.2 NON RECEIPT OF MINIMUM SUBSCRIPTION

If the Issuer does not receive a minimum subscription of 90% of the Net Issue (excluding any offer for sale of specified securities), including devolvement to the Underwriters, the Issuer may forthwith, take steps to unblock the entire subscription amount received within six Working Days of the Bid/ Issue Closing Date and repay, without interest, all moneys received from Anchor Investors. In case the Issue is in the nature of Offer for Sale only, then minimum subscription may not be applicable. In case of under-subscription in the Issue, the Equity Shares in the Fresh Issue will be issued prior to the sale of Equity Shares in the Offer for Sale.

If there is a delay beyond the prescribed time after the Issuer becomes liable to pay or unblock the amount received from Bidders, then the Issuer and every director of the Issuer who is an officer in default may on and from expiry of 15 Days, be jointly and severally liable to repay the money, with interest at the rate of 15% per annum in accordance with the Companies (Prospectus and Allotment of Securities) Rules, 2014, as amended.



8.2.3 MINIMUM NUMBER OF ALLOTTEES

The Issuer may ensure that the number of prospective Allottees to whom Equity Shares may be Allotted may not be less than 1,000 failing which the entire application monies may be refunded forthwith.

8.2.4 IN CASE OF ISSUES MADE UNDER COMPULSORY BOOK BUILDING

In case an Issuer not eligible under Regulation 26(1) of the SEBI ICDR Regulations, 2009 comes for an Issue under Regulation 26(2) of SEBI (ICDR) Regulations, 2009 but fails to Allot at least 75% of the Net Issue to QIBs, in such case full subscription money is to be refunded.

8.3 MODE OF REFUND

- a) **In case of Bids/Applications (other than Anchor Investors):** Within six Working Days of the Bid/ Issue Closing Date, the Registrar to the Issue may give instructions to SCSBs for unblocking the amount in ASBA Account on unsuccessful Bid/Application and also for any excess amount blocked on Bidding/Application.
- b) **In case of Anchor Investors:** Within six Working Days of the Bid/ Issue Closing Date, the Registrar to the Issue may dispatch the refund orders for all amounts payable to unsuccessful Anchor Investors.
- c) In case of Anchor Investors, the Registrar to the Issue may obtain from the depositories, the Applicants' bank account details, including the MICR code, on the basis of the DP ID, Client ID and PAN provided by the Anchor Investors in their Anchor Investor Application Forms for refunds. Accordingly, Anchor Investors are advised to immediately update their details as appearing on the records of their depositories. Failure to do so may result in delays in dispatch of refund orders or refunds through electronic transfer of funds, as applicable, and any such delay may be at the Anchor Investors' sole risk and neither the Issuer, the Registrar to the Issue, the Escrow Collection Banks, or the Syndicate, may be liable to compensate the Anchor Investors for any losses caused to them due to any such delay, or liable to pay any interest for such delay. Please note that refunds shall be credited only to the bank account from which the Bid Amount was remitted to the Escrow Bank.

8.3.1 Electronic mode of making refunds for Anchor Investors

The payment of refund, if any, may be done through various electronic modes as mentioned below:

- a) **NEFT** - Payment of refund may be undertaken through NEFT wherever the branch of the Anchor Investors' bank is NEFT enabled and has been assigned the Indian Financial System Code ("IFSC"), which can be linked to the MICR of that particular branch. The IFSC Code may be obtained from the website of RBI as at a date prior to the date of payment of refund, duly mapped with MICR numbers. Wherever the Anchor Investors have registered their nine digit MICR number and their bank account number while opening and operating the demat account, the same may be duly mapped with the IFSC Code of that particular bank branch and the payment of refund may be made to the Anchor Investors through this method. In the event NEFT is not operationally feasible, the payment of refunds may be made through any one of the other modes as discussed in this section;
- b) **Direct Credit** - Anchor Investors having their bank account with the Refund Banker may be eligible to receive refunds, if any, through direct credit to such bank account;
- c) **RTGS** - Anchor Investors having a bank account at any of the centers notified by SEBI where clearing houses are managed by the RBI, may have the option to receive refunds, if any, through RTGS; and

Please note that refunds through the abovementioned modes shall be credited only to the bank account from which the Bid Amount was remitted to the Escrow Bank.



For details of levy of charges, if any, for any of the above methods, Bank charges, if any, for cashing such cheques, pay orders or demand drafts at other centers, etc. Anchor Investors may refer to Prospectus.

8.4 INTEREST IN CASE OF DELAY IN ALLOTMENT OR REFUND

The Issuer may pay interest at the rate of 15% per annum where the refund or portion thereof is made in electronic manner, the refund instructions have not been given to the clearing system in the disclosed manner and/or demat credits are not made to Applicants or instructions for unblocking of funds in the ASBA Account are not dispatched within the 6 working days of the Bid/ Issue Closing Date.

The Issuer may pay interest at 15% per annum for any delay beyond 15 days from the Bid/ Issue Closing Date, if Allotment is not made.

SECTION 9: GLOSSARY AND ABBREVIATIONS

Unless the context otherwise indicates or implies, certain definitions and abbreviations used in this document may have the meaning as provided below References to any legislation, act or regulation may be to such legislation, act or regulation as amended from time to time.

Term	Description
Allotment/Allot/Allotted	The allotment of Equity Shares pursuant to the Issue to successful Applicants
Allotment Advice	Note or advice or intimation of Allotment sent to the Applicants who have been Allotted Equity Shares after the Basis of Allotment has been approved by the designated Stock Exchanges
Allottee	An Applicant to whom the Equity Shares are Allotted
Anchor Investor	A Qualified Institutional Buyer, applying under the Anchor Invest or Portion in accordance with the requirements specified in SEBI ICDR Regulations, 2009 and the Prospectus.
Anchor Investor Application Form	The form used by an Anchor Investor to make a Bid in the Anchor Investor Portion and which will be considered as an application for Allotment in terms of the Prospectus
Anchor Investor Portion	Up to 60% of the QIB Category which may be allocated by the Issuer in consultation with the BRLMs, to Anchor Investors on a discretionary basis. One-third of the Anchor Investor Portion is reserved for domestic Mutual Funds, subject to valid Bids being received from domestic Mutual Funds at or above the price at which allocation is being done to Anchor Investors
Applicant	Any prospective investor who makes a Bid pursuant to the terms of the Prospectus and the Bid cum Application Form. In case of issues undertaken through the fixed price process, all references to a Applicant should be construed to mean an Applicant
Application Form	The form in terms of which the Applicant should make an application for Allotment in case of issues other than Book Built Issues, includes Fixed Price Issue
Application Supported by Blocked Amount/ASBA	An application, whether physical or electronic, used by Applicants, other than Anchor Investors, to make a Bid and authorising an SCSB to block the Bid Amount in the specified bank account maintained with such SCSB
ASBA Account	Account maintained with an SCSB which may be blocked by such SCSB to the extent of the Bid Amount of the Applicant
Banker(s) to the Issue / Escrow Collection Bank(s) / Collecting Banker	The banks which are clearing members and registered with SEBI as Banker to the Issue with whom the Escrow Account(s) for Anchor Investors may be opened ,and as disclosed in the Prospectus and Bid cum Application Form of the Issuer
Basis of Allotment	The basis on which the Equity Shares may be Allotted to successful Applicants under the Issue
Bid	An indication to make an Issue during the Bid/Issue Period by a prospective Bidder



Term	Description
	pursuant to submission of Bid cum Application Form or during the Anchor Investor Bid/Issue Period by the Anchor Investors, to subscribe for or purchase the Equity Shares of the Issuer at a price within the Price Band, including all revisions and modifications there to. In case of issues undertaken through the fixed price process, all references to a Bid should be construed to mean an Application
Bid Amount	The highest value of the optional Bids indicated in the Bid cum Application Form and payable by the Applicant up on submission of the Bid(except for Anchor Investors), less discounts (if applicable). In case of issues undertaken through the fixed price process, all references to the Bid Amount should be construed to mean the Application Amount
Bid/Issue Closing Date	Except in the case of Anchor Investors (if applicable), the date after which the Designated Intermediaries may not accept any Bids for the Issue, which may be notified in an English national daily, a Hindi national daily and a regional language news paper at the place where the registered office of the Issuer is situated, each with wide circulation. Applicants may refer to the Prospectus for the Bid/Issue Closing Date
Bid/Issue Opening Date	The date on which the Designated Intermediaries may start accepting Bids for the Issue, which may be the date notified in an English national daily, a Hindi national daily and a regional language newspaper at the place where the registered office of the Issuer is situated, each with wide circulation. Applicants may refer to the Prospectus for the Bid/Issue Opening Date
Bid/Issue Period	Except in the case of Anchor Investors(if applicable),the period between the Bid/Issue Opening Date and the Bid/Issue Closing Date inclusive of both days and during which prospective Applicants (other than Anchor Investors) can submit their Bids, inclusive of any revisions thereof. The Issuer may consider closing the Bid/Issue Period for QIBs one working day prior to the Bid/Issue Closing Date in accordance with the SEBI ICDRRegulations,2009. Applicants may refer to the Prospectus for the Bid/Issue Period
Bid cum Application Form	An application form, whether physical or electronic, used by Bidders, other than Anchor Investors, to make a Bid and which will be considered as the application for Allotment in terms of the Red Herring Prospectus and the Prospectus
Book Built Process / Book Building Process / Book Building Method	The book building process as provided under SEBI ICDR Regulations, 2009, in terms of which the Issue is being made
Broker Centres	Broker centres notified by the Stock Exchanges, where Applicants can submit the Bid cum Application Forms to a Registered Broker. The details of such broker centres, along with the names and contact details of the Registered Brokers are available on the websites of the Stock Exchanges.
BRLM(s) / Book Running Lead Manager(s) / Lead Manager / LM	The Book Running Lead Manager to the Issue as disclosed in the Prospectus and the Bid cum Application Form of the Issuer. In case of issues undertaken through the fixed price process, all references to the Book Running Lead Manager should be construed to mean the Lead Manager or LM
Business Day	Monday to Saturday (except 2nd & 4th Saturday of a month and public holidays)
CAN / Confirmation of Allotment Note	The note or advice or intimation sent to each successful Applicant indicating the Equity Shares which may be Allotted, after approval of Basis of Allotment by the Designated Stock Exchange
Cap Price	The higher end of the Price Band, above which the Issue Price and the Anchor Investor Issue Price may not be finalised and above which no Bids may be accepted
Client ID	Client Identification Number maintained with one of the Depositories in relation to demat account
Collecting Depository	A depository participant as defined under the Depositories Act, 1996, registered



Term	Description
Participant or CDPs	with SEBI and who is eligible to procure Bids at the Designated CDP Locations in terms of circular no. CIR/CFD/POLICYCELL/11/2015 dated November 10, 2015 issued by SEBI
Cut-off Price	Issue Price, finalised by the Issuer in consultation with the Book Running Lead Manager(s), which can be any price within the Price Band. Only RIIs, Retail Individual Shareholders and employees are entitled to Bid at the Cut-off Price. No other category of Applicants are entitled to Bid at the Cut-off Price
DP	Depository Participant
DP ID	Depository Participant's Identification Number
Depositories	National Securities Depository Limited and Central Depository Services (India) Limited
Demographic Details	Details of the Applicants including the Applicant's address, name of the Applicant's father/husband, investor status, occupation and bank account details
Designated Branches	Such branches of the SCSBs which may collect the Bid cum Application Forms used by Applicants (exc Anchor Investor) and a list of which is available on http://www.sebi.gov.in/cms/sebi_data/attachdocs/1316087201341.html
Designated CDP Locations	Such locations of the CDPs where Bidders can submit the Bid cum Application Forms to Collecting Depository Participants. The details of such Designated CDP Locations, along with names and contact details of the Collecting Depository Participants eligible to accept Bid cum Application Forms are available on the respective websites of the Stock Exchanges (www.bseindia.com and www.nseindia.com)
Designated Date	The date on which funds are transferred by the Escrow Collection Bank(s) from the Escrow Account and the amounts blocked by the SCSBs are transferred from the ASBA Accounts, as the case may be, to the Public Issue Account or the Refund Account, as appropriate, after the Prospectus is filed with the RoC, following which the board of directors may Allot Equity Shares to successful Applicants in the Fresh Issue may give delivery instructions for the transfer of the Equity Shares constituting the Offer for Sale
Designated Intermediaries / Collecting Agent	Syndicate Members, Sub-Syndicate/Agents, SCSBs, Registered Brokers, Brokers, the CDPs and RTAs, who are authorized to collect Bid cum Application Forms from the Bidders, in relation to the Issue
Designated RTA Locations	Such locations of the RTAs where Bidders can submit the Bid cum Application Forms to RTAs. The details of such Designated RTA Locations, along with names and contact details of the RTAs eligible to accept Bid cum Application Forms are available on the respective websites of the Stock Exchanges (www.bseindia.com and www.nseindia.com)
Designated Stock Exchange	The designated stock exchange as disclosed in the Prospectus of the Issuer
Discount	Discount to the Issue Price that may be provided to Bidders/Applicants in accordance with the SEBI ICDR Regulations, 2009.
Prospectus	The Prospectus filed with SEBI in case of Fixed Price Issues and which may mention a price or a Price Band
Employees	Employees of an Issuer as defined under SEBI ICDR Regulations, 2009 and including, in case of a new company, persons in the permanent and full time employment of the promoting companies excluding the promoters and immediate relatives of the promoters. For further details, Bidder/Applicant may refer to the Prospectus
Equity Shares	Equity Shares of the Issuer
Escrow Account	Account opened with the Escrow Collection Bank(s) and in whose favour the



Term	Description
	Anchor Investors may issue cheques or demand drafts or transfer money through NEFT or RTGS in respect of the Bid Amount when submitting a Bid
Escrow Agreement	Agreement to be entered into among the Issuer, the Registrar to the Issue, the Book Running Lead Manager(s), the Syndicate Member(s), the Escrow Collection Bank(s) and the Refund Bank(s) for collection of the Bid Amounts from Anchor Investors and where applicable, remitting refunds of the amounts collected to the Anchor Investors on the terms and conditions thereof
Escrow Collection Bank(s)	Refer to definition of Banker(s) to the Issue
FCNR Account	Foreign Currency Non-Resident Account
First Applicant	The Applicant whose name appears first in the Bid cum Application Form or Revision Form
FII(s)	Foreign Institutional Investors as defined under the SEBI (Foreign Institutional Investors) Regulations, 1995 and registered with SEBI under applicable laws in India
Fixed Price Issue / Fixed Price Process / Fixed Price Method	The Fixed Price process as provided under SEBI ICDR Regulations, 2009, in terms of which the Issue is being made
Floor Price	The lower end of the Price Band, at or above which the Issue Price and the Anchor Investor Issue Price may be finalised and below which no Bids may be accepted, subject to any revision thereto
FPIs	Foreign Portfolio Investors as defined under the Securities and Exchange Board of India (Foreign Portfolio Investors) Regulations, 2014
FPO	Further public offering
Foreign Venture Capital Investors or FVCIs	Foreign Venture Capital Investors as defined and registered with SEBI under the SEBI (Foreign Venture Capital Investors) Regulations, 2000
IPO	Initial public offering
Issuer/Company	The Issuer proposing the initial public offering/further public offering as applicable
Maximum RII Allottees	The maximum number of RIIs who can be Allotted the minimum Bid Lot. This is computed by dividing the total number of Equity Shares available for Allotment to RIIs by the minimum Bid Lot.
MICR	Magnetic Ink Character Recognition - nine-digit code as appearing on a cheque leaf
Mutual Fund	A mutual fund registered with SEBI under the SEBI (Mutual Funds) Regulations, 1996
Mutual Funds Portion	5% of the QIB Category (excluding the Anchor Investor Portion) available for allocation to Mutual Funds only, being such number of equity shares as disclosed in the Prospectus and Bid cum Application Form
NEFT	National Electronic Fund Transfer
NRE Account	Non-Resident External Account
NRI	NRIs from such jurisdictions outside India where it is not unlawful to make an Issue or invitation under the Issue and in relation to whom the Prospectus constitutes an invitation to subscribe to or purchase the Equity Shares
NRO Account	Non-Resident Ordinary Account
Net Issue	The Issue less reservation portion
Non-Institutional Investors or NIIs	All Applicants, including sub accounts of FIIs registered with SEBI which are foreign corporates or foreign individuals and FPIs which are Category III foreign portfolio investors, that are not QIBs or RIBs and who have Bid for Equity Shares for an amount of more than ₹ 200,000 (but not including NRIs other than Eligible NRIs)
Non-Institutional Category	The portion of the Issue being such number of Equity Shares available for allocation to NIIs on a proportionate basis and as disclosed in the Prospectus and the Bid cum Application Form
Non-Resident	A person resident outside India, as defined under FEMA and includes Eligible



Term	Description
	NRIs, FPIs and FVCIs registered with SEBI
OCB/Overseas Corporate Body	A company, partnership, society or other corporate body owned directly or indirectly to the extent of at least 60% by NRIs including overseas trusts, in which not less than 60% of beneficial interest is irrevocably held by NRIs directly or indirectly and which was in existence on October 3, 2003 and immediately before such date had taken benefits under the general permission granted to OCBs under FEMA
Issue	Public issue of Equity Shares of the Issuer including the Offer for Sale if applicable
Offer for Sale	Public offer of such number of Equity Shares as disclosed in the Prospectus through an offer for sale by the Selling Shareholders
Other Investors	Investors other than Retail Individual Investors in a Fixed Price Issue. These include individual applicants other than retail individual investors and other investors including corporate bodies or institutions irrespective of the number of specified securities applied for
Issue Price	The final price, less discount (if applicable) at which the Equity Shares may be Allotted to Bidders other than Anchor Investors, in terms of the Prospectus. Equity Shares will be Allotted to Anchor Investors at the Anchor Investor Issue Price The Issue Price may be decided by the Issuer in consultation with the Book Running Lead Manager(s)
PAN	Permanent Account Number allotted under the Income Tax Act, 1961
Price Band	Price Band with a minimum price, being the Floor Price and the maximum price, being the Cap Price and includes revisions thereof. The Price Band and the minimum Bid lot size for the Issue may be decided by the Issuer in consultation with the Book Running Lead Manager(s) and advertised, at least five working days in case of an IPO and one working day in case of FPO, prior to the Bid/Issue Opening Date, in English national daily, Hindi national daily and regional language at the place where the registered office of the Issuer is situated, newspaper each with wide circulation
Pricing Date	The date on which the Issuer in consultation with the Book Running Lead Manager(s), finalise the Issue Price
Prospectus	The prospectus to be filed with the RoC in accordance with Section 26 of the Companies Act, 2013 after the Pricing Date, containing the Issue Price, the size of the Issue and certain other information
Public Issue Account	An account opened with the Banker to the Issue to receive monies from the Escrow Account and from the ASBA Accounts on the Designated Date
QIB Category	The portion of the Issue being such number of Equity Shares to be Allotted to QIBs on a proportionate basis
Qualified Institutional Buyers or QIBs	As defined under SEBI ICDR Regulations, 2009
RTGS	Real Time Gross Settlement
Refund Account(s)	The account opened with Refund Bank(s), from which refunds to Anchor Investors, if any, of the whole or part of the Bid Amount may be made
Refund Bank(s)	Refund bank(s) as disclosed in the Prospectus and Bid cum Application Form of the Issuer
Refunds through electronic transfer of funds	Refunds through Direct Credit, NEFT, RTGS or ASBA, as applicable
Registrar and Share Transfer Agents or RTAs	Registrar and share transfer agents registered with SEBI and eligible to procure Bids at the Designated RTA Locations in terms of circular no. CIR/CFD/POLICYCELL/11/2015 dated November 10, 2015 issued by SEBI
Registered Broker	Stock Brokers registered with the Stock Exchanges having nationwide terminals, other than the members of the Syndicate
Registrar to the Issue/RTO	The Registrar to the Issue as disclosed in the Prospectus and Bid cum Application



Term	Description
	Form
Reserved Category / Categories	Categories of persons eligible for making application/Bidding under reservation portion
Reservation Portion	The portion of the Issue reserved for such category of eligible Applicants as provided under the SEBI ICDR Regulations, 2009
Retail Individual Investors/RIIs	Investors who applies or bids for a value of not more than ₹ 200,000 (including HUFs applying through their karta and eligible NRIs and does not include NRIs other than Eligible NRIs.
Retail Individual Shareholders	Shareholders of a listed Issuer who applies or bids for a value of not more than ₹ 200,000.
Retail Category	The portion of the Issue being such number of Equity Shares available for allocation to RIIs which shall not be less than the minimum Bid Lot, subject to availability in RII category and the remaining shares to be Allotted on proportionate basis.
Revision Form	The form used by the Applicants, including ASBA Applicants, in an issue through Book Building Process to modify the quantity of Equity Shares and/or bid price indicated therein in any of their Bid cum Application Forms or any previous Revision Form(s)
RoC	The Registrar of Companies
SEBI	The Securities and Exchange Board of India constituted under the Securities and Exchange Board of India Act, 1992
SEBI ICDR Regulations, 2009	The Securities and Exchange Board of India (Issue of Capital and Disclosure Requirements) Regulations, 2009
Self Certified Syndicate Bank(s) or SCSB(s)	A bank registered with SEBI, which Issues the facility of ASBA and a list of which is available on http://www.sebi.gov.in/cms/sebi_data/attachdocs/1316087201341.html
Specified Locations	Bidding centres where the Syndicate shall accept Bid cum Application Forms, a list of which is available on the website of SEBI at http://www.sebi.gov.in/ And updated from time to time
Stock Exchanges / SE	The stock exchanges as disclosed in the Prospectus of the Issuer where the Equity Shares Allotted pursuant to the Issue are proposed to be listed
Syndicate	The Book Running Lead Manager(s) and the Syndicate Member
Syndicate Agreement	The agreement to be entered into among the Issuer, and the Syndicate in relation to collection of Bid cum Application Forms by Syndicate Members
Syndicate Member(s) / SM	The Syndicate Member(s) as disclosed in the Prospectus
Underwriters	The Book Running Lead Manager(s) and the Syndicate Member(s)
Underwriting Agreement	The agreement amongst the Issuer, and the Underwriters to be entered into on or after the Pricing Date
Working Day	Any day, other than 2nd and 4th Saturday of the month, Sundays or public holidays, on which commercial banks in Mumbai are open for business, provided however, with reference to (a) announcement of Price Band; and (b) Bid/Issue Period, "Working Days" shall mean all days, excluding Saturdays, Sundays and public holidays, which are working days for commercial banks in India.



RESTRICTIONS ON FOREIGN OWNERSHIP OF INDIAN SECURITIES

Foreign investment in Indian securities is regulated through the Industrial Policy, 1991 of the Government of India and FEMA. While the Industrial Policy, 1991 prescribes the limits and the conditions subject to which foreign investment can be made in different sectors of the Indian economy, FEMA regulates the precise manner in which such investment may be made. Under the Industrial Policy, unless specifically restricted, foreign investment is freely permitted in all sectors of Indian economy up to any extent and without any prior approvals, but the foreign investor is required to follow certain prescribed procedures for making such investment. The government bodies responsible for granting foreign investment approvals are FIPB and the RBI.

The Government has from time to time made policy pronouncements on FDI through press notes and press releases. The Department of Industrial Policy and Promotion, Ministry of Commerce and Industry, Government of India (“DIPP”), issued consolidated FDI Policy, which with effect from August 28, 2017 consolidates and supersedes all previous press notes, press releases and clarifications on FDI issued by the DIPP that were in force and effect as on August 27, 2017. The Government proposes to update the consolidated circular on FDI Policy once every year and therefore, the Consolidation FDI Policy will be valid until the DIPP issues an updated circular.

The transfer of shares by an Indian resident to a Non-Resident does not require the prior approval of the FIPB or the RBI, provided that (i) the activities of the investee company are under the automatic route under the Consolidated FDI Policy and transfer does not attract the provisions of the SEBI (Substantial Acquisition of Shares and Takeovers) Regulations, 2011; (ii) the non-resident shareholding is within the sectoral limits under the Consolidated FDI Policy; and (iii) the pricing is in accordance with the guidelines prescribed by SEBI/RBI.

As per the existing policy of the Government of India, OCBs cannot participate in this Issue. The Equity Shares offered in the Issue have not been and will not be registered under the Securities Act, and may not be offered or sold within the United States, except pursuant to an exemption from, or in a transaction not subject to, the registration requirements of the Securities Act and applicable U.S. state securities laws. Accordingly, the Equity Shares are being offered and sold (i) within the United States to persons reasonably believed to be “qualified institutional investors” (as defined in Rule 144A under the Securities Act) pursuant to Rule 144A under the Securities Act or other applicable exemption under the Securities Act and (ii) outside the United States in offshore transactions in reliance on Regulation S under the Securities Act and the applicable laws of the jurisdictions where such offers and sales occur.

The above information is given for the benefit of the Applicants. Our Company and the LM are not liable for any amendments or modification or changes in applicable laws or regulations, which may occur after the date of this Prospectus. Applicants are advised to make their independent investigations and ensure that the Applications are not in violation of laws or regulations applicable to them.



SECTION X – MAIN PROVISION OF ARTICLES OF ASSOCIATION

Capitalised terms used in this section have the meaning that has been given to such terms in the Articles of Association of our Company. Pursuant to Table F in Schedule I of the Companies Act, 2013 and the SEBI Regulations, the main provisions of the Articles of Association of our Company are detailed below:

These Articles of Association were adopted in substitution for and to the entire exclusion of the earlier Articles of Association at the Extra-ordinary General Meeting of the Company held on November 30, 2017.

1. The regulations contained in Table 'F' of the First Schedule of the Companies Act, 2013 so far as they are applicable to Public Company limited by shares, shall apply to this Company save in so far as they are expressly or impliedly excluded by the following Articles.

Interpretation

2. In the interpretation of these Articles, unless repugnant to the subject or context:-
 - a) "The company" or "this company" means **SAKETH EXIM LIMITED**
 - b) "The Act" means the Companies Act 2013, or any statutory modification or re- enactment thereof for the time being in force.
 - c) "Auditor" means and includes those persons appointed as such for the time being by the Company.
 - d) "Board Meeting" means meeting of the Directors duly and constituted or as the case may be, the Directors assembled at a Board.
 - e) "Capital" means the share capital for the time being raised or authorized to be raised, for the Company.
 - f) "Debenture" includes the Debenture stock.
 - g) "Directors" mean the Directors for the time being of the Company of as the case may be the Directors assembled at as Board.
 - h) "Dividend" includes bonus.
 - i) Gender Word importing the masculine gender also includes the feminine gender.
 - j) "In Writing" or "Written" includes printing, lithography and other modes of representing or reproducing words in a visible form.
 - k) "Member" means the duly registered holder from time to time of the shares of the Company and includes the subscriber to the Memorandum of the Company.
 - l) "Annual General Meeting" means a General Meeting of the members duly called and constituted and any adjourned holding thereof in accordance of section 96 of the Act.
 - m) Meeting or Extraordinary general meeting "Extraordinary General Meeting" means Extraordinary General meeting of the Members duly called and constituted and any adjourned holding thereof.
 - n) Month means a calendar month
 - o) Office means the registered office for the time being of the Company.



- p) “Paid up” includes credited as paid up.
- q) “Persons” includes corporation and firms as well as individuals.
- r) “Register of member” means the Register of members to be kept pursuant to the Act.
- s) “The Registrar” means the Registrar of the Companies (as defined under Section 2(75) of the Act of the state in which the office of the Company is for the time being situated.
- t) *Officer* includes any director, manager or secretary, or any person in accordance with whose direction or instruction the board of Director or any or more of the directors is accustomed to act
- u) *Seal* means the Common Seal for the time being of the Company.
- v) *Share* means share in the share capital of a company and includes stock except where a distinction between stock and share is expressed or implied.
- w) *Special Resolution* shall have the meaning assigned thereto by section 114 of Companies Act, 2013.
- x) *Year and Financial Year* means the calendar year and “financial year” shall have the meaning assigned thereto by section 2(41) of the Act.

Public Company

- 3. The company is a Public Company within the meaning of section 2(71) of the Companies Act, 2013.

Share capital and variation of rights

- 4. (i) The Authorised Share Capital of the Company shall be as laid down in Memorandum of Association of the Company.
- (ii) Subject to the provisions of the Companies Act 2013 and the applicable Rules made thereunder, the Company / Board shall have power to issue / allot shares, whether on preferential basis or otherwise, from time to time and the shares shall be under the control of the Directors who may allot or otherwise dispose off the same to such persons, on such terms and conditions and at such times as the Directors think fit.
- 5. (i) Every person whose name is entered as a member in the register of members shall be entitled to receive within two months after incorporation, in case of subscribers to the memorandum or after allotment or within one month after the application for the registration of transfer or transmission or within such other period as the conditions of issue shall be provided:—
 - (a) One certificate for all his shares without payment of any charges; or
 - (b) Several certificates, each for one or more of his shares, upon payment of twenty rupees for each certificate after the first.
- (ii) Every certificate shall be under the seal and shall specify the shares to which it relates and the amount paid-up thereon.
- (iii) In respect of any share or shares held jointly by several persons, the company shall not be bound to issue more than one certificate, and delivery of a certificate for a share to one of several joint holders shall be sufficient delivery to all such holders.



6. (i) If any share certificate be worn out, defaced, mutilated or torn or if there be no further space on the back for endorsement of transfer, then upon production and surrender thereof to the company, a new certificate may be issued in lieu thereof, and if any certificate is lost or destroyed then upon proof thereof to the satisfaction of the company and on execution of such indemnity as the company deem adequate, a new certificate in lieu thereof shall be given. Every certificate under this Article shall be issued on payment of twenty rupees for each certificate.

(ii) The company may issue new share certificates pursuant to consolidation or sub division of share certificate(s) upon written request received from shareholder together with production and surrender of respective original share certificate(s). Every certificate under this Article shall be issued on payment of twenty rupees for each certificate.

(iii) The provisions of Articles (5) and (6) shall mutatis mutandis apply to debentures of the company.
7. Except as required by law, no person shall be recognized by the company as holding any share upon any trust, and the company shall not be bound by, or be compelled in any way to recognize (even when having notice thereof) any equitable, contingent, future or partial interest in any share, or any interest in any fractional part of a share, or (except only as by these regulations or by law otherwise provided) any other rights in respect of any share except an absolute right to the entirety thereof in the registered holder.
8. (i) The company may exercise the powers of paying commissions conferred by sub-section (6) of section 40, provided that the rate per cent. or the amount of the commission paid or agreed to be paid shall be disclosed in the manner required by that section and rules made thereunder.

(ii) The rate or amount of the commission shall not exceed the rate or amount prescribed in rules made under sub-section (6) of section 40.

(iii) The commission may be satisfied by the payment of cash or the allotment of fully or partly paid shares or partly in the one way and partly in the other.
9. (i) If at any time the share capital is divided into different classes of shares, the rights attached to any class (unless otherwise provided by the terms of issue of the shares of that class) may, subject to the provisions of section 48 and whether or not the company is being wound up, be varied with the consent in writing of the holders of three-fourths of the issued shares of that class, or with the sanction of a special resolution passed at a separate meeting of the holders of the shares of that class.

(ii) To every such separate meeting, the provisions of these regulations relating to general meetings shall mutatis mutandis apply, but so that the necessary quorum shall be at least two persons holding at least one-third of the issued shares of the class in question.
10. The rights conferred upon the holders of the shares of any class issued with preferred or other rights shall not, unless otherwise expressly provided by the terms of issue of the shares of that class, be deemed to be varied by the creation or issue of further shares ranking pari passu therewith.
11. Subject to the provisions of section 55, any preference shares may, with the sanction of an ordinary resolution, be issued on the terms that they are to be redeemed on such terms and in such manner as the company before the issue of the shares may, by special resolution, determine.

Lien

12. (i) The Company shall have a first and paramount lien—
 - (a) on every share (not being a fully paid share), for all monies (whether presently payable or not) called, or payable at a fixed time, in respect of that share; and



(b) on all shares (not being fully paid shares) standing registered in the name of a single person, for all monies presently payable by him or his estate to the company:

Provided that the Board of directors may at any time declare any share to be wholly or in part exempt from the provisions of this clause.

- (ii) The company's lien, if any, on a share shall extend to all dividends payable and bonuses declared from time to time in respect of such shares.
- (iii) The fully paid shares shall be free from all lien and that in the case of partly paid shares the Company's lien shall be restricted to monies called or payable at a fixed time in respect of such shares.

13. The company may sell, in such manner as the Board thinks fit, any shares on which the company has a lien:

Provided that no sale shall be made—

- (a) unless a sum in respect of which the lien exists is presently payable; or
 - (b) until the expiration of fourteen days after a notice in writing stating and demanding payment of such part of the amount in respect of which the lien exists as is presently payable, has been given to the registered holder for the time being of the share or the person entitled thereto by reason of his death or insolvency.
14. (i) To give effect to any such sale, the Board may authorise some person to transfer the shares sold to the purchaser thereof.
- (ii) The purchaser shall be registered as the holder of the shares comprised in any such transfer.
- (iii) The purchaser shall not be bound to see to the application of the purchase money, nor shall his title to the shares be affected by any irregularity or invalidity in the proceedings in reference to the sale.
15. (i) The proceeds of the sale shall be received by the company and applied in payment of such part of the amount in respect of which the lien exists as is presently payable.
- (ii) The residue, if any, shall, subject to a like lien for sums not presently payable as existed upon the shares before the sale, be paid to the person entitled to the shares at the date of the sale.

Calls on shares

16. (i) The Board may, from time to time, make calls upon the members in respect of any monies unpaid on their shares (whether on account of the nominal value of the shares or by way of premium) and not by the conditions of allotment thereof made payable at fixed times:

Provided that no call shall exceed one-fourth of the nominal value of the share or be payable at less than one month from the date fixed for the payment of the last preceding call.

(ii) Each member shall, subject to receiving at least fourteen days' notice specifying the time or times and place of payment, pay to the company, at the time or times and place so specified, the amount called on his shares.

(iii) A call may be revoked or postponed at the discretion of the Board.

(iv) The option or right to make call on shares shall not be given to any person except with the sanction of the Company in General Meetings. That is, it may delegate power to make calls on shares subject to approval of the shareholders in a general meeting of the company.



17. A call shall be deemed to have been made at the time when the resolution of the Board authorizing the call was passed and may be required to be paid by installments.
18. The joint holders of a share shall be jointly and severally liable to pay all calls in respect thereof.
19. (i) If a sum called in respect of a share is not paid before or on the day appointed for payment thereof, the person from whom the sum is due shall pay interest thereon from the day appointed for payment thereof to the time of actual payment at ten per cent. Per annum or at such lower rate, if any, as the Board may determine.
(ii) The Board shall be at liberty to waive payment of any such interest wholly or in part.
20. (i) Any sum which by the terms of issue of a share becomes payable on allotment or at any fixed date, whether on account of the nominal value of the share or by way of premium, shall, for the purposes of these regulations, be deemed to be a call duly made and payable on the date on which by the terms of issue such sum becomes payable.
(ii) In case of non-payment of such sum, all the relevant provisions of these regulations as to payment of interest and expenses, forfeiture or otherwise shall apply as if such sum had become payable by virtue of a call duly made and notified.
21. The Board—
 - (a) may, if it thinks fit, receive from any member willing to advance the same, all or any part of the monies uncalled and unpaid upon any shares held by him; and
 - (b) upon all or any of the monies so advanced, may (until the same would, but for such advance, become presently payable) pay interest at such rate not exceeding, unless the company in general meeting shall otherwise direct, twelve per cent. per annum, as may be agreed upon between the Board and the member paying the sum in advance but shall not confer a right to dividend or to participate in profits.

Transfer of shares

22. (i) The Company shall use a Common form of transfer. The instrument of transfer of any share in the company shall be executed by or on behalf of both the transferor and transferee.
(ii) The transferor shall be deemed to remain a holder of the share until the name of the transferee is entered in the register of members in respect thereof.
23. The Board may, subject to the right of appeal conferred by section 58 decline to register—
 - (a) the transfer of a share, not being a fully paid share, to a person of whom they do not approve; or
 - (b) any transfer of shares on which the company has a lien.
24. The Board may decline to recognise any instrument of transfer unless—
 - (a) the instrument of transfer is in the form as prescribed in rules made under sub-section (1) of section 56;
 - (b) the instrument of transfer is accompanied by the certificate of the shares to which it relates, and such other evidence as the Board may reasonably require to show the right of the transferor to make the transfer; and
 - (c) the instrument of transfer is in respect of only one class of shares.



25. On giving not less than seven days' previous notice in accordance with section 91 and rules made thereunder, the registration of transfers may be suspended at such times and for such periods as the Board may from time to time determine:

Provided that such registration shall not be suspended for more than thirty days at any one time or for more than forty-five days in the aggregate in any year.

26. Subject to the provisions of Section 59 of Companies Act, 2013, the Board may decline to register any transfer of Shares on such grounds as it think fit in the benefit of the company (notwithstanding that the proposed transferee be already a Member), but in such case it shall, within two (2) months from the date the instrument of transfer was lodged with the Company, send to the transferee and the transferor notice of the refusal to register such transfer giving reasons for such refusal. Provided that registration of a transfer shall not be refused on the ground of the transferor being either alone or jointly with any other person or persons indebted to the Company on any account whatsoever.

Transmission of Shares

27. (i) On the death of a member, the survivor or survivors where the member was a joint holder, and his nominee or nominees or legal representatives where he was a sole holder, shall be the only persons recognised by the company as having any title to his interest in the shares.

(ii) Nothing in clause (i) shall release the estate of a deceased joint holder from any liability in respect of any share which had been jointly held by him with other persons.

28. (i) Any person becoming entitled to a share in consequence of the death or insolvency of a member may, upon such evidence being produced as may from time to time properly be required by the Board and subject as hereinafter provided, elect, either—

(a) to be registered himself as holder of the share; or

(b) to make such transfer of the share as the deceased or insolvent member could have made.

(ii) The Board shall, in either case, have the same right to decline or suspend registration as it would have had, if the deceased or insolvent member had transferred the share before his death or insolvency.

29. (i) If the person so becoming entitled shall elect to be registered as holder of the share himself, he shall deliver or send to the company a notice in writing signed by him stating that he so elects.

(ii) If the person aforesaid shall elect to transfer the share, he shall testify his election by executing a transfer of the share.

(iii) All the limitations, restrictions and provisions of these regulations relating to the right to transfer and the registration of transfers of shares shall be applicable to any such notice or transfer as aforesaid as if the death or insolvency of the member had not occurred and the notice or transfer were a transfer signed by that member.

30. A person becoming entitled to a share by reason of the death or insolvency of the holder shall be entitled to the same dividends and other advantages to which he would be entitled if he were the registered holder of the share, except that he shall not, before being registered as a member in respect of the share, be entitled in respect of it to exercise any right conferred by membership in relation to meetings of the company:

Provided that the Board may, at any time, give notice requiring any such person to elect either to be registered himself or to transfer the share, and if the notice is not complied with within ninety days, the Board may thereafter withhold payment of all dividends, bonuses or other monies payable in respect of the share, until the requirements of the notice have been complied with.



Forfeiture of Shares

31. If a member fails to pay any call, or installment of a call, on the day appointed for payment thereof, the Board may, at any time thereafter during such time as any part of the call or installment remains unpaid, serve a notice on him requiring payment of so much of the call or installment as is unpaid, together with any interest which may have accrued.
32. The notice aforesaid shall—
 - (a) name a further day (not being earlier than the expiry of fourteen days from the date of service of the notice) on or before which the payment required by the notice is to be made; and
 - (b) State that, in the event of non-payment on or before the day so named, the shares in respect of which the call was made shall be liable to be forfeited.
33. If the requirements of any such notice as aforesaid are not complied with, any share in respect of which the notice has been given may, at any time thereafter, before the payment required by the notice has been made, be forfeited by a resolution of the Board to that effect.
34. (i) A forfeited share may be sold or otherwise disposed of on such terms and in such manner as the Board thinks fit.
 - (ii) At any time before a sale or disposal as aforesaid, the Board may cancel the forfeiture on such terms as it thinks fit.
35. (i) A person whose shares have been forfeited shall cease to be a member in respect of the forfeited shares, but shall, notwithstanding the forfeiture, remain liable to pay to the company all monies which, at the date of forfeiture, were presently payable by him to the company in respect of the shares.
 - (ii) The liability of such person shall cease if and when the company shall have received payment in full of all such monies in respect of the shares.
36. (i) A duly verified declaration in writing that the declarant is a director, the manager or the secretary, of the company, and that a share in the company has been duly forfeited on a date stated in the declaration, shall be conclusive evidence of the facts therein stated as against all persons claiming to be entitled to the share.
 - (ii) The company may receive the consideration, if any, given for the share on any sale or disposal thereof and may execute a transfer of the share in favour of the person to whom the share is sold or disposed of.
 - (iii) The transferee shall thereupon be registered as the holder of the share
 - (iv) The transferee shall not be bound to see to the application of the purchase money, if any, nor shall his title to the share be affected by any irregularity or invalidity in the proceedings in reference to the forfeiture, sale or disposal of the share.
37. The provisions of these regulations as to forfeiture shall apply in the case of nonpayment of any sum which, by the terms of issue of a share, becomes payable at a fixed time, whether on account of the nominal value of the share or by way of premium, as if the same had been payable by virtue of a call duly made and notified.



Alteration of Capital

38. The company may, from time to time, by ordinary resolution increase the share capital by such sum, to be divided into shares of such amount, as may be specified in the resolution. The Authorised Share Capital shall be as per the clause V (a) of Memorandum of Association of the company.
39. Subject to the provisions of section 61, the company may, by ordinary resolution,—
- (a) increase its authorised share capital by such amount as it thinks expedient.
 - (b) consolidate and divide all or any of its share capital into shares of larger amount than its existing shares;
 - (c) convert all or any of its fully paid-up shares into stock, and reconvert that stock into fully paid-up shares of any denomination;
 - (d) sub-divide its existing shares or any of them into shares of smaller amount than is fixed by the memorandum;
 - (e) cancel any shares which, at the date of the passing of the resolution, have not been taken or agreed to be taken by any person.
40. Where shares are converted into stock,—
- (a) the holders of stock may transfer the same or any part thereof in the same manner as, and subject to the same regulations under which, the shares from which the stock arose might before the conversion have been transferred, or as near thereto as circumstances admit:
- Provided that the Board may, from time to time, fix the minimum amount of stock transferable, so, however, that such minimum shall not exceed the nominal amount of the shares from which the stock arose.
- (b) the holders of stock shall, according to the amount of stock held by them, have the same rights, privileges and advantages as regards dividends, voting at meetings of the company, and other matters, as if they held the shares from which the stock arose; but no such privilege or advantage (except participation in the dividends and profits of the company and in the assets on winding up) shall be conferred by an amount of stock which would not, if existing in shares, have conferred that privilege or advantage.
 - (c) such of the regulations of the company as are applicable to paid-up shares shall apply to stock and the words “share” and “shareholder” in those regulations shall include “stock” and “stock-holder” respectively.
41. The company may, by special resolution, reduce in any manner and with, and subject to, any incident authorised and consent required by law,—
- (a) its share capital;
 - (b) any capital redemption reserve account; or
 - (c) any share premium account.

Capitalisation of profits

42. (i) The company in general meeting may, upon the recommendation of the Board resolve—
- (a) that it is desirable to capitalise any part of the amount for the time being standing to the credit of any of the company’s reserve accounts, or to the credit of the profit and loss account, Securities Premium Accounts or otherwise available for distribution; and



- (b) that such sum be accordingly set free for distribution in the manner specified in clause (ii) amongst the members who would have been entitled thereto, if distributed by way of dividend and in the same proportions.
- (ii) The sum aforesaid shall not be paid in cash but shall be applied, subject to the provision contained in clause (iii), either in or towards—
- A. paying up any amounts for the time being unpaid on any shares held by such members respectively;
- B. paying up in full, unissued shares of the company to be allotted and distributed, credited as fully paid-up, to and amongst such members in the proportions aforesaid;
- C. partly in the way specified in sub-clause (A) and partly in that specified in sub-clause (B);
- (iii) A securities premium account and a capital redemption reserve account may, for the purposes of this regulation, be applied in the paying up of unissued shares to be issued to members of the company as fully paid bonus shares;
- (iv) The Board shall give effect to the resolution passed by the company in pursuance of this regulation.
43. (i) whenever such a resolution as aforesaid shall have been passed, the Board shall—
- a) make all appropriations and applications of the undivided profits resolved to be capitalised thereby, and all allotments and issues of fully paid shares if any; and
- b) Generally do all acts and things required to give effect thereto.
- (ii) The Board shall have power—
- a) to make such provisions, by the issue of fractional certificates or by payment in cash or otherwise as it thinks fit, for the case of shares becoming distributable in fractions; and
- b) to authorise any person to enter, on behalf of all the members entitled thereto, into an agreement with the company providing for the allotment to them respectively, credited as fully paid-up, of any further shares to which they may be entitled upon such capitalisation, or as the case may require, for the payment by the company on their behalf, by the application thereto of their respective proportions of profits resolved to be capitalised, of the amount or any part of the amounts remaining unpaid on their existing shares;
- (iii) Any agreement made under such authority shall be effective and binding on such members.

Dematerialisation of Securities

44. (i) **For the purpose of this Article:-**

"Beneficial Owner": Beneficial Owner shall have the meaning assigned thereto in section 2(1)(a) of the Depositories Act, 1996.

"Depositories Act": Depositories Act shall mean the Depositories Act, 1996 and includes any statutory modification or re-enactment thereof for the time being in force.

"Depository": Depository shall mean a Depository as defined in section 2(1)(e) of the Depositories Act, 1996.

"Member": Member shall mean a duly registered holder from time to time of the security of the company and includes every person whose name is entered as beneficial owner in the records of the Depository.



"Security": Security shall mean such security as may be specified by SEBI.

- (ii) **"Dematerialisation of Securities"**: Notwithstanding anything on the contrary contained in this Article, the company shall be entitled to dematerialise its securities and to offer securities in a dematerialised form and further to rematerialise the securities held on depository pursuant to the Depositories Act, 1996 or any amendment thereof.
- (iii) **"Option to hold securities in physical form or with depository"**: Every person holding securities of the company through allotment or otherwise shall have the option to receive and hold the same in the dematerialised form with a depository.
- (iv) **"Beneficial Owner may opt out of a Depository"**: Every person holding securities of the company with a depository, being the beneficial owner thereof, may at any time opt out of the depository in the manner provided under the provisions of the Depositories Act and the Rules, if any, prescribed there under and on fulfillment of the conditions prescribed by the company from time to time, company shall issue the relevant security certificates to the beneficial owner thereof.
- (v) **"Securities in Depositories to be in fungible form"**: All securities held by a depository shall be dematerialised and shall be in fungible form. Nothing contained in Sections 153, 153A, 153B, 187B, 187C and 372A of the Companies Act, shall apply to a depository in respect of the securities held by it on behalf of the beneficial owners.
- (vi) **"Rights of depository and beneficial owners"**: A depository shall be deemed to be the registered owner for the purposes of affecting the transfer of ownership of securities on behalf of the beneficial owners and shall not have any voting rights or any other rights in respect of the securities held by it.
- (vii) Every person holding securities of the Company and whose name is entered as the beneficial owner in the records of the depository shall be deemed to be a member of the Company. The beneficial owner of securities shall be entitled to all rights and benefits and be subject to all the liabilities in respect of his/her securities, which are held by a depository.
- (viii) **"Transfer of securities"**: Transfer of security held in a depository will be governed by the provisions of the Depository Act, 1996. Nothing contained in Section 56 of the Companies Act, 2013 or these Articles shall apply to a transfer of securities effected by a transferor and transferee both of whom are entered as beneficial owners in the records of a depository.
- (ix) **"Register and Index of beneficial owners"**: The Register and Index of beneficial owners maintained by a depository under the Depositories Act, 1996 shall be deemed to be the Register and Index of Members and Security holders for the purpose of these Articles.
- (x) **"Other matters"**: Notwithstanding anything contained in these Articles, the provision of Depositories Act, 1996 relating to dematerialisation of securities including any modification(s) or re-enactment thereof and Rules/Regulations made there under shall prevail accordingly.
- (xi) Notwithstanding anything contained in the Act or the Articles, where securities are held in a depository, the records of the beneficial ownership may be served by such depository on the company by means of electronic mode or by delivery of floppies or disks.

Nomination

45. Notwithstanding anything contained in Articles, every holder of shares(s) or debenture(s) of the Company may, at any time, nominate, in the prescribed manner, a person to whom these share(s) shall vest in the event



of his death and the provisions of Section 109A and Section 109B of the Companies Act, 1956 shall apply in respect of such nomination.

The provisions of this Article shall apply mutatis mutandis to a depository of money with the Company as per the provisions of the Act.

Buy-Back of Shares

46. Notwithstanding anything contained in these articles but subject to the provisions of sections 68 to 70 and any other applicable provision of the Act or any other law for the time being in force, the company may purchase its own shares or other specified securities.

General Meetings

47. All general meetings other than Annual General Meeting shall be called extraordinary general meeting.
48. (i) The Board may, whenever it thinks fit, call an extraordinary general meeting.
- (ii) If at any time directors capable of acting who are sufficient in number to form a quorum are not within India, any director or any two members of the company may call an extraordinary general meeting in the same manner, as nearly as possible, as that in which such a meeting may be called by the Board.

Proceedings at General Meetings

49. (i) No business shall be transacted at any general meeting unless a quorum of members is present at the time when the meeting proceeds to business.
- (ii) Save as otherwise provided herein, the quorum for the general meetings shall be as provided in section 103.
- (iii) The chairperson, if any, of the Board shall preside as Chairperson at every general meeting of the company.
- (iv) If there is no such Chairperson, or if he is not present within fifteen minutes after the time appointed for holding the meeting, or is unwilling to act as chairperson of the meeting, the directors present shall elect one of their members to be Chairperson of the meeting.
- (v) If at any meeting no director is willing to act as Chairperson or if no director is present within fifteen minutes after the time appointed for holding the meeting, the members present shall choose one of their members to be Chairperson of the meeting.

Adjournment of Meeting

50. (i) The Chairperson may, with the consent of any meeting at which a quorum is present, and shall, if so directed by the meeting, adjourn the meeting from time to time and from place to place.
- (ii) No business shall be transacted at any adjourned meeting other than the business left unfinished at the meeting from which the adjournment took place.
- (iii) When a meeting is adjourned for thirty days or more, notice of the adjourned meeting shall be given as in the case of an original meeting.
- (iv) Save as aforesaid, and as provided in section 103 of the Act, it shall not be necessary to give any notice of an adjournment or of the business to be transacted at an adjourned meeting.



Voting Rights

51. Subject to any rights or restrictions for the time being attached to any class or classes of shares,—
 - (a) on a show of hands, every member present in person shall have one vote; and
 - (b) on a poll, the voting rights of members shall be in proportion to his share in the paid-up equity share capital of the company.
52. A member may exercise his vote at a meeting by electronic means in accordance with section 108 and shall vote only once.
53. (i) In the case of joint holders, the vote of the senior who tenders a vote, whether in person or by proxy, shall be accepted to the exclusion of the votes of the other joint holders.

(ii) For this purpose, seniority shall be determined by the order in which the names stand in the register of members.
54. A member of unsound mind, or in respect of whom an order has been made by any court having jurisdiction in lunacy, may vote, whether on a show of hands or on a poll, by his committee or other legal guardian, and any such committee or guardian may, on a poll, vote by proxy.
55. Any business other than that upon which a poll has been demanded may be proceeded with, pending the taking of the poll.
56. No member shall be entitled to vote at any general meeting unless all calls or other sums presently payable by him in respect of shares in the company have been paid.
57. (i) No objection shall be raised to the qualification of any voter except at the meeting or adjourned meeting at which the vote objected to is given or tendered, and every vote not disallowed at such meeting shall be valid for all purposes.

(ii) Any such objection made in due time shall be referred to the Chairperson of the meeting, whose decision shall be final and conclusive.

Proxy

58. The instrument appointing a proxy and the power-of-attorney or other authority, if any, under which it is signed or a notarised copy of that power or authority, shall be deposited at the registered office of the company not less than 48 hours before the time for holding the meeting or adjourned meeting at which the person named in the instrument proposes to vote, or, in the case of a poll, not less than 24 hours before the time appointed for the taking of the poll; and in default the instrument of proxy shall not be treated as valid.
59. An instrument appointing a proxy shall be in the form as prescribed in the rules made under section 105.
60. A vote given in accordance with the terms of an instrument of proxy shall be valid, notwithstanding the previous death or insanity of the principal or the revocation of the proxy or of the authority under which the proxy was executed, or the transfer of the shares in respect of which the proxy is given:

Provided that no intimation in writing of such death, insanity, revocation or transfer shall have been received by the company at its office before the commencement of the meeting or adjourned meeting at which the proxy is used.



Board of Directors

61. The minimum number of Directors shall be 2 and maximum number of directors shall be 15.

The First Directors of the Company are:

- (a) Mr. Ashwinkumar Tendulkar
- (b) Mrs. Usha Tendulkar

62. (i) Subject to the provisions of the Act, the Company may pay any remuneration, as determined by the Board of Directors / General Meeting to all or any of its Directors for the services rendered by them / him in day to day management of the affairs of the company or any other type of services, whether professional in nature or not, for any of the purposes of the company, either by a fixed sum on monthly or annual basis and / or perquisites and / or a percentage of the profits or otherwise as may be determined by the Board or the members in General Meeting.

The remuneration of the directors shall, in so far as it consists of a monthly payment, be deemed to accrue from day-to-day.

(ii) In addition to the remuneration payable to them in pursuance of the Act, the directors may be paid all travelling, hotel and other expenses properly incurred by them—

- (a) in attending and returning from meetings of the Board of Directors or any committee thereof or general meetings of the company; or
- (b) in connection with the business of the company.

63. The Board may pay all expenses incurred in getting up and registering the company.

64. The company may exercise the powers conferred on it by section 88 with regard to the keeping of a foreign register; and the Board may (subject to the provisions of that section) make and vary such regulations as it may think fit respecting the keeping of any such register.

65. All cheques, promissory notes, drafts, hundis, bills of exchange and other negotiable instruments, and all receipts for monies paid to the company, shall be signed, drawn, accepted, endorsed, or otherwise executed, as the case may be, by such person and in such manner as the Board shall from time to time by resolution determine.

66. Every director present at any meeting of the Board or of a committee thereof shall sign his name in a book to be kept for that purpose.

67. (i) Subject to the provisions of section 149, the Board shall have power at any time, and from time to time, to appoint a person as an additional director, provided the number of the directors and additional directors together shall not at any time exceed the maximum strength fixed for the Board by the articles.

(ii) Such person shall hold office only up to the date of the next annual general meeting of the company but shall be eligible for appointment by the company as a director at that meeting subject to the provisions of the Act.

Proceedings of the Board

68. (i) The Board of Directors may meet for the conduct of business, adjourn and otherwise regulate its meetings, as it thinks fit.



- (ii) Subject to the Articles herein, a director may, and the manager or secretary on the requisition of a director shall, at any time, summon a meeting of the Board.
- (iii) Save as otherwise expressly provided in the Act, questions arising at any meeting of the Board shall be decided by a majority of votes.
- (iv) In case of an equality of votes, the Chairperson of the Board, if any, shall have a second or casting vote.
69. The continuing directors may act notwithstanding any vacancy in the Board; but, if and so long as their number is reduced below the quorum fixed by the Act for a meeting of the Board, the continuing directors or director may act for the purpose of increasing the number of directors to that fixed for the quorum, or of summoning a general meeting of the company, but for no other purpose.
70. (i) The Board may elect a Chairperson of its meetings and determine the period for which he is to hold office.
- (ii) If no such Chairperson is elected, or if at any meeting the Chairperson is not present within five minutes after the time appointed for holding the meeting, the directors present may choose one of their number to be Chairperson of the meeting.
71. (i) The Board may, subject to the provisions of the Act, delegate any of its powers to committees consisting of such member or members of its body as it thinks fit.
72. (i) Any committee so formed shall, in the exercise of the powers so delegated, conform to any regulations that may be imposed on it by the Board.
73. A committee may elect a Chairperson of its meetings.
74. If no such Chairperson is elected, or if at any meeting the Chairperson is not present within five minutes after the time appointed for holding the meeting, the members present may choose one of their members to be Chairperson of the meeting.
75. (i) A committee may meet and adjourn as it thinks fit.
- (ii) Questions arising at any meeting of a committee shall be determined by a majority of votes of the members present, and in case of an equality of votes, the Chairperson shall have a second or casting vote.
76. All acts done in any meeting of the Board or of a committee thereof or by any person acting as a director, shall, notwithstanding that it may be afterwards discovered that there was some defect in the appointment of any one or more of such directors or of any person acting as aforesaid, or that they or any of them were disqualified, be as valid as if every such director or such person had been duly appointed and was qualified to be a director.
77. Save as otherwise expressly provided in the Act, a resolution in writing, signed by all the members of the Board or of a committee thereof, for the time being entitled to receive notice of a meeting of the Board or committee, shall be valid and effective as if it had been passed at a meeting of the Board or committee, duly convened and held.

Chief Executive Officer, Manager, Company Secretary or Chief Financial Officer

78. Subject to the provisions of the Act,—
- (i) A chief executive officer, manager, company secretary or chief financial officer may be appointed by the Board for such term, at such remuneration and upon such conditions as it may think fit; and any chief executive officer, manager, company secretary or chief financial officer so appointed may be removed by means of a resolution of the Board;



- (ii) A director may be appointed as chief executive officer, manager, company secretary or chief financial officer.
79. A provision of the Act or these regulations requiring or authorising a thing to be done by or to a director and chief executive officer, manager, company secretary or chief financial officer shall not be satisfied by its being done by or to the same person acting both as director and as, or in place of, chief executive officer, manager, company secretary or chief financial officer.

Managing Director

80. The business of the Company may be carried on by the Managing Director(s) who may be appointed by the Board of Directors / members in their General Meeting, from time to time who shall fix the terms, qualifications, remuneration, duties, authorities and powers. The Board may from time to time and subject to the provisions of the Act delegate to the Managing Director(s) such of their powers and duties and subject to such limitations and conditions as they may deem fit. The Board may from time to time, revoke, withdraw, alter or vary all or any of the powers conferred on him or dismiss him from office and appoint another in his place.
81. Subject to the provisions of section 179 and 180 of the Companies Act, 2013, the Managing Director of the Company, if any, shall be empowered to carry on the day to day business affairs of the Company. He shall have the general control, management and superintendence of the business of the Company with power to appoint and to dismiss employees and to enter into contracts on behalf of the Company in the ordinary course of business and to do and perform all other acts, deeds and things which in the ordinary course of business may be considered necessary/proper or in the interest of the Company.

The Seal

82. (i) The Board shall provide for the safe custody of the seal.
- (ii) The seal of the company shall not be affixed to any instrument except by the authority of a resolution of the Board or of a committee of the Board authorised by it in that behalf, and except in the presence of at least two directors and of the secretary or such other person as the Board may appoint for the purpose; and those two directors and the secretary or other person aforesaid shall sign every instrument to which the seal of the company is so affixed in their presence.

Dividends and Reserve

83. The company in general meeting may declare dividends, but no dividend shall exceed the amount recommended by the Board.
84. Subject to the provisions of section 123, the Board may from time to time pay to the members such interim dividends as appear to it to be justified by the profits of the company.
85. (i) The Board may, before recommending any dividend, set aside out of the profits of the company such sums as it thinks fit as a reserve or reserves which shall, at the discretion of the Board, be applicable for any purpose to which the profits of the company may be properly applied, including provision for meeting contingencies or for equalizing dividends; and pending such application, may, at the like discretion, either be employed in the business of the company or be invested in such investments (other than shares of the company) as the Board may, from time to time, think fit.
- (ii) The Board may also carry forward any profits which it may consider necessary not to divide, without setting them aside as a reserve.
86. (i) Subject to the rights of persons, if any, entitled to shares with special rights as to dividends, all dividends shall be declared and paid according to the amounts paid or credited as paid on the shares in respect whereof the



dividend is paid, but if and so long as nothing is paid upon any of the shares in the company, dividends may be declared and paid according to the amounts of the shares.

(ii) No amount paid or credited as paid on a share in advance of calls shall be treated for the purposes of this regulation as paid on the share.

(iii) All dividends shall be apportioned and paid proportionately to the amounts paid or credited as paid on the shares during any portion or portions of the period in respect of which the dividend is paid; but if any share is issued on terms providing that it shall rank for dividend as from a particular date such share shall rank for dividend accordingly.

87. The Board may deduct from any dividend payable to any member all sums of money, if any, presently payable by him to the company on account of calls or otherwise in relation to the shares of the company.

88. (i) Any dividend, interest or other monies payable in cash in respect of shares may be paid by cheque or warrant sent through the post directed to the registered address of the holder or, in the case of joint holders, to the registered address of that one of the joint holders who is first named on the register of members, or to such person and to such address as the holder or joint holders may in writing direct.

(ii) Every such cheque or warrant shall be made payable to the order of the person to whom it is sent

89. Any one of two or more joint holders of a share may give effective receipts for any dividends, bonuses or other monies payable in respect of such share.

90. Notice of any dividend that may have been declared shall be given to the persons entitled to share therein in the manner mentioned in the Act.

91. No dividend shall bear interest against the company.

92. No unclaimed Dividend shall be forfeited before the claim becomes barred by law, and unclaimed Dividends shall be dealt with in accordance with the applicable provisions of the Act

Accounts

93. (i) The Board shall from time to time determine whether and to what extent and at what times and places and under what conditions or regulations, the accounts and books of the company, or any of them, shall be open to the inspection of members not being directors.

(ii) No member (not being a director) shall have any right of inspecting any account or book or document of the company except as conferred by law or authorised by the Board or by the company in general meeting.

Winding Up

94. If the company shall be wound up, the liquidator may, with the sanction of a special resolution of the company and any other sanction required by the Act, divide amongst the members, in specie or kind, the whole or any part of the assets of the company, whether they shall consist of property of the same kind or not.

95. For the purpose aforesaid, the liquidator may set such value as he deems fair upon any property to be divided as aforesaid and may determine how such division shall be carried out as between the members or different classes of members.

96. The liquidator may, with the like sanction, vest the whole or any part of such assets in trustees upon such trusts for the benefit of the contributories if he considers necessary, but so that no member shall be compelled to accept any shares or other securities whereon there is any liability.



Indemnity

97. Every officer of the company shall be indemnified out of the assets of the company against any liability incurred by him in defending any proceedings, whether civil or criminal, in which judgment is given in his favour or in which he is acquitted or in which relief is granted to him by the court or the Tribunal.



SECTION XI – OTHER INFORMATION

MATERIAL CONTRACTS AND DOCUMENTS FOR INSPECTION

The copies of the following contracts which have been entered or are to be entered into by the Company (not being contracts entered into in the ordinary course of business carried on by the Company or contracts entered into more than two years before the date of this Prospectus) which are or may be deemed material have been attached to the copy of the Prospectus delivered to the RoC for registration. Copies of the abovementioned contracts and also the documents for inspection referred to hereunder, may be inspected at the Registered Office between 10 a.m. and 5 p.m. on all Working Days from Application/Issue Opening Date until the Application/Issue Closing Date.

A. Material Contracts

1. Memorandum of Understanding dated March 22, 2018 between our Company, the Selling Shareholder and the Lead Manager and addendum dated June 12, 2018.
2. Memorandum of Understanding dated December 28, 2017 between our Company, the Selling Shareholder and the Registrar to the Issue.
3. Escrow Agreement June 07, 2018 between our Company, the Lead Manager, Banker to the Issue and the Registrar to the Issue.
4. Market Making Agreement dated March 22, 2018 between our Company, the Lead Manager and the Market Maker and addendum dated June 12, 2018.
5. Underwriting Agreement dated March 22, 2018 between our Company, the Lead Manager, the Market Maker and the Selling Shareholder and addendum dated June 12, 2018.
6. Share Escrow Agreement dated June 07, 2018 between the Selling Shareholder, our Company, the Lead Manager and the Escrow Agent.
7. Tripartite agreement between the NSDL, our Company and the Registrar dated December 15, 2017.
8. Tripartite agreement between the CDSL, our Company and the Registrar dated November 29, 2017.

B. Material Documents

1. Certified true copies of the Memorandum and Articles of Association of our Company, as amended from time to time.
2. Copy of Certificates of Incorporation of Saketh Exim Private Limited.
3. Resolution of the Board of Directors meeting dated March 20, 2018 authorizing the Issue.
4. Shareholders' resolution passed at the Extra-Ordinary General Meeting dated March 22, 2018 authorizing the Issue.
5. Auditor's report for Restated Financials dated July 14, 2018 included in this Prospectus.
6. The Statement of Tax Benefits dated July 14, 2018 from our Statutory Auditor.



7. Consent of our Directors, CFO, CS, Selling Shareholder, Statutory Auditor / Peer Review Auditor, Lead Manager, Legal Advisor to the Issue, Registrar to the Issue, Share Escrow Agent, Banker to the Company, Banker to the Issue, Market Maker and Underwriters as referred to in their specific capacities.
8. Due Diligence Certificate(s) dated July 23, 2018 of the Lead Manager to be submitted to SEBI along with the filing of the Prospectus.
9. Approval from NSE vide letter dated May 18, 2018 to use the name of NSE in this Issue Document for listing of Equity Shares on the EMERGE Platform of the NSE.

Any of the contracts or documents mentioned in this Prospectus may be amended or modified at any time if so required in the interest of our Company or if required by the other parties, without reference to the shareholders subject to compliance of the provisions contained in the Companies Act and other relevant statutes.



DECLARATION

We, hereby declare that, all the relevant provisions of the Companies Act, 1956, Companies Act, 2013 (to the extent notified) and the guidelines issued by the Government of India or the regulations or guidelines issued by the Securities and Exchange Board of India, as the case may be, have been complied with and no statement made in the Prospectus is contrary to the provisions of the Companies Act, 1956, Companies Act, 2013 (to the extent notified), the Securities and Exchange Board of India Act, 1992, each as amended or rules made there under or guidelines / regulations issued, as the case may be. We further certify that all the disclosures and statements made in the Prospectus are true and correct.

SIGNED BY THE DIRECTORS OF OUR COMPANY:

Sd/-

Mr. Sanjay J Patel
Managing Director

Sd/-

Mrs. Smita S Patel
Chairman & Non Executive Non Independent Director

Sd/-

Mrs. Taruna P Patel
Non-Executive Non Independent Director

Sd/-

Mr. Jasbir Singh Anand
Independent Director

Sd/-

Mr. Jehan D Variava
Independent Director

SIGNED BY THE CHIEF FINANCIAL OFFICER:

Sd/-

Mr. Shabbir H Merchant
Chief Financial Officer

SIGNED BY THE COMPANY SECRETARY AND COMPLIANCE OFFICER:

Sd/-

Ms. Neelam Pathak
Company Secretary and Compliance Officer

Date: July 23, 2018

Place: Mumbai



DECLARATION

The undersigned Selling Shareholder hereby certifies that all statements and undertakings made in this Prospectus about or in relation to him and the Equity Shares being offered by him in the Issue are true and correct, provided however, that the undersigned Selling Shareholder assumed no responsibility for any of the Statements or undertakings made by the Company or any expert or any other person(s) in this Prospectus.

SIGNED BY THE SELLING SHAREHOLDER:

Sd/-

Mr. Piyush J Patel

Date: July 23, 2018

Place: Mumbai