



**KRISHANA PHOSCHEM LIMITED**  
Corporate Identity Number: - U24124RJ2004PLC019288

Our Company was originally incorporated on May 14, 2004 as “Krishana Phoschem Limited” vide Registration no. 17-019288/2004-2005 (CIN: U24124RJ2004PLC019288) under the provisions of the Companies Act, 1956 with the Registrar of Companies, Rajasthan, Jaipur. For details of the changes in our Registered Office, please see section titled “History and Certain Corporate Matters” on page 122 of this Prospectus.

**Registered Office:** 5-O-20 Basement R.C Vyas Colony Bhilwara, Rajasthan – 311001, India  
**Tel No:** +91-1482-237104/ 239091/ 230060; **E-mail:** [secretarial@krishnaphoschem.com](mailto:secretarial@krishnaphoschem.com); **Website:** [www.krishnaphoschem.com](http://www.krishnaphoschem.com)  
**Contact Person:** Ms. Priyanka Bansal (Company Secretary & Compliance Officer)

**PROMOTERS OF OUR COMPANY:** MR. PRAVEEN OSTWAL, OSTWAL PHOSCHEM (INDIA) LIMITED AND SEASONS AGRO CHEM INDIA PRIVATE LIMITED

**THE OFFER**

**INITIAL PUBLIC OFFER OF 65,76,000 EQUITY SHARES OF FACE VALUE OF ₹ 10.00 EACH OF KRISHANA PHOSCHEM LIMITED (“OUR COMPANY”) FOR CASH AT A PRICE OF ₹ 30.00 PER EQUITY SHARE (INCLUDING A SHARE PREMIUM OF ₹20.00 PER EQUITY SHARE) (“OFFER PRICE”) AGGREGATING TO ₹ 1972.80 LAKHS (“THE OFFER”) THROUGH AN OFFER FOR SALE BY MAHENDRA KUMAR OSTWAL, PANKAJ OSTWAL HUF, PRAVEEN OSTWAL HUF, CHUNRI PRINTS PVT. LTD., PANERI TEXTILES PVT. LTD, ARCHID PRODUCTS PVT. LTD, MRS. NITU OSTWAL, MRS. EKTA JAIN, MR. PANKAJ OSTWAL, MAHENDRA KUMAR OSTWAL HUF, SEASONS AGRO CHEM INDIA PVT. LIMITED, MADHYA BHARAT AGRO PRODUCTS LIMITED (COLLECTIVELY REFERRED AS PROMOTERS AND PROMOTER GROUP SELLING SHAREHOLDERS HEREIN AFTER), OF WHICH 3,36,000 EQUITY SHARES OF FACE VALUE OF ₹10.00 EACH FOR A CASH PRICE OF ₹30.00 PER EQUITY SHARE, AGGREGATING TO ₹100.80 LAKHS WILL BE RESERVED FOR SUBSCRIPTION BY MARKET MAKER (“MARKET MAKER RESERVATION PORTION”). THE OFFER LESS THE MARKET MAKER RESERVATION PORTION I.E. OFFER OF 62,40,000 EQUITY SHARES OF FACE VALUE OF ₹10.00 EACH AT AN OFFER PRICE OF ₹30.00 PER EQUITY SHARE AGGREGATING TO ₹1872.00 LAKHS (IS HEREINAFTER REFERRED TO AS THE “NET OFFER”). THE OFFER AND THE NET OFFER WILL CONSTITUTE 26.41% and 25.06%, RESPECTIVELY OF THE POST OFFER PAID UP EQUITY SHARE CAPITAL OF OUR COMPANY. FOR FURTHER DETAILS, PLEASE REFER TO SECTION TITLED “TERMS OF THE OFFER” BEGINNING ON PAGE 244 OF THIS PROSPECTUS.**

**THE FACE VALUE OF THE EQUITY SHARES IS ₹ 10.00 EACH AND THE OFFER PRICE IS ₹30.00 EACH. THE OFFER PRICE IS 3.00 TIMES OF THE FACE VALUE.**

**THIS OFFER IS BEING MADE IN TERMS OF CHAPTER XB OF THE SECURITIES AND EXCHANGE BOARD OF INDIA (ISSUE OF CAPITAL AND DISCLOSURE REQUIREMENTS) REGULATIONS, 2009 (THE “SEBI ICDR REGULATIONS”), AS AMENDED. THIS OFFER IS A FIXED PRICE OFFER AND ALLOCATION IN THE NET OFFER TO THE PUBLIC WILL BE MADE IN TERMS OF REGULATION 43(4) OF THE SEBI (ICDR) REGULATIONS, 2009, AS AMENDED. FOR FURTHER DETAILS, PLEASE REFER TO SECTION TITLED “OFFER PROCEDURE” BEGINNING ON PAGE 252 OF THIS PROSPECTUS.**

All the investors applying in a public offer shall use only Application Supported by Blocked Amount (ASBA) facility for making payment providing details about the bank account which will be blocked by the Self Certified Syndicate Banks (“SCSBs”) as per the SEBI circular CIR/CFD/POLICYCELL/11/2015 dated November 10, 2015. For further details, please refer to section titled “Offer Procedure” beginning on page 252 of this Prospectus.

**ELIGIBLE INVESTORS**

For details in relation to Eligible Investors, please refer to section titled “Offer Procedure” beginning on page 252 of this Prospectus.

**RISK IN RELATION TO THE FIRST OFFER**

This being the first public offer of the Equity Shares of our Company, there has been no formal market for the Equity Shares of our Company. The face value of the Equity Shares of the Company is ₹10.00 per equity share and the Offer Price is 3.00 times of the face value. The Offer Price (has been determined and justified by our Company in consultation with the Lead Manager as stated under the paragraph ‘Basis for Offer Price’ on page 74 of this Prospectus) should not be taken to be indicative of the market price of the Equity Shares after the Equity Shares are listed. No assurance can be given regarding an active and/or sustained trading in the Equity Shares of our Company or regarding the price at which the Equity Shares will be traded after listing.

**GENERAL RISKS**

Investments in equity and equity related securities involve a degree of risk and investors should not invest any funds in this Offer unless they can afford to take the risk of losing their investment. Investors are advised to read the “Risk Factors” carefully before taking an investment decision in this Offer. For taking an investment decision, investors must rely on their own examination of our Company and the Offer including the risks involved. The Equity Shares offered in the Offer have not been recommended or approved by the Securities and Exchange Board of India (“SEBI”), nor does SEBI guarantee the accuracy or adequacy of this Prospectus. **Specific attention of the investors is invited to the section titled ‘Risk Factors’ beginning on page 16 of this Prospectus.**

**COMPANY’S & SELLING SHAREHOLDERS’ ABSOLUTE RESPONSIBILITY**



Our Company & Selling Shareholders have made all reasonable inquiries, accepts responsibility for and confirms that this Prospectus contains all information with regard to our Company and this Offer, which is material in the context of this Offer, that the information contained in this Prospectus is true and correct in all material aspects and is not misleading in any material respect, that the opinions and intentions expressed herein are honestly held and that there are no other facts, the omission of which makes this Prospectus as a whole or any of such information or the expression of any such opinions or intentions misleading in any material respect. Further, the Selling Shareholder accepts responsibility that this Prospectus contains all information about itself as the Selling Shareholder in the context of the Offer for Sale and assumes responsibility for statements in relation to itself included in this Prospectus.

**LISTING**

The Equity Shares offered through this Prospectus are proposed to be listed on the SME Platform of National Stock Exchange of India Limited (“NSE” i.e. “NSE EMERGE”). In terms of the Chapter XB of the SEBI (ICDR) Regulations, 2009, as amended, we are not required to obtain an in-principle listing approval for the shares being offered in this Offer. However, our Company has received an approval letter dated January 25, 2017 from NSE for using its name in this offer document for listing of our shares on the SME Platform of NSE (“NSE EMERGE”). For the purpose of this Offer, the Designated Stock Exchange will be the National Stock Exchange of India Limited.

**LEAD MANAGER TO THE OFFER**

**REGISTRAR TO THE OFFER**

 <p><b>Hem Securities Ltd</b></p> <p><b>HEM SECURITIES LIMITED</b> 14/15 Khatau Building, 1st Floor, 40 Bank Street, Fort, Mumbai – 400001, Maharashtra <b>Tel. No.:</b> +91- 22-49060000 <b>Fax No.:</b> +91- 22-22625991 <b>Website:</b> <a href="http://www.hemsecurities.com">www.hemsecurities.com</a> <b>Email:</b> <a href="mailto:hb@hemsecurities.com">hb@hemsecurities.com</a> <b>Investor Grievance Email:</b> <a href="mailto:redressal@hemsecurities.com">redressal@hemsecurities.com</a> <b>Contact Person:</b> Mr. Anil Bhargava <b>SEBI Regn. No.</b> INM000010981</p>	 <p><b>LINK INTIME INDIA PRIVATE LIMITED</b> C-13, Pannalal Silk Mills Compound, L.B.S. Marg, Bhandup (West) Mumbai 400 078, Maharashtra, India <b>Tel. No.:</b> +91-22 – 61715400 <b>Fax No.:</b> +91-22 – 25960329 <b>Website:</b> <a href="http://www.linkintime.co.in">www.linkintime.co.in</a> <b>Email:</b> <a href="mailto:kpl.ipo@linkintime.co.in">kpl.ipo@linkintime.co.in</a> <b>Investor Grievance Email:</b> <a href="mailto:kpl.ipo@linkintime.co.in">kpl.ipo@linkintime.co.in</a> <b>Contact Person:</b> Ms. Shanti Gopalkrishnan <b>SEBI Regn. No.</b> INR000004058</p>
---	---

**OFFER PROGRAMME**

**OFFER OPENS ON: MONDAY, FEBRUARY 13, 2017**

**OFFER CLOSURES ON: THURSDAY, FEBRUARY 16, 2017**

## TABLE OF CONTENTS

SECTION	CONTENTS	PAGE NO.
<b>I</b>	<b>GENERAL</b>	
	DEFINITIONS AND ABBREVIATIONS	1
	CERTAIN CONVENTIONS, USE OF FINANCIAL INFORMATION AND MARKET DATA AND CURRENCY OF FINANCIAL PRESENTATION	13
	FORWARD LOOKING STATEMENTS	15
<b>II</b>	<b>RISK FACTORS</b>	16
<b>III</b>	<b>INTRODUCTION</b>	
	SUMMARY OF OUR INDUSTRY	35
	SUMMARY OF OUR BUSINESS	38
	SUMMARY OF OUR FINANCIALS	41
	THE OFFER	45
	GENERAL INFORMATION	46
	CAPITAL STRUCTURE	54
	OBJECTS OF THE OFFER	71
	BASIC TERMS OF OFFER	72
	BASIS FOR OFFER PRICE	74
	STATEMENT OF TAX BENEFITS	77
<b>IV</b>	<b>ABOUT THE COMPANY</b>	
	INDUSTRY OVERVIEW	79
	OUR BUSINESS	91
	REGULATIONS AND POLICIES	107
	HISTORY AND CERTAIN CORPORATE MATTERS	122
	OUR MANAGEMENT	127
	OUR PROMOTER AND PROMOTER GROUP	139
	OUR GROUP COMPANIES	148
	DIVIDEND POLICY	156
<b>V</b>	<b>FINANCIAL INFORMATION OF THE COMPANY</b>	
	RESTATED FINANCIAL STATEMENT	157
	STATEMENT OF FINANCIAL INDEBTEDNESS	190
	MANAGEMENT'S DISCUSSION AND ANALYSIS OF FINANCIAL CONDITIONS AND RESULTS OF OPERATIONS	192
<b>VI</b>	<b>LEGAL AND OTHER INFORMATION</b>	
	OUTSTANDING LITIGATIONS AND MATERIAL DEVELOPMENTS	205
	GOVERNMENT AND OTHER APPROVALS	222
	OTHER REGULATORY AND STATUTORY DISCLOSURES	230
<b>VII</b>	<b>OFFER RELATED INFORMATION</b>	
	TERMS OF THE OFFER	244
	OFFER STRUCTURE	250
	OFFER PROCEDURE	252
	RESTRICTIONS ON FOREIGN OWNERSHIP OF INDIAN SECURITIES	292
<b>VIII</b>	<b>MAIN PROVISIONS OF THE ARTICLES OF ASSOCIATION OF OUR COMPANY</b>	294
<b>IX</b>	<b>OTHER INFORMATION</b>	
	MATERIAL CONTRACTS AND DOCUMENTS FOR INSPECTION	322
	DECLARATION	323

## SECTION I – GENERAL

### DEFINITIONS AND ABBREVIATIONS

*This Prospectus uses certain definitions and abbreviations which, unless the context otherwise indicates or implies, shall have the meaning as provided below. References to any legislation, act, regulation, rule, guideline or policy shall be to such legislation, act, regulation, rule, guideline or policy, as amended, supplemented or re-enacted from time to time.*

*The words and expressions used in this Prospectus but not defined herein, shall have, to the extent applicable, the meaning ascribed to such terms under the Companies Act, the SEBI ICDR Regulations, the SCRA, the Depositories Act or the rules and regulations made there under.*

*Notwithstanding the foregoing, terms used in of the sections “Statement of Tax Benefits”, “Financial Information of the Company” and “Main Provisions of Articles of Association” on pages 77, 157 and 294, respectively, shall have the meaning ascribed to such terms in such sections.*

*Unless the context otherwise indicates, all references to “KPL”, “the Company”, “our Company”, “we”, “us” and “our” are references to Krishana Phoschem Limited, a company incorporated in India under the Companies Act 1956 having its Registered at 5-O-20 Basement R.C Vyas Colony Bhilwara, Rajasthan – 311001, India and “you”, “your” or “yours” refer to Prospective investors in this Offer.*

#### **Company Related Terms**

<b>Terms</b>	<b>Description</b>
AOA / Articles / Articles of Association	Articles of Association of Krishana Phoschem Limited, as amended from time to time.
Auditors/ Statutory Auditors	The Auditors of Krishana Phoschem Limited being M/s Ashok Kanther & Associates, Chartered Accountant.
Audit Committee	The Committee of the Board of Directors constituted as the Company’s Audit Committee in accordance with Section 177 of the Companies Act, 2013 and Regulation 18 of SEBI (Listing Obligations and Disclosures Requirement) Regulation, 2015
Bankers to the Company	HDFC Bank Limited
Board of Directors / the Board / our Board	The Board of Directors of Krishana Phoschem Limited, including all duly constituted Committees thereof.
CIN	Corporate Identification Number.
Chief financial Officer	The Chief financial Officer of our Company being Mr. Sunil Kothari
Companies Act / Act	The Companies Act, 2013 and amendments thereto. The Companies Act, 1956, to the extent of such of the provisions that are in force.
Company Secretary and Compliance Officer	The Company Secretary and Compliance Officer of our Company being Ms. Priyanka Bansal
Corporate Promoters	Ostwal Phoschem (India) Limited (formally known as Tedco Granite Limited) and Seasons Agro Chem India Private Limited.
CSR Committee	The corporate social responsibility committee of our Board constituted in accordance with the Companies Act, 2013.
Depositories Act	The Depositories Act, 1996, as amended from time to time.
Depositories	National Securities Depository Limited (NSDL) and Central Depository Services (India) Limited (CDSL).
DIN	Directors Identification Number.
Director(s) / our Directors	The Director(s) of our Company, unless otherwise specified.
Equity Shares	Equity Shares of the Company of Face Value of Rs.10/- each unless otherwise specified in the context thereof.
Equity Shareholders	Persons/ Entities holding Equity Shares of Our Company.
Executive Directors	Executive Directors are the Managing Director & Whole Time Directors of our Company.
Factories	Unit I - 115-120 & 126-133, AKVN Industrial Area, Meghnagar, Jhabua, Madhya Pradesh Unit II - 142 & 143, AKVN Industrial Area, Meghnagar, Jhabua, Madhya Pradesh Unit III - 126 A & 134, AKVN Industrial Area, Meghnagar, Jhabua, Madhya Pradesh

Terms	Description
Group Companies	The word “group companies”, wherever they occur, shall include such companies as covered under the applicable accounting standards and also other companies as considered material by the board of the company as disclosed in “Our Group Companies” promoted by the Promoters on page 148 of this Prospectus.
HUF	Hindu Undivided Family.
IBC	The Insolvency and Bankruptcy Code, 2016
IFRS	International Financial Reporting Standards
Independent Director	A non-executive, independent Director as per the Companies Act, 2013 and the Listing Regulations.
Indian GAAP	Generally Accepted Accounting Principles in India
ISIN	International Securities Identification Number. In this case being – INE506W01012
IT Act	The Income Tax Act, 1961 as amended till date
Key Management Personnel/ KMP	Key Management Personnel of our Company in terms of the SEBI Regulations and the Companies Act, 2013. For details, see section entitled “Our Management” on page 127 of this Prospectus.
Materiality Policy	The policy on identification of group companies, material creditors and material litigation, adopted by our Board on December 20, 2016 in accordance with the requirements of the SEBI (ICDR) Regulations.
MOA / Memorandum of Association	Memorandum of Association of Krishana Phoschem Limited as amended from time to time.
Non Residents	A person resident outside India, as defined under FEMA Regulations, 2000
Nomination and Remuneration Committee	The nomination and remuneration committee of our Board constituted in accordance with the Companies Act, 2013 and the Listing Regulations.
Non-Executive Director	A Director not being an Executive Director or an Independent Director
NRIs / Non-Resident Indians	A person resident outside India, as defined under FEMA Regulation and who is a citizen of India or a Person of Indian Origin under Foreign Exchange Management (Transfer or Issue of Security by a Person Resident Outside India) Regulations, 2000.
Offered Shares	Collectively, the Shares offered by Promoters and Promoter Group
Ostwal Group of Industries	A Group of Industries including companies as disclosed under section titled “Our Group Companies” beginning on page 148 of this Prospectus.
Peer Review Auditor	Independent Auditor having a valid Peer Review certificate in our case being M/s. Mansaka Ravi & Associates, Chartered Accountant.
Person or Persons	Any individual, sole proprietorship, unincorporated association, unincorporated organization, body corporate, corporation, company, partnership, limited liability company, joint venture, or trust or any other entity or organization validly constituted and/or incorporated in the jurisdiction in which it exists and operates, as the context requires.
Promoters	Shall mean promoters of our Company i.e. Mr. Praveen Ostwal, Ostwal Phoschem (India) Limited and Seasons Agro Chem India Private Limited
Promoter Group	Includes such Persons and entities constituting our promoter group covered under Regulation 2(1)(zb) of the SEBI (ICDR) Regulations as enlisted in the section titled “Our Promoters and Promoters Group” beginning on page 139 of this Prospectus.
RBI Act	The Reserve Bank of India Act, 1934 as amended from time to time.
Registered Office of our Company	5-O-20 Basement R.C Vyas Colony Bhilwara, Rajasthan – 311001, India
Reserve Bank of India / RBI	Reserve Bank of India constituted under the RBI Act.
Restated Financial Information	The restated audited financial information of the Company, which comprises of the restated audited balance sheet, the restated audited profit and loss information and restated audited cash flow information, as at and for years ended March 31, 2012, 2013, 2014, 2015 and 2016 and period ended November 30, 2016 together with the annexure and notes thereto as disclosed in chapter titled “Financial Information of the Company” beginning on Page 157 of this Prospectus.
RoC/Registrar of Companies	Registrar of Companies, Rajasthan, Jaipur
SEBI	Securities and Exchange Board of India constituted under the SEBI Act, 1992.
SEBI Act	Securities and Exchange Board of India Act, 1992, as amended from time to time.

Terms	Description
SEBI (ICDR) Regulations /ICDR Regulation/ Regulation	SEBI (Issue of Capital and Disclosure Requirements) Regulations, 2009 issued by SEBI on August 26, 2009, as amended, including instructions and clarifications issued by SEBI from time to time.
SEBI Takeover Regulations or SEBI (SAST) Regulations	Securities and Exchange Board of India (Substantial Acquisition of Shares and Takeover) Regulations, 2011, as amended from time to time.
SEBI (Venture Capital) Regulations	Securities Exchange Board of India (Venture Capital) Regulations, 1996 as amended from time to time.
SEBI Insider Trading Regulations	The Securities and Exchange Board of India (Prohibition of Insider Trading) Regulations, 2015 as amended, including instructions and clarifications issued by SEBI from time to time.
SEBI Listing Regulations, 2015/ SEBI Listing Regulations/Listing Regulations/SEBI (LODR)	The Securities and Exchange Board of India (Listing Obligation and Disclosure Requirements) Regulations, 2015 as amended, including instructions and clarifications issued by SEBI from time to time.
Selling Shareholders	Mr. Mahendra Kumar Ostwal, Pankaj Ostwal HUF, Praveen Ostwal HUF, Chunri Prints Pvt. Ltd, Paneri Textiles Pvt. Ltd, Archid Products Pvt. Ltd, Mrs. Nitu Ostwal, Mrs. Ekta Jain, Mr. Pankaj Ostwal, Mahendra Kumar Ostwal HUF, Seasons Agro Chem India Pvt. Ltd. and Madhya Bharat Agro Products Limited.
Sub- Account	Sub- accounts registered with SEBI under the Securities and Exchange Board of India (Foreign Institutional Investor) Regulations, 1995, other than sub-accounts which are foreign corporate or foreign individuals.
Subscriber to MOA	Initial Subscriber to MOA & AOA being Mr. Roop Lal Patel, Mrs. Leela Patel, Mr. Jitendra Patel, Mr. Vinod paliwal, Mrs. Geeta Paliwal, Mr. Narendra paliwal and Mr. Dilip Kumar Gadia
Stock Exchange Stakeholders' Relationship Committee	Unless the context requires otherwise, refers to, National Stock Exchange of India Limited Stakeholder's relationship committee of our Company constituted in accordance with Regulation 20 of the SEBI (LODR) Regulations and Companies Act, 2013.
Unit I	Located at 115-120 & 126-133, AKVN Industrial Area, Meghnagar, Jhabua, Madhya Pradesh
Unit II	Located at 142 & 143, AKVN Industrial Area, Meghnagar, Jhabua, Madhya Pradesh
Unit III	Located at 126A & 134, AKVN Industrial Area, Meghnagar, Jhabua, Madhya Pradesh

## **OFFER RELATED TERMS**

Terms	Description
Allotment/Allot/Allotted	Unless the context otherwise requires, means the allotment of Equity Shares pursuant to the offer for sale by each of the Selling Shareholders.
Acknowledgement Slip	The slip or document issued by the Designated Intermediary to an applicant as proof of registration of the Application.
Allotment Advice	Note or advice or intimation of Allotment sent to the Applicants who have been allotted Equity Shares after the Basis of Allotment has been approved by the Designated Stock Exchanges.
Allottee (s)	A successful applicant to whom the Equity Shares are allotted
Applicant/Investor	Any Prospective Investor who makes an application pursuant to the terms of the Prospectus and the Application Form.
Application Amount	The amount at which the Applicant makes an application for the Equity Shares of our Company in terms of Prospectus.
Application Form	The form, whether physical or electronic, used by an Applicant to make an application, which will be considered as the application for Allotment for purposes of this Prospectus.
ASBA Account	Account maintained by the ASBA Investor with an SCSB which will be blocked by such SCSB to the extent of the Application Amount of the ASBA Investor.
ASBA Application Location (s)/ Specified Cities	Cities as specified in the SEBI Circular No. CIR/CFD/DIL/1/2011 dated April 29, 2011, namely, Ahmedabad, Bangalore, Baroda (Vadodara), Chennai, Delhi, Hyderabad, Jaipur, Kolkata, Mumbai, Pune, Rajkot and Surat
Bankers to the Company	HDFC Bank Limited

Terms	Description
Bankers to the Offer	Banks which are clearing members and registered with SEBI as Bankers to an Offer and with whom the Public Offer Account will be opened, in this case being HDFC Bank Limited
Banker to the Offer Agreement	Agreement dated January 31, 2017 entered into amongst the Company, Selling Shareholders, Lead Manager, the Registrar and the Banker of the Offer.
Basis of Allotment	The basis on which the Equity Shares will be Allotted to successful applicants under the Offer and which is described in the chapter titled “Offer Procedure” beginning on page 252 of this Prospectus.
Broker Centres	Broker centers notified by the Stock Exchanges where investors can submit the Application Forms to a Registered Broker. The details of such Broker Centers, along with the names and contact details of the Registered Brokers are available on the websites of the Stock Exchange.
BSE	BSE Limited
Business Day	Monday to Friday (except public holidays)
CAN or Confirmation of Allocation Note	The Note or advice or intimation sent to each successful Applicant indicating the Equity which will be allotted, after approval of Basis of Allotment by the designated Stock Exchange.
Client Id	Client Identification Number maintained with one of the Depositories in relation to demat account
Collecting Depository Participants or CDPs	A depository participant as defined under the Depositories Act, 1996, registered with SEBI and who is eligible to procure Applications at the Designated CDP Locations in terms of circular no. CIR/CFD/POLICYCELL/11/2015 dated November 10, 2015 issued by SEBI
Controlling Branches of the SCSBs	Such branches of the SCSBs which coordinate with the LM, the Registrar to the Offer and the Stock Exchange.
Demographic Details	The demographic details of the applicants such as their Address, PAN, name of the applicants father/husband, investor status, and Occupation and Bank Account details.
Depository / Depositories	A depository registered with SEBI under the Securities and Exchange Board of India (Depositories and Participants) Regulations, 1996 as amended from time to time, being NSDL and CDSL.
Designated Date	On the Designated Date, the amounts blocked by SCSBs are transferred from the ASBA Accounts to the Public Offer Account and/ or unblocked in terms of the Prospectus.
Designated SCSB Branches	Such branches of the SCSBs which shall collect the ASBA Application Form from the Applicant and a list of which is available on the website of SEBI at <a href="http://www.sebi.gov.in/sebiweb/home/list/5/33/0/0/">http://www.sebi.gov.in/sebiweb/home/list/5/33/0/0/</a> . Recognized-Intermediaries or at such other website as may be prescribed by SEBI from time to time
Designated CDP Locations	Such locations of the CDPs where Applicant can submit the Application Forms to Collecting Depository Participants.  The details of such Designated CDP Locations, along with names and contact details of the Collecting Depository Participants eligible to accept Application Forms are available on the website of the Stock Exchange i.e. <a href="http://www.nseindia.com">www.nseindia.com</a>
Designated RTA Locations	Such locations of the RTAs where Applicant can submit the Application Forms to RTAs. The details of such Designated RTA Locations, along with names and contact details of the RTAs eligible to accept Application Forms are available on the websites of the Stock Exchange i.e. <a href="http://www.nseindia.com">www.nseindia.com</a>
Designated Date	On the Designated Date, the SCSBs shall transfer the funds represented by allocation of Equity Shares into the Public Offer Account with the Bankers to the Offer.
Designated Intermediaries/Collecting Agent	An SCSB’s with whom the bank account to be blocked, is maintained, a syndicate member (or sub-syndicate member), a Stock Broker registered with recognized Stock Exchange, a Depository Participant, a registrar to an Offer and share transfer agent (RTA) (whose names is mentioned on website of the stock exchange as eligible for this activity)
Designated Market Maker	Hem Finlease Private Limited
Designated Stock Exchange	National Stock Exchange of India Limited (SME Exchange) (“NSE EMERGE”)
DP	Depository Participant
DP ID	Depository Participant’s Identity number.
Draft Prospectus	Draft Prospectus dated December 29, 2016 issued in accordance with Section 32 of the

Terms	Description
	Companies Act, 2013.
Eligible NRI	A Non Resident Indian in a jurisdiction outside India where it is not unlawful to make an offer or invitation under the Offer and in relation to whom this Prospectus will constitute an invitation to subscribe for the Equity Shares.
Equity Shares	Equity Shares of our Company of face value ₹ 10.00 each
Electronic Transfer of Funds	Refunds through ECS, NEFT, Direct Credit or RTGS as applicable.
Eligible QFIs	QFIs from such jurisdictions outside India where it is not unlawful to make an offer or invitation under the Issue and in relation to whom the Prospectus constitutes an invitation to purchase the Equity Shares offered thereby and who have opened demat accounts with SEBI registered qualified depository participants
FII / Foreign Institutional Investors	Foreign Institutional Investor (as defined under SEBI (Foreign Institutional Investors) Regulations, 1995, as amended) registered with SEBI under applicable laws in India.
First/ Sole Applicant	The Applicant whose name appears first in the Application Form or Revision Form.
Foreign Venture Capital Investors	Foreign Venture Capital Investors registered with SEBI under the SEBI (Foreign Venture Capital Investor) Regulations, 2000.
FPI / Foreign Portfolio Investor	A Foreign Portfolio Investor who has been registered pursuant to the of Securities And Exchange Board of India (Foreign Portfolio Investors) Regulations, 2014, provided that any FII or QFI who holds a valid certificate of registration shall be deemed to be a foreign portfolio investor till the expiry of the block of three years for which fees have been paid as per the SEBI (Foreign Institutional Investors) Regulations, 1995, as amended
General Information Document (GID)	The General Information Document for investing in public issues prepared and issued in accordance with the circulars (CIR/CFD/DIL/12/2013) dated October 23, 2013, notified by SEBI and updated pursuant to the circular (CIR/CFD/POLICYCELL/11/2015) dated November 10, 2015 and (SEBI/HO/CFD/DIL/CIR/P/2016/26) dated January 21, 2016 notified by the SEBI.
GIR Number	General Index Registry Number.
IPO	Initial Public Offering
Listing Agreement	The Equity Listing Agreement to be signed between our Company and NSE.
LM / Lead Manager	Lead Manager to the Offer, in this case being Hem Securities Limited.
Lot Size	4000 shares
Market Maker	Member Brokers of NSE who are specifically registered as Market Makers with the SME Platform of NSE. In our case Hem Finlease Private Limited is the sole Market Maker
Market Making Agreement	The Market Making Agreement dated January 31, 2017 between our Company, Lead Manager and Market Maker
Market Maker Reservation Portion	The reserved portion of 3,36,000 Equity Shares of ₹ 10 each at an Offer price of ₹ 30.00 each aggregating to ₹ 100.80 Lakhs to be subscribed by Market Maker in this Offer.
Mutual Fund	A Mutual Fund registered with SEBI under the SEBI (Mutual Funds) Regulations, 1996, as amended.
Net Offer	The Offer (excluding the Market Maker Reservation Portion) of 62,40,000 equity Shares of ₹10 each at a price of ₹ 30.00 per Equity Share (the "Offer Price"), including a share premium of ₹ 20.00 per equity share.
Non-Institutional Investors	Investors other than Retail Individual Investors, NRIs and QIBs who apply for the Equity Shares of a value of more than ₹ 2,00,000/-
NSEL/NSE	National Stock Exchange of India Limited
NSE EMERGE	The SME platform of NSE, approved by SEBI as an SME Exchange for listing of equity shares offered under Chapter X-B of the SEBI ICDR Regulations.
Offer Agreement	The Agreement dated December 20, 2016 between our Company, Selling Shareholders and LM
Offer Closing Date	The date after which the Lead Manager, Syndicate Member, Designated Branches of SCSBs and Registered Brokers will not accept any Application for this Offer, which shall be notified in a English national newspaper, Hindi national newspaper and a regional newspaper each with wide circulation as required under the SEBI (ICDR) Regulations. In this case being February 16, 2017
Offer Opening Date	The date on which the Lead Manager, Syndicate Member, Designated Branches of SCSBs

Terms	Description
	and Registered Brokers shall start accepting Application for this Offer, which shall be the date notified in an English national newspaper, Hindi national newspaper and a regional newspaper each with wide circulation as required under the SEBI (ICDR) Regulations. In this case being February 13, 2017
Offer for Sale	Offer for sale of 65,76,000 Equity Shares being offered by the Selling Shareholders pursuant to the Prospectus.
Offer Period	The period between the Offer Opening Date and the Offer Closing Date, inclusive of both days, during which prospective Applicants can submit their Applications, including any revisions thereof.
Offer Price	The price at which Equity Shares will be issued by the Company in terms of this Prospectus i.e. ₹ 30.00 per share.
Offer Size	Public offering of 65,76,000 Equity Shares of ₹ 10 each vide an Offer for sale for cash at a price of ₹ 30.00 per share including a premium of ₹ 20.00 per equity share by the selling shareholders, in terms of this Prospectus
Other Investors	Investors other than Retail Individual Investors. These include individual applicants other than retail individual investors and other investors including corporate bodies or institutions irrespective of the number of specified securities applied for.
Overseas Corporate Body/OCB	Overseas Corporate Body means and includes an entity defined in clause (xi) of Regulation 2 of the Foreign Exchange Management (Withdrawal of General Permission to Overseas Corporate Bodies (OCB's) Regulations 2003 and which was in existence on the date of the commencement of these Regulations and immediately prior to such commencement was eligible to undertake transactions pursuant to the general permission granted under the Regulations. OCBs are not allowed to invest in this Offer.
Prospectus	The prospectus to be filed with the RoC in accordance with Section 32 of the Companies Act, containing, <i>inter alia</i> , the Offer Price will be determined before filing the Prospectus with RoC.
Public Offer Account	Account opened with the Bankers to the Offer to receive monies from the SCSBs from the bank account of the ASBA Applicant, on the Designated Date.
Qualified Institutional Buyers/ QIBs	A Mutual Fund, Venture Capital Fund and Foreign Venture Capital Investor registered with the SEBI, a foreign institutional investor and sub-account (other than a sub-account which is a foreign corporate or foreign individual), registered with the SEBI; a public financial institution as defined in Section 2(72) of the Companies Act, 2013; a scheduled commercial bank; a multilateral and bilateral development financial institution; a state industrial development corporation; an insurance company registered with the Insurance Regulatory and Development Authority; a provident fund with minimum corpus of ₹ 25.00 Crore; a pension fund with minimum corpus of ₹ 25.00 Crore; National Investment Fund set up by resolution No. F. No. 2/3/2005 – DDII dated November 23, 2005 of the Government of India published in the Gazette of India, insurance funds set up and managed by army, navy or air force of the Union of India and insurance funds set up and managed by the Department of Posts, India.
Registrar/ Registrar to the Offer/ RTA/ RTI	Registrar to the Offer being Link Intime India Private Limited.
Registrar Agreement	The agreement dated December 20, 2016, entered into between our Company, the Selling Shareholders and the Registrar to the Offer in relation to the responsibilities and obligations of the Registrar to the Offer pertaining to the Offer.
Retail Individual Investors	Individual investors (including HUFs, in the name of Karta and Eligible NRIs) who apply for the Equity Shares of a value of not more than ₹ 2,00,000.
Registered Broker	Individuals or companies registered with SEBI as "Trading Members" (except Syndicate/Sub-Syndicate Members) who hold valid membership of either BSE or NSE having right to trade in stocks listed on Stock Exchanges, through which investors can buy or sell securities listed on stock exchanges, a list of which is available on <a href="http://www.nseindia.com/membership/content/cat_of_mem.htm">http://www.nseindia.com/membership/content/cat_of_mem.htm</a>
Revision Form	The form used by the applicants to modify the quantity of Equity Shares in any of their Application Forms or any previous Revision Form(s).
Reservation Portion	The portion of the Offer reserved for category of eligible Applicants as provided under the



Terms	Description
	SEBI (ICDR) Regulations, 2009
Reserved Category/ Categories Regulations	Categories of persons eligible for making application under reservation portion. SEBI (Issue of Capital and Disclosure Requirement) Regulations, 2009 as amended from time to time.
Registrar and Share Transfer Agents or RTAs	Registrar and share transfer agents registered with SEBI and eligible to procure Applications at the Designated RTA Locations in terms of circular no.CIR/CFD/POLICYCELL/11/2015 dated November 10, 2015 issued by SEBI
SEBI SAST / SEBI (SAST) Regulations	SEBI (Substantial Acquisition of Shares and Takeovers) Regulations, 2011 as amended
SEBI Listing Regulations	Securities and Exchange Board of India (Listing Obligations and Disclosure Requirements) Regulations, 2015
Self Certified Syndicate Bank(s) / SCSB(s)	Banks which are registered with SEBI under the Securities and Exchange Board of India (Bankers to an Offer) Regulations, 1994 and offer services of ASBA, including blocking of bank account, a list of which is available <a href="http://www.sebi.gov.in/pmd/scsb.pdf">http://www.sebi.gov.in/pmd/scsb.pdf</a>
SME Exchange	SME Platform of the NSE
SEBI(PFUTP) Regulations/PFUTP Regulations	SEBI (Prohibition of Fraudulent and Unfair Trade Practices relating to Securities Markets) Regulations, 2003
Share Escrow Agreement	The Share Escrow Agreement dated January 31, 2017 between our Company, Selling Shareholders, Lead Manager and Escrow Agent.
Transaction Registration Slip/ TRS	The slip or document issued by a member of the Syndicate or an SCSB (only on demand), as the case may be, to the applicants, as proof of registration of the Application
Underwriters	The LM who has underwritten this Offer pursuant to the provisions of the SEBI (ICDR) Regulations and the Securities and Exchange Board of India (Underwriters) Regulations, 1993, as amended from time to time.
Underwriting Agreement	The Agreement dated January 31, 2017 entered between the Underwriter, LM, Selling Shareholders and our Company.
U.S. Securities Act	U.S. Securities Act of 1933, as amended
Venture Capital Fund	Foreign Venture Capital Funds (as defined under the Securities and Exchange Board of India (Venture Capital Funds) Regulations, 1996) registered with SEBI under applicable laws in India.
Working Day	Any day, other than Saturdays or Sundays, on which commercial banks in India are open for business, provided however, for the purpose of the time period between the Offer Opening Date and listing of the Equity Shares on the Stock Exchanges, "Working Days" shall mean all trading days excluding Sundays and bank holidays in India in accordance with the SEBI circular no. SEBI/HO/CFD/DIL/CIR/P/2016/26 dated January 21, 2016.

### Technical and Industry Related Terms

Terms	Full Form
BRP	Beneficiated Rock Phosphate
Bn	Billion
CAN	Calcium Ammonium Nitrate
CIS	Commonwealth of Independent States
DAP	Diammonium Phosphate
DoF	Department of Fertilizers
ECA	Essential Commodities Act, 1955
EMDEs	Emerging Market and Developing Economies
EME	Emerging Market Economies
FACT	Fertilizers & Chemicals Travancore of India
FAI	Fertilizers Association of India
FCI	Fertilizers Corporation of India
FCO	Fertilizer Control Order 1980
FD	Fixed Deposit
GSSP	Granulated Single Super Phosphate

HYV	High Yield Variety
ICAR	Indian Council of Agricultural Research
IEM	Industrial Entrepreneurs Memorandum
K	Potash
KPL	Krishana Phoschem Limited
KVA	Kilo-Vote-Ampere
LDCs	Least Developed Countries
MBAPL	Madhya Bharat Agro Products Limited
Mn	Million
MOP	Muriate of Potash
MT/MMT	Metric Tonnes
N	Nitrogenous
NBS	Nutrient Based Subsidy
NR IPL	Nirmala Realinfrastructure Private Ltd.
NPAAs	Non Performing Assets
NPS	New Pricing Scheme
OTS	One Time Settlement
OGI	Ostwal Group of Industries
OPIL	Ostwal Phoschem (India) Limited (formally known as Tedco Granite Limited)
OROP	One Rank One Pension
PSSP	Powder Single Super Phosphate
P	Phosphorus
P & K	Phosphatic & Potassic
P <sub>2</sub> O <sub>5</sub>	Phosphate
PSBs	Public Sector Banks
PPP	Purchasing Power Parity
R & D	Research And Development
RCPS	Redeemable Non Cumulative Preference Shares
RHC	Rougher Concentrate
RSMML	Rajasthan State Mines And Minerals Ltd
SA	Sulphuric Acid
SACIPL	Seasons Agro Chem India Pvt. Ltd.
SEIAA	State Level Environmental Impact Assessment Authority
SOP	Sulphate of Potash
SSP	Single Super Phosphate
SBBJ	State Bank of Bikaner & Jaipur
SIPL	Seasons International Private Limited
TPA	Tonnes Per Annum
TPD	Tonne Per Day
TPY	Tonnes Per Year
TSP	Triple Super Phosphate

## **ABBREVIATIONS**

<b>Abbreviation</b>	<b>Full Form</b>
AS / Accounting Standard	Accounting Standards as issued by the Institute of Chartered Accountants of India
A/c	Account
AGM	Annual General Meeting
ASBA	Applications Supported by Blocked Amount
AMT	Amount
AIF	Alternative Investment Funds registered under the Securities and Exchange Board of India (Alternative Investment Funds) Regulations, 2012, as amended.
AY	Assessment Year
AOA	Articles of Association

Abbreviation	Full Form
Approx	Approximately
B. A	Bachelor of Arts
B. Com	Bachelor of Commerce
B. E	Bachelor of Engineering
B. Sc	Bachelor of Science
B. Tech	Bachelor of Technology
Bn	Billion
BG/LC	Bank Guarantee / Letter of Credit
BIFR	Board for Industrial and Financial Reconstruction
BSE	BSE Limited (formerly known as the Bombay Stock Exchange Limited)
BSE SENSEX	Sensex in an index; market indicator of the position of stock that is listed in the BSE
CDSL	Central Depository Services (India) Limited
CAGR	Compounded Annual Growth Rate
CAN	Confirmation of Allocation Note
CA	Chartered Accountant
CB	Controlling Branch
CC	Cash Credit
CIN	Corporate Identification Number
CIT	Commissioner of Income Tax
CS	Company Secretary
CSR	Corporate social responsibility.
CS & CO	Company Secretary & Compliance Officer
CFO	Chief Financial Officer
CENVAT	Central Value Added Tax
CST	Central Sales Tax
CWA/ICWA	Cost and Works Accountant
CMD	Chairman and Managing Director
Depository or Depositories	NSDL and CDSL.
DIN	Director Identification Number
DIPP	Department of Industrial Policy and Promotion, Ministry of Commerce, Government of India
DP	Depository Participant
DP ID	Depository Participant's Identification Number
EBITDA	Earnings Before Interest, Taxes, Depreciation & Amortisation
ECS	Electronic Clearing System
ESIC	Employee's State Insurance Corporation
EPFA	Employees' Provident Funds and miscellaneous Provisions Act, 1952
EPS	Earnings Per Share
EGM /EOGM	Extraordinary General Meeting
ESOP	Employee Stock Option Plan
EXIM/ EXIM Policy	Export – Import Policy
FCNR Account	Foreign Currency Non Resident Account
FIPB	Foreign Investment Promotion Board
FY / Fiscal/Financial Year	Period of twelve months ended March 31 of that particular year, unless otherwise stated
FEMA	Foreign Exchange Management Act, 1999 as amended from time to time, and the regulations framed there under.
FCNR Account	Foreign Currency Non Resident Account
FBT	Fringe Benefit Tax
FDI	Foreign Direct Investment
FIs	Financial Institutions
FIIs	Foreign Institutional Investors (as defined under Foreign Exchange Management (Transfer or Issue of Security by a Person Resident outside India) Regulations, 2000) registered with SEBI under applicable laws in India
	“Foreign Portfolio Investor” means a person who satisfies the eligibility criteria prescribed under

Abbreviation	Full Form
FPIs	regulation 4 and has been registered under Chapter II of Securities And Exchange Board of India (Foreign Portfolio Investors) Regulations, 2014, which shall be deemed to be an intermediary in terms of the provisions of the SEBI Act,1992.
FTA	Foreign Trade Agreement.
FTP	Foreign Trade Policy, 2009
FVCI	Foreign Venture Capital Investors registered with SEBI under the Securities and Exchange Board of India (Foreign Venture Capital Investors) Regulations, 2000.
FV	Face Value
GoI/Government	Government of India
GDP	Gross Domestic Product
GAAP	Generally Accepted Accounting Principles in India
GST	Goods and Service Tax
GVA	Gross Value Added
HUF	Hindu Undivided Family
ICAI	The Institute of Chartered Accountants of India
ICWAI	The Institute of Cost Accountants of India
IMF	International Monetary Fund
INR / ₹/ Rupees	Indian Rupees, the legal currency of the Republic of India
IIP	Index of Industrial Production
IPO	Initial Public Offer
ICSI	The Institute of Company Secretaries of India
IFRS	International Financial Reporting Standards
HNI	High Net Worth Individual
i.e	That is
I.T. Act	Income Tax Act, 1961, as amended from time to time
IT Authorities	Income Tax Authorities
IT Rules	Income Tax Rules, 1962, as amended, except as stated otherwise
Indian GAAP	Generally Accepted Accounting Principles in India
IRDA	Insurance Regulatory and Development Authority
KMP	Key Managerial Personnel
LM	Lead Manager
Ltd.	Limited
MAT	Minimum Alternate Tax
MoF	Ministry of Finance, Government of India
M-o-M	Month-On-Month
MOU	Memorandum of Understanding
M. A	Master of Arts
M. B. A	Master of Business Administration
M. Com	Master of Commerce
MD	Managing Director
Mn	Million
M.P.	Madhya Pradesh
M. E	Master of Engineering
MRP	Maximum Retail Price
M. Tech	Masters of Technology
Merchant Banker	Merchant Banker as defined under the Securities and Exchange Board of India (Merchant Bankers) Regulations, 1992
MAPIN	Market Participants and Investors Database
MSMEs	Micro, Small and medium Enterprises
MoA	Memorandum of Association
NA	Not Applicable
Networth	The aggregate of paid up Share Capital and Share Premium account and Reserves and Surplus(Excluding revaluation reserves) as reduced by aggregate of Miscellaneous Expenditure(to the extent not written off) and debit balance of Profit & Loss Account

Abbreviation	Full Form
NEFT	National Electronic Funds Transfer
NECS	National Electronic Clearing System
NAV	Net Asset Value
NPV	Net Present Value
NRIs	Non Resident Indians
NRE Account	Non Resident External Account
NRO Account	Non Resident Ordinary Account
NSE	National Stock Exchange of India Limited
NOC	No Objection Certificate
NSDL	National Securities Depository Limited
OCB	Overseas Corporate Bodies
P.A.	Per Annum
PF	Provident Fund
PG	Post Graduate
PAC	Persons Acting in Concert
P/E Ratio	Price/Earnings Ratio
PAN	Permanent Account Number
PAT	Profit After Tax
PBT	Profit Before Tax
PLI	Postal Life Insurance
POA	Power of Attorney
PSU	Public Sector Undertaking(s)
Pvt.	Private
RBI	The Reserve Bank of India
ROE	Return on Equity
R&D	Research & Development
RONW	Return on Net Worth
RTGS	Real Time Gross Settlement
SCRA	Securities Contracts (Regulation) Act, 1956, as amended from time to time
SCRR	Securities Contracts (Regulation) Rules, 1957, as amended from time to time
SCSB	Self Certified Syndicate Banks
SEBI	Securities and Exchange Board of India
SICA	Sick Industrial Companies (Special provisions) Act, 1985, as amended from time to time
SME	Small and Medium Enterprises
STT	Securities Transaction Tax
Sec.	Section
SPV	Special Purpose Vehicle
TAN	Tax Deduction Account Number
TRS	Transaction Registration Slip
TIN	Taxpayers Identification Number
US/United States	United States of America
USD/ US\$/ \$	United States Dollar, the official currency of the Unites States of America
VCF / Venture Capital Fund	Foreign Venture Capital Funds (as defined under the Securities and Exchange Board of India (Venture Capital Funds) Regulations, 1996) registered with SEBI under applicable laws in India.
VAT	Value Added Tax
w.e.f.	With effect from
YoY	Year over Year

The words and expressions used but not defined in this Prospectus will have the same meaning as assigned to such terms under the Companies Act, the Securities and Exchange Board of India Act, 1992 (the “SEBI Act”), the SCRA, the Depositories Act and the rules and regulations made thereunder.

Notwithstanding the foregoing, terms in “Main Provisions of the Articles of Association”, “Statement of Tax Benefits”, “Industry Overview”, “Regulations and Policies in India”, “Financial Information of the Company”, “Outstanding Litigation and Material Developments” and “Part B” of “Offer Procedure”, will have the meaning ascribed to such terms in these respective sections.

## **CERTAIN CONVENTIONS, USE OF FINANCIAL INFORMATION AND MARKET DATA AND CURRENCY OF FINANCIAL PRESENTATION**

### **Certain Conventions**

All references in the Prospectus to “India” are to the Republic of India. All references in the Prospectus to the “U.S.”, “USA” or “United States” are to the United States of America.

In this Prospectus, the terms “we”, “us”, “our”, the “Company”, “our Company”, “Krishana Phoschem Limited” and “KPL”, unless the context otherwise indicates or implies, refers to Krishana Phoschem Limited. In this Prospectus, unless the context otherwise requires, all references to one gender also refers to another gender and the word “Lac / Lakh” means “one hundred thousand”, the word “million (mn)” means “Ten Lac / Lakh”, the word “Crore” means “ten million” and the word “billion (bn)” means “one hundred crore”. In this Prospectus, any discrepancies in any table between total and the sum of the amounts listed are due to rounding-off.

### **Use of Financial Data**

Unless stated otherwise, throughout this Prospectus, all figures have been expressed in Rupees and Lakh. Unless stated otherwise, the financial data in the Prospectus is derived from our financial statements prepared and restated for the period ended November 30, 2016 and financial year ended 31 March 2016, 2015, 2014, 2013 and 2012 in accordance with Indian GAAP, the Companies Act and SEBI (ICDR) Regulations, 2009 included under Section titled “Financial Information of the Company” beginning on page 157 of this Prospectus. Our Company does not have a subsidiary. Accordingly, financial information relating to us is presented on a Standalone basis. Our fiscal year commences on April 1 of every year and ends on March 31st of every next year.

There are significant differences between Indian GAAP, the International Financial Reporting Standards (“IFRS”) and the Generally Accepted Accounting Principles in the United States of America (“U.S. GAAP”). Accordingly, the degree to which the Indian GAAP financial statements included in this Prospectus will provide meaningful information is entirely dependent on the reader’s level of familiarity with Indian accounting practice and Indian GAAP. Any reliance by persons not familiar with Indian accounting practices on the financial disclosures presented in this Prospectus should accordingly be limited. We have not attempted to explain those differences or quantify their impact on the financial data included herein, and we urge you to consult your own advisors regarding such differences and their impact on our financial data.

Any percentage amounts, as set forth in “Risk Factors”, “Our Business”, “Management’s Discussion and Analysis of Financial Condition and Results of Operations” and elsewhere in the Prospectus unless otherwise indicated, have been calculated on the basis of the Company’s restated financial statements prepared in accordance with the applicable provisions of the Companies Act, Indian GAAP and restated in accordance with SEBI (ICDR) Regulations, as stated in the report of our Peer Review Auditor, set out in section titled “Financial Information of the Company” beginning on page 157 of this Prospectus.

For additional definitions used in this Prospectus, see the section Definitions and Abbreviations on page 1 of this Prospectus. In the section titled “Main Provisions of Articles of Association”, on page 294 of the Prospectus defined terms have the meaning given to such terms in the Articles of Association of our Company.

### **Use of Industry & Market Data**

Unless stated otherwise, industry and market data and forecast used throughout the Prospectus was obtained from internal Company reports, data, websites, Industry publications report as well as Government Publications. Industry publication data and website data generally state that the information contained therein has been obtained from sources believed to be reliable, but that their accuracy and completeness and underlying assumptions are not guaranteed and their reliability cannot be assured.

Although, we believe industry and market data used in the Prospectus is reliable, it has not been independently verified by us or the LM or any of their affiliates or advisors. Similarly, internal Company reports and data, while believed by us to be reliable, have not been verified by any independent source. There are no standard data gathering methodologies in the industry in which we conduct our business and methodologies and assumptions may vary widely among different market and industry sources.

In accordance with the SEBI (ICDR) Regulations, the section titled “Basis for Offer Price” on page 74 of the Prospectus includes information relating to our peer group companies. Such information has been derived from publicly available sources, and neither

we, nor the LM, have independently verified such information.

**Currency of Financial Presentation and Exchange Rates**

All references to "Rupees" or "INR" or "₹" are to Indian Rupees, the official currency of the Republic of India. Except where specified, including in the section titled "Industry Overview" throughout the Prospectus all figures have been expressed in thousands, Lakhs/Lacs, Million and Crores.

Any percentage amounts, as set forth in "Risk Factors", "Our Business", "Management's Discussion and Analysis of Financial Conditions and Results of Operation" on page 16, 91 & 192 in the Prospectus, unless otherwise indicated, have been calculated based on our restated respectively financial statement prepared in accordance with Indian GAAP.

The Prospectus contains conversions of certain US Dollar and other currency amounts into Indian Rupees that have been presented solely to comply with the requirements of the SEBI (ICDR) Regulations. These conversions should not be construed as a representation that those US Dollar or other currency amounts could have been, or can be converted into Indian Rupees, at any particular rate.



## FORWARD LOOKING STATEMENTS

This Prospectus includes certain “forward-looking statements”. We have included statements in the Prospectus which contain words or phrases such as “will”, “aim”, “is likely to result”, “believe”, “expect”, “will continue”, “anticipate”, “estimate”, “intend”, “plan”, “contemplate”, “seek to”, “future”, “objective”, “goal”, “project”, “should”, “will pursue” and similar expressions or variations of such expressions, that are “forward-looking statements”. Also, statements which describe our strategies, objectives, plans or goals are also forward looking statements.

All forward looking statements are subject to risks, uncertainties and assumptions about us that could cause actual results to differ materially from those contemplated by the relevant forward-looking statement. Forward-looking statements reflect our current views with respect to future events and are not a guarantee of future performance. These statements are based on our management’s beliefs and assumptions, which in turn are based on currently available information. Although we believe the assumptions upon which these forward-looking statements are based are reasonable, any of these assumptions could prove to be inaccurate, and the forward-looking statements based on these assumptions could be incorrect. Important factors that could cause actual results to differ materially from our expectations include but are not limited to:

1. Heavy dependence on Supply of Raw Material i.e. Rock Phosphate
2. Disruption in our manufacturing facilities.
3. Inability to sustain or manage our growth.
4. Failure to comply with regulations prescribed by authorities of the jurisdictions in which we operate;
5. Inability to successfully obtain registrations in a timely manner or at all;
6. General economic and business conditions in the markets in which we operate and in the local, regional and national economies;
7. Our ability to effectively manage a variety of business, legal, regulatory, economic, social and political risks associated with our operations;
8. Changes in laws and regulations relating to the industries in which we operate;
9. Effect of lack of infrastructure facilities on our business;
10. Increase in prices of Raw Material
11. Occurrence of Environmental Problems & Uninsured Losses;
12. Intensified competition in industries/sector in which we operate;
13. Our ability to successfully implement our growth strategy and expansion plans;
14. Our ability to meet our capital expenditure requirements;
15. Our ability to attract, retain and manage qualified personnel;
16. Failure to adapt to the changing technology in our industry of operation may adversely affect our business and financial condition;
17. Changes in political and social conditions in India or in countries that we may enter, the monetary and interest rate policies of India and other countries, inflation, deflation, unanticipated turbulence in interest rates, equity prices or other rates or prices;
18. Conflicts of interest with affiliated companies, the promoter group and other related parties;
19. The performance of the financial markets in India and globally;
20. Any adverse outcome in the legal proceedings in which we are involved;
21. Our ability to expand our geographical area of operation;
22. Concentration of ownership among our Promoters.

For further discussion of factors that could cause our actual results to differ, see the Section titled “Risk Factors”; “Our Business” & and “Management’s Discussion and Analysis of Financial Condition and Results of Operations” beginning on page 16, 91 & 192 respectively of the Prospectus. By their nature, certain market risk disclosures are only estimates and could be materially different from what actually occurs in the future. As a result, actual future gains or losses could materially differ from those that have been estimated.

Neither our Company, our Directors, Selling Shareholders, our Officers, Lead Manager and Underwriter nor any of their respective affiliates have any obligation to update or otherwise revise any statements reflecting circumstances arising after the date hereof or to reflect the occurrence of underlying events, even if the underlying assumptions do not come to fruition. In accordance with SEBI requirements, our Company, Selling Shareholders and the Lead Manager will ensure that investors in India are informed of material developments until such time as the grant of listing and trading permission by the Stock Exchange for the Equity Shares allotted pursuant to this Offer.

## SECTION II: RISK FACTORS

An investment in Equity Shares involves a high degree of risk. You should carefully consider all the information in this Prospectus, including the risks and uncertainties described below, before making an investment in our Equity Shares. To obtain a better understanding, you should read this section together with "Our Business" and "Management's Discussion and Analysis of Financial Condition and Results of Operations" on pages 91 and 192, respectively, as well as the other financial and statistical information contained in this Prospectus. The risks and uncertainties described in this section are not the only risks that we may face. Additional risks and uncertainties not known to us or that we currently believe to be immaterial may also have an adverse effect on our business, results of operations, financial condition and prospects.

If any of the following risks, or other risks that are not currently known or are now deemed immaterial, actually occur, our cash flows, business, financial condition and results of operations could suffer, the price of our Equity Shares could decline, and you may lose all or part of your investment. The financial and other related implications of risks concerned, wherever quantifiable, have been disclosed in the risk factors mentioned below. However, there are risks where the impact is not quantifiable and hence the same has not been disclosed in such risk factors. Investment in equity and equity related securities involve a degree of risk and investors should not invest any funds in this Offer unless they can afford to take the risk of losing their investment. Investors are advised to read the risk factors carefully before taking an investment decision in this Offer. Before making an investment decision, investors must rely on their own examination of the Offer and us.

This Prospectus contains forward-looking statements that involve risks and uncertainties. Our actual results could differ materially from those anticipated in these forward-looking statements as a result of certain factors, including the considerations described below and elsewhere in this Prospectus. The financial and other related implications of risks concerned, wherever quantifiable, have been disclosed in the risk factors below. However, there are risk factors the potential effects of which are not quantifiable and therefore no quantification has been provided with respect to such risk factors. In making an investment decision, prospective investors must rely on their own examination of our Company and the terms of the Offer, including the merits and the risks involved. You should not invest in this Offer unless you are prepared to accept the risk of losing all or part of your investment, and you should consult your tax, financial and legal advisors about the particular consequences to you of an investment in our Equity Shares.

In this Prospectus, any discrepancies in any table between total and the sums of the amount listed are due to rounding off. Any percentage amounts, as set forth in "Risk Factors" on page 16 and "Management Discussion and Analysis of Financial Condition and Results of Operations" on page 192 respectively of this Prospectus unless otherwise indicated, has been calculated on the basis of the amount disclosed in the "Financial Information of the Company" prepared in accordance with the Indian Accounting Standards.

### INTERNAL RISK FACTORS

- There is outstanding litigation against our Company, our Corporate Promoters and our Group Companies, which if determined adversely, could affect our business and results of operations.***

Our Company, our corporate promoters, our Group Companies are defendants in certain legal proceedings. These legal proceedings are pending at different levels of adjudication before various courts and tribunals. The amounts claimed in these proceedings have been disclosed to the extent ascertainable and include amounts claimed jointly and severally from us and other parties. Any new developments arise, such as any change in applicable Indian law or any rulings against us by appellate courts or tribunals, we may need to make provisions in our financial statements that could increase expenses and current liabilities. Any adverse decision may have an effect on our business, results of operations and financial condition.

*Litigation against our Company:-*

Nature of Litigation	Number of Cases Outstanding	Amount Involved (in Lacs)
Criminal Litigation	--	--
Action against Statutory & Regulatory Authorities	--	--
Taxation Liabilities (Indirect Tax)	1	0.42
Other Litigation	1	Not ascertainable

*Litigation against our Corporate Promoters & Group Companies:-*

<b>Nature of Litigation</b>	<b>Number of Cases Outstanding</b>	<b>Amount Involved (in Lacs)</b>
Criminal Litigation	--	--
Action against Statutory & Regulatory Authorities	1	Not ascertainable
Taxation Liabilities (Direct Tax)	5	Not ascertainable
Other Litigation	18	1.29

*Litigation filed by our Corporate Promoters & Group Companies:-*

<b>Nature of Litigation</b>	<b>Number of Cases Outstanding</b>	<b>Amount Involved (in Lacs)</b>
Criminal Litigation	2	1.30
Action against Statutory & Regulatory Authorities	2	19.81
Taxation Liabilities (Direct Tax)	--	--
Other Litigation	3	194.52

For further details, please see "*Outstanding Litigation and Material Developments*" on page 205 of this Prospectus.

**2. Our revenues are dependent upon our major customer i.e. Shriram Fertilizers & Chemicals Limited (a unit of DCM Shriram Limited). The loss of our major client would have an effect on our business operations and profitability.**

Our Company has entered into Supply and Purchase Agreement dated March 20, 2015 with Shriram Fertiliser & Chemicals Limited (a unit of DCM Shriram Limited) for Supply of Super Single Phosphate (SSP) for period of five year beginning from April 01, 2015. For the financial year ended March 31, 2016 and November 30, 2016, our top client accounted up to 100% of total sales of the company. The loss of this significant customer would have an effect on our financial results. We cannot assure you that we can maintain the historical levels of business from this customer or that we will be able to replace this customer in case we lose it. Furthermore, major events affecting our customer, such as change of management, mergers and acquisitions could impact our business. If our customer becomes insolvent, we may lose some or all of our business from that client and our receivable from that client would increase and may have to be written off, impacting our income and financial condition.

For further details of our customer, please refer section titled "Management discussion and Analysis of Financial Conditions and Result of Operation" beginning on Page 192 of this Prospectus.

**3. We regularly work with hazardous materials such as Sulphuric Acid in our operations which can be dangerous and could cause uncertainties.**

Our manufacturing process involves certain flammable material which are potentially dangerous circumstances such as Sulphuric acid. For example, if improperly handled, Sulphuric Acid can seriously cause damage to our properties and the properties of others. Despite compliance with requisite safety requirements and standards, our operations are subject to significant hazards, including:

- Explosions;
- fires;
- Mechanical failures and other operational problems;
- Inclement weather and natural disasters;
- Discharges or releases of hazardous substances, chemicals or gases; and
- Other environmental risks.

The loss or shutting down of our facilities due to uncertainty cause by hazardous material, could disrupt our business operations and affect our results of operations, financial condition.

For further details of our manufacturing process and use of Sulphuric acid, Please refer to section titled "Our Business" beginning on Page 91 of this Prospectus.

**4. We require certain approvals and licenses in the ordinary course of business, and the failure to obtain or retain them in a timely manner may materially affect our operations.**

We require certain approvals, licences, registrations and permissions for operating our business, if we fail to obtain or retain any of these approvals or licenses, or renewals thereof, in a timely manner, our business may be affected. Also the registered office of our company as well as the godown taken by the Company on lease for business purposes are not registered under Rajasthan Shop and Commercial Establishment Act, 1958. Furthermore, our government approvals and licenses are subject to numerous conditions, some of which are onerous and require us to make substantial compliance-related expenditure. If we fail to comply or a regulator claims that we have not complied with these conditions, our business, prospects, financial condition and results of operations may be affected.

For details see “Government and Other Approvals” beginning on page 222 of this Prospectus.

**5. Our Registered Office and godown have been taken by us on lease and the lease deeds of which are not registered. Our operations may be affected if we are unable to continue to utilize our registered Office & godown in future.**

Our business is operated from our registered office situated at 5-O-20 Basement R.C Vyas Colony Bhilwara, Rajasthan which is leased premise. We have entered into lease arrangements for our registered Office with our Corporate Promoter Ostwal Phoschem (India) Limited for fifteen years commencing from May 01, 2015. Also our godown is taken on lease from our corporate Promoters i.e. Seasons Agro Chem (India) Private Limited for period of three year commencing form December 23, 2015. If we are unable to continue to use our registered Office and godown which are located on leased premises during the period of the relevant lease or extend such lease on its expiry on commercially acceptable terms, or at all, we may suffer a disruption in our operations which could have an effect on our business and results of operations. We cannot assure you that we will have the right to occupy, the aforementioned premises in future, or that we will be able to continue with the uninterrupted use of this property, which may impair our operations and affect our financial condition. In addition to above our lease Agreement for registered office and godown are not registered and the said non-registration amount to non-compliance of Registration Act, 1908 and Indian Stamp Act, 1899 for non-payment of stamp duty on registration. For further details of our registered office and godown please refer to the chapter titled “Our Business” on page 91 of this Prospectus.

**6. Few forms filed by us with the RoC had factual inaccuracies and our company had not complied with certain provision of Companies Act, 1956 in past. If the authorities impose monetary penalties on us or take certain punitive actions against our Company in relation to the same, our business, financial condition and results of operations could be affected.**

In the past, we have not complied with certain provisions of Companies Act includes the non filing of few ROC forms in relation to allotment of equity shares in FY 2006 & 2008 and also for appointment of whole-time director in the year of 2009. Additionally our Company have not complied with the Unlisted Public Companies (Preferential Allotment) Rules, 2003 & amended thereon and Companies Act, 2013 read with Companies (Share capital and debentures) Rules, 2014 with respect to the few Preferential allotment. Also the company had filed Annual return for the year 2005-06 & 2006-07 with some factual discrepancies with regards to shares transfers and the Company has paid salaries to relatives of Directors in the past. In Addition to above, our company has made non-compliances for non-payment of Stamp duty on allotment of shares. Also our Company has not complied with some Accounting Standard i.e. 6, 15 and 18 in financial Statement of the Company. However, now the Company has made necessary compliance in accordance with the Accounting Standards in the restated financial statements of the Company.

Further the provisions of CSR are applicable on Company and it has a CSR policy & CSR Committee formed under the provisions of Companies Act 2013 and also we believe that the expenses incurred by us are covered under corporate social responsibility (CSR) but if any of expenses made by us towards CSR activities are disallowed by concerned authority which may subject to any actions as per section 135 read with Companies (Corporate Social Responsibility Policy) Rules, 2014.

Although no show cause notice have been issued against our Company till date in respect of above, in the event of any cognizance being taken by the concerned authorities in respect of above, actions may be taken against our Company and its directors, in which event the financials of our Company and our directors may be affected.

**7. Our Company has recently diversified its business by manufacturing Intermediate Dyes and Other Chemicals in Unit – II from September, 2016. Lack of experience in field of chemicals may affect profitability of our Company.**

Our Company is engaged in manufacturing of BRP, SSP and GSSP in Unit – I and further our company has diversified its business in field of Intermediate Dyes and Other Chemicals in Unit – II and started the commercial production from September, 2016. We

have limited operational efficiency in fields of chemical manufacturing which may impact our profitability and increase the fixed cost incurred in manufacturing process. For further details of our financial position and information please refer to section titled "Financial Information of the Company" on page 157 of this Prospectus.

For further details of our business and diversification in dyes and chemicals, please refer to the chapter titled "Our Business" on page 91 of this Prospectus.

**8. *Some of our historical and secretarial records are not traceable. Non-availability of these records exposes us to the risk of penalties that may be imposed by the competent regulatory authority in future.***

Due to change in methods of record keeping on account of technological advancement and computerization, over the years, certain forms filed with ROC before 2006 could not be traced by our Company. We believe that our Company has filed these records with RoC on a timely basis. Our Company cannot assure you that these form filings will be available in the future or that it will not be subject to any penalty imposed by the competent regulatory authority in this respect. If RoC initiates proceedings for any actual or perceived irregularity in our compliance with reporting requirements in any future or historic periods, there may be an effect on our business, results of operation and financial condition.

In addition to above, Our Company was taken over by Mr. Praveen Ostwal & Seasons Agro Chem India Pvt. Ltd. in June, 2007 and subsequently the management of the Company was changed by appointment of Mr. Praveen Ostwal as director and an MOU was entered for acquisition of shares and change in management of the company but the same is not available in records of the Company. If any dispute arise relating to acquisition and takeover of the business or change in management of the company, the same will impact the operations of the Company.

**9. *We do not have formal arrangements with our suppliers for purchase of Rock Phosphate. Any disturbance in procurement of Raw material could have an effect on our business, results of operations and financial condition.***

Our Company is engaged in manufacturing of BRP, SSP, GSSP and Intermediate Dyes & Other chemicals which required Rock Phosphate as major raw material for manufacturing the same. Our Company has signed a memorandum of Understanding (MOU) with Madhya Pradesh State Mining Corporation Limited (MPSMC) for supply of Rock Phosphate for period of 10 years beginning from the year 2004. After expiry of said Memorandum of Understanding, our company has not able to renew such MOU for supply of Rock Phosphate. Although we have been procuring our raw material from MPSMC but we do not have any formal arrangement for such supply. Also we import our raw material from international open market. Any disturbance in procurement of Raw material due to absence of formal agreement and any disturbance in importing our raw material could have an effect on our business, results of operations and financial condition.

**10. *Our Company is not having its own Distribution Network for sale of Products.***

Presently our Company is marketing its product through our marketer Shriram Fertilizer & Chemical Limited (a unit of DCM Shriram Limited) and does not have its own Distribution Network. Although our Company has signed a Supply and Purchase agreement dated March 20, 2015 for supply of 40000 MT per annum for the period of five year beginning from April 01, 2015. Further if our inability to maintain our existing distribution network or to expand it further as per the requirement of our proposed increased Capacities, the same can affect our business, reputation and financial condition.

For further details of our business and distribution network, please refer to the chapter titled "Our Business" on page 91 of this Prospectus.

**11. *We are highly dependent on our management team and certain management personnel, any loss of such team members or the inability to attract or retain personnel may materially affect our business performance.***

Our business and the implementation of our strategies are dependent upon our management team, who oversee our day-to-day operations, strategy and growth of our business. If one or more members of such management team is unable or unwilling to continue in their present positions, such persons would be difficult to replace and our business, prospects and results of operations could be affected.

In addition, our success in expanding our business will also depend, in part, on our ability to attract, retain and motivate mid-to senior management personnel. Our failure to successfully manage our personnel needs could affect our business prospects and results of operations. These risks could be heightened to the extent we invest in businesses or geographical regions in which we

have limited experience. If we are not able to address these risks, our business, results of operations and financial condition could be affected.

For further details of our managerial personals, please refer to the chapter titled “Our Management” on page 127 of this Prospectus.

***12. The geographical concentration of our manufacturing facilities may restrict our operations and affect our business and financial conditions.***

We conduct our manufacturing operations in India at Meghnagar, Madhya Pradesh. Due to the geographic concentration of our manufacturing operations and the operations of certain of our suppliers, our operations are susceptible to local and regional factors, such as accidents, system failures, economic and weather conditions, natural disasters, and demographic and population changes, and other unforeseen events and circumstances. Such disruptions could result in the damage or destruction of a significant portion of our manufacturing abilities, significant delays in shipments of our raw material and/or otherwise affect our business, financial condition and results of operations.

In addition, our manufacturing plants produce BRP, SSP and GSSP for a single customer i.e Shriram Fertilizers & Chemicals Limited (a unit of DCM Shriram Limited). Disruptions, damage or destruction of those plants may affect our ability to meet our customer demand and the loss of our key customer or a significant reduction in demand from such customers could have an effect on our business, results of operations and financial condition.

***13. Our financing agreements contain covenants that limit our flexibility in operating our business. If we are not in compliance with certain of these covenants and are unable to obtain waivers from our lender, our lenders may accelerate the repayment schedules, and enforce their respective security interests, leading to an effect on our business and financial condition.***

We are bound by restrictive and other covenants in our facility agreements with lender, including but not limited to, restrictions on the utilisation of the loan for certain specified purposes, timely provision of information and documents, timely creation of security, obtaining prior consent from existing lenders, maintenance of financial ratios and obtaining prior written approval from the appropriate lender for various corporate actions. If we are not in compliance with certain of these covenants and are unable to obtain waivers from all of our lenders, our lenders may accelerate the repayment schedules. Subsequently, if we are unable to pay our debt, affected lenders could also proceed against any collateral granted to them to secure such indebtedness. Furthermore, these covenant defaults can result in cross-defaults in our other debt financing agreements, and there can be no assurance that potential defaults will not result in future cross-defaults. If our lenders accelerate the repayment of our borrowings, we cannot assure you that we will have sufficient assets to repay amounts outstanding under our loan agreements or continue our business.

As of November 30, 2016, the aggregate indebtedness outstanding under these debt financing agreements was ₹ 2438.49 Lacs, which includes term loans and working capital loan from banks. For details, see “Statement of Financial Indebtedness” beginning on page 190 of this Prospectus.

***14. Our Company markets its products through Supply & Purchase Agreement with Shriram Fertiliser & Chemicals Limited (a unit of DCM Shriram Limited). In case of non-fulfillment of agreement obligations or cancellation of the agreement, under its terms or pre-maturely, we may not be able to generate the required sales and lose market share, thus affecting our revenues and profitability.***

Our Company has entered into Supply & Purchase Agreement with Shriram Fertiliser & Chemicals Limited (a unit of DCM Shriram Limited) for supply of SSP which is directly deliver to our client. In case the Shriram Fertiliser & Chemicals Limited (hereunder referred as “Customer”) revoke the agreement, or any non-fulfillment of the terms of the agreement our sales will be affected. In case of pre-mature cancellation of the agreement by our customer or non-renewal of the agreement upon expiry of the same, we cannot guarantee that we will be able to renew the same with trusted customers in the terms and conditions favorable to us or at all. In addition to above we packed our product in packing material with name of the Shriram Fertiliser & Chemicals Limited which is part of total sales amount charged by us. Also, we cannot ensure that we will be able to find a suitable customer with a wide enough network to sell our products successfully and unable to do so may reduce our market share eventually leading to reduction in our revenue. Although we maintain good relations with our customer such that we get maximum reach for our products, any disruption in the day-to-day execution of the same could affect the business and the profitability of our Company.

**15. We appoint contract labour for carrying out certain operations and we may be held responsible for paying the wages of such workers, if the independent contractors through whom such workers are hired default on their obligations, and such obligations could have an effect on our results of operations and financial condition.**

In order to retain flexibility and control costs, our Company appoints independent contractors who in turn engage on-site contract labour for performance of certain of our operations at our manufacturing facilities. Although our Company does not engage these labourers directly, we may be held responsible for any wage payments to be made to such labourers in the event of default by such independent contractors. Any requirement to fund their wage requirements may have an impact on our results of operations and financial condition. Additionally, non adherence of any regulatory compliance under the Contract Labour (Regulation and Abolition) Act, 1970, as amended will affect our business. Thus, any such order from a regulatory body or court may have an effect on our business, results of operations and financial condition.

**16. Increases in the prices of raw materials and labour, their availability, quality and cost overruns could have an adverse effect on us.**

The cost of raw materials and labour constitutes a significant part of our operating expenses. For e.g., the key raw material used in manufacturing of BRP, SSP and GSSP is Rock Phosphate. We are vulnerable to the risk of rising/fluctuating Rock Phosphate prices, which are determined by demand and supply conditions in the Indian markets as well as government policies. Any unexpected price fluctuations after placement of orders, shortage, delay in delivery, quality defects, or any factors beyond our control may result in an interruption in the supply of such materials which is critical to our business. In the event that we fail to secure sufficient quantities of such raw materials from our suppliers at acceptable quality and prices in a timely manner, our business, financial performance and cash flows may be affected. The quality of raw materials delivered by suppliers engaged by us has a direct impact on the overall quality of our production and the timeliness of our delivery to our customer. Although we generally ensure strict quality and process control measures for suppliers, we may be subject to potential claims against us by our clients in case of any sub-standard materials provided by our suppliers. In such circumstances and our business may be affected. In addition, our resources could be strained by any claim which proceeds to litigation which will affect the financial position of the Company.

**17. Our Company is using Logo of Ostwal Group of Industries which is registered in name of our Corporate Promoter. Also the trademark applied in the name of our company is opposed.**



Presently, our Company is using logo  of Ostwal Group of Industries and the same is not registered on name of our Company. Additionally our company has signed a Memorandum of Understanding dated November 24<sup>th</sup>, 2016 with our Promoter Company “Ostwal Phoschem (India) Limited (formerly known as Tedco Granite Limited)” for use of trademark. Also the logo of our Corporate Promoter is used by some of our Group Companies including our listed Group Company. In addition to above our company has applied for trademark in name of Krishana Phoschem Limited and status of the same is “opposed” as on date. As such, we do not enjoy the statutory protections accorded to a registered trademark on our name as on date. Also if in future we are unable to use the logo registered in name of our Group Company and any dispute arises for trademark applied on name of our company the same may cause damage to our business prospects.

For further details please refer to chapter titled “Our Business” beginning on page 91 of the Prospectus.

**18. Our contingent liabilities as stated in our Restated Financial Statements could affect our financial condition.**

Our Contingent liability as on November 30, 2016 was ₹ 0.42 Lacs. If this contingent liability materializes, fully or partly, the financial condition of our Company could be affected. The details of Contingent Liability as on November 30, 2016 as follows:-

S.No.	Particulars	Amount ( ₹ in Lacs)
1.	Indirect Tax demands/Notices/Appeals	0.42

For more information, regarding our contingent liabilities, please refer “Annexure R” in chapter titled “Financial Information of the Company” beginning on page 157 of this Prospectus.

**19. Our Company is engaged in manufacturing of SSP and received subsidy on sale of such product. Any discontinuation may decrease our Profitability.**

Our Company is engaged in manufacturing of SSP and entered into Supply and Purchase Agreement dated March 20, 2015 with Shriram Fertiliser & Chemicals Limited (a unit of DCM Shriram Limited) for Supply of Super Single Phosphate (SSP) for period of five year beginning from April 01, 2015 and also received subsidy on sale of SSP. The Subsidy realization is based on monthly sales made by our Company which is transfer from Shriram Fertiliser & Chemicals Limited in ratio of 85% (90% on Bank guarantee) of Subsidy on account and balance 10% after verification. The Subsidy on SSP reduces the manufacturing cost and increase the profitability of our company. Any discontinuance of subsidy from Government of India and reduction in amount of subsidy received may increase the cost of production and reduce the profitability which may impact the financial condition of our Company.

For further details please refer to chapter titled “Our Business” beginning on page 91 of the Prospectus.

**20. Our immovable properties i.e. manufacturing units of our company are leased. If we are unable to renew existing leases or relocate our operations on commercially reasonable terms, there may be an effect on our business, financial condition and operations.**

Our manufacturing units are located on land held by us on leasehold basis with M.P. Audyogik Kendra Vikas Nigam (Indore) Limited. The leases are long-term lease agreements. If we are unable to renew certain or all of these leases on commercially reasonable terms, we may suffer a disruption in our operations or be unable to continue to operate from those locations in the future (and may, to that extent, need to revise our raw material sourcing, product manufacturing and raw material and product inventory schedules and/or incur significant costs to relocate or expand our operations elsewhere in order to continue to honour our commitments to our customer). In addition, the terms of certain of our leases require us to obtain the lessor's prior consent for certain actions.

For further details of immovable properties, please refer to chapter titled “Our Business” beginning on page 91 of the Prospectus.

**21. Obsolescence, destruction, theft, breakdowns of our major plants or machineries or failures to repair or maintain the same may affect our business, cash flows, financial condition and results of operations**

Obsolescence, destruction, theft or breakdowns of our major plants or machineries may significantly increase our machineries purchase cost and the depreciation of our plants and machineries, as well as change the way our management estimates the useful life of our plants and machineries. In such cases, we may not be able to acquire new plants or machineries or repair the damaged plants or machineries in time or at all, particularly where our plants or machineries are not readily available from the market or require services from original machinery manufacturers. Some of our major machineries or parts may be costly to replace or repair. We may experience significant price increases due to supply shortages, inflation, transportation difficulties or unavailability. Such obsolescence, destruction, theft, breakdowns, repair or maintenance failures or price increases may not be adequately covered by the insurance policies availed by our Company and may have an effect our business, cash flows, financial condition and results of operations

For further details of our Plant and Machineries, please refer to chapter titled “Our Business” beginning on page 91 of the Prospectus.

**22. We may be subject to fine pursuant to delay in appointment of a whole-time Company secretary.**

Pursuant to an increase in our paid-up capital in September 2006, in terms of the Companies Act, 1956 we were required to have a whole-time company secretary. However, our company has appointed a whole-time company secretary in April 2009 resulting in delay during the period September 2006 – March 2009. However, Nitin Mehta was appointed as Company Secretary on April 01, 2009 and upon his resignation, Siddharth Modi was duly appointed as the whole-time Company Secretary and Compliance Officer w.e.f. dated March 12, 2011. We cannot assure you that the statutory authority will not impose any penalty or take any action against us which may impact our results of operations and cash flows. Such non compliance in the future may render us liable to statutory penalties.

**23. We depend on third parties for the supply of raw materials and delivery of products and such providers could fail to meet their obligations, which may have a effect on our business, results of operations and financial condition.**



We are dependent on third party suppliers for our raw materials. Discontinuation of production by these suppliers or a failure of these suppliers to adhere to the delivery schedule or the required quality could hamper our production schedule and therefore affect our business and results of operations. This dependence may also affect the availability of key materials at reasonable prices thus affecting our margins and may have an effect on our business, results of operations and financial condition. There can be no assurance that strong demand, capacity limitations or other problems experienced by our suppliers will not result in occasional shortages or delays in their supply of raw materials. If we were to experience a significant or prolonged shortage of raw materials from any of our suppliers, and we cannot procure the raw materials from other sources, we would be unable to meet our production schedules for our products and to deliver such products to our customer in timely manner, which would affect our sales, margins and customer relations. We cannot assure you that a particular supplier will continue to supply the required components or raw materials to us in the future. Any change in the supplying pattern of our raw materials can affect our business and profits.

Additionally, our company has entered into supply contract dated April 21, 2016 with Deepak Nitrate Limited for supply of diluted Sulphuric Acid for period of one year. If the supply contract is terminated or the supplier is not able to fulfill its commitment, our production facility will suffer and which directly affect our financial position.

For further details of our Suppliers, please refer section titled “Management discussion and Analysis of Financial Statement” beginning on Page 192 of this Prospectus.

**24. We may not have sufficient insurance coverage to cover our economic losses as well as certain other risks including those pertaining to claims by third parties and litigation.**

Our business involves many risks and hazards which may affect our profitability, including breakdowns, failure or substandard performance of equipment, third party liability claims, labour disturbances and infrastructure failure. Although our company has taken sufficient insurance to cover the uncertainty arises out of any situation. We cannot assure you that the operation of our business will not be affected by any of the incidents and hazards listed above. In addition, our company has not taken adequate coverage for Machinery Breakdown and insurance for Unit – III which is under installation Stage. Further, the Company also does not have any Group Personal Accident for the employees of its registered office as well as for employees of Unit II and III. If any uncertainty arises including losses arising on account of third party claims may impact our business. Also for those where insurance is taken, any amount of which exceed insurance limits, economic or consequential damages that are outside the scope of insurance coverage, and claims that are excluded from coverage may adversely affect our business. If our arrangements for insurance or indemnification are not adequate to cover claims, we may be required to make substantial payments and our results of operations and financial condition may be affected.

If our arrangements for insurance or indemnification are not adequate to cover claims, including those exceeding policy aggregate limitations or exceeding the resources of the indemnifying party, we may be required to make substantial payments and our results of operations and financial condition may be affected.

**25. The shortage or non-availability of power facilities may affect our manufacturing processes and have an adverse impact on our results of operations and financial condition.**

Our manufacturing processes requires substantial amount of power facilities. The quantum and nature of power requirements of our industry and Company is such that it cannot be supplemented/ augmented by alternative/ independent sources of power supply since it involve significant capital expenditure and per unit cost of electricity produced is very high in view of increasing oil prices and other constraints. We are mainly dependent on State Government for meeting our electricity requirements. Any defaults or non compliance of the conditions may render us liable for termination of the agreement or any future changes in the terms of the agreement may lead to increased costs, thereby affecting the profitability.

For further details, please refer to chapter titled “Our Business” beginning on page 91 of the Prospectus.

**26. Our Promoter Company have incurred losses in past and any operating losses in the future could affect the results of operations and financial conditions of our group companies.**

The details of profit and loss of our Group Company in past years are as follows:-

Name of the Group Company	Profit/ (Loss) for the year ended (Amount in Lacs)		
	31 <sup>st</sup> March 2016	31 <sup>st</sup> March 2015	31 <sup>st</sup> March 2014

Seasons Agro Chem India Pvt. Ltd.	45.81	38.81	(237.04)
-----------------------------------	-------	-------	----------

Any operating losses could affect the overall operations and financial conditions of the Group. For more information, regarding the Company, please refer chapter titled “Our Group Companies” beginning on page 148 of this Prospectus.

**27. Our Promoter and Promoter Group will continue to retain majority shareholding in us after the Offer, which will allow them to exercise significant influence over us.**

After the completion of the Offer, our Promoter and Promoter Group will hold approximately 57.25% of our outstanding Equity Shares. Accordingly, our Promoter and Promoter Group will continue to exercise significant influence over our business and all matters requiring shareholders' approval, including the composition of our Board of Directors, the adoption of amendments to our certificate of incorporation, the approval of mergers, strategic acquisitions or joint ventures or the sales of substantially all of our assets, and the policies for dividends, lending, investments and capital expenditures. This concentration of ownership may also delay, defer or even prevent a change in control of our Company and may make some transactions more difficult or impossible without the support of our Promoter and Promoter Group. Further, the Takeover Regulations may limit the ability of a third party to acquire control. The interests of our Promoter, as our Company's controlling shareholder, could conflict with our Company's interests, your interests or the interests of our other shareholders. There is no assurance that our Promoter will act to resolve any conflicts of interest in our Company's or your favour.

For further details regarding shareholding of our Promoter and Promoter Group, please refer to chapter titled “Capital Structure” beginning on page 54 of the Prospectus.

**28. The agricultural products business is highly seasonal in our country and such seasonality may adversely affect the demand for our fertilizers and also our operating results.**

We are engaged in the manufacturing of fertilizers, which is the raw material for the agricultural industry. We have two major crop season in our country namely Rabi & Kharif. The demand for our product is affected by the crop season and therefore the demand for our fertilizer is highly seasonal in nature. Further, majority of the farmers depend on rain for cultivation. Generally rainfall occurs during Kharif season and hence, the timing and seasonality of rainfall also impacts the business of our Company. Thus, we are subject to seasonal factors, which make our operating results relatively unpredictable.

For further details of our business, please refer to chapter titled “Our Business” beginning on page 91 of the Prospectus.

**29. Our Company requires significant amount of capital for continued growth. Our inability to meet our capital requirements may have an effect on our results of operations.**

Our business is capital intensive and requires significant amount of capital for running our manufacturing business. As on November 30, 2016, the outstanding amount under the borrowings (including secured and unsecured) of our Company is ₹ 2943.88 Lacs. We intend to continue growing by setting up additional manufacturing process of Sulphuric Acid and other chemicals. In addition to the requirement of funds presently sanctioned from our lenders, we may need to obtain additional financing in the normal course of business from time to time as we expand our operations. We may not be successful in obtaining additional funds in a timely manner and/or on favourable terms including rate of interest, primary security cover, collateral security, terms of repayment, or at all. Moreover, certain of our loan documentations contain provisions that limit our ability to incur future debt. If we do not have access to additional capital, we may be required to delay, scale back or abandon some or all of our plans or growth strategies or reduce capital expenditures and the size of our operations. Our inability to maintain sufficient cash flow, credit facility and other sources of fund, in a timely manner, or at all, to meet the requirement of working capital or pay out debts, could affect our financial condition and result of our operations.

For further details regarding borrowing of our company, please refer to chapter titled “Statement of Financial Indebtedness” beginning on page 190 of the Prospectus.

**30. Our Company is vulnerable to risk of environmental clearance from regulatory authority which may have an effect on our results of operations.**

Our business is operated from our factories situated at Meghnagar, Jhabua, Madhya Pradesh which is exposed to risk of environmental clearance from regulatory authority as our company is engaged in manufacturing of chemical products which are hazardous products and if any of regulatory authority impose any penalty and take any action against us will impact our operation. In addition any harm to our labour and our employees in factories will affect our manufacturing process and overall affect the operation of our Company.

For further details of our business and employees, please refer to chapter titled “Our Business: beginning on Page of 91 of this Prospectus.

**31. *We are subject to stringent labour laws and other industry standards and any strike, work stoppage or increased wage demand by our employees or any other kind of disputes with our employees could adversely affect our business, financial condition and results of operations.***

Our manufacturing activities are labour-intensive. As of November 30, 2016, we had 64 permanent employees engaged across various operational and business divisions. We are subject to a number of stringent labour laws that protect the interests of our workers, including legislation that stipulates rigorous procedures for dispute resolution and retrenchment of workers and imposes financial obligations on employers. While we have not experienced significant labour unrest in the past, strikes, lock-outs and other labour action, may have an impact on our operations, and if not resolved in a timely manner, could lead to disruptions in our operations. We cannot guarantee that we will not experience any strike, work stoppage or other industrial action in the future and any such event could affect our business, results of operation and financial condition. Additionally, our inability to recruit employees, in particular skilled employees and retain our current workforce could have a effect on our business, financial condition and profitability.

For further details of our employees, please refer to chapter titled “Our Business” beginning on page 91 of the Prospectus.

**32. *Our capacity installed at our manufacturing unit is not fully utilized.***

The capacity installed at our manufacturing unit is not fully utilized and is operating below installed capacity. The unutilisation of available capacity can affect our capacity to fully absorb fixed cost and thus may impact our financial performance. Our Unit – I is engaged in manufacturing of BRP, SSP and GSSP which is not utilizing the full capacity as installed in our factory and thereby increasing the per unit fixed cost. In addition to above our company has set up Unit – II for manufacturing of H-acid and other chemicals from September, 2016 which is also not utilizing the full capacity as installed. The unutilisation of installed capacity in future may affect profitability due to increase in per unit production fixed cost. For further details of installed capacity and utilization, please refer to chapter titled “Our Business” beginning on Page 91 of this Prospectus.

**33. *Our inability to effectively manage our growth or to successfully implement our business plan and growth strategy could have an effect on our business, results of operations and financial condition.***

The success of our business will depend greatly on our ability to effectively implement our business and growth strategy. Our growth strategy involves focusing on Optimal Utilization of Resources and to developed relationships with customer and suppliers. For further details, see the section titled “Our Business – Our Strategies” on page 91. Our success in implementing our growth strategies may be affected by:

- Our ability to identify new markets to expand;
- Our ability to maintain the quality of our products;
- Changes in the Indian regulatory environment in field of Fertilizer

There can be no assurance that we will be able to execute our strategy on time and within our estimated budget, or that our expansion and development plans will increase our profitability. Any of these factors could impact our results of operations. We cannot assure you that we will not face any time or cost overruns in respect of implementation of our strategies in the future. Further, we expect our growth strategy to place significant demands on our management, financial and other resources and require us to continue developing and improving our operational, financial and other internal controls. Our inability to manage our business and implement our growth strategy could have a effect on our business, financial condition and profitability.

**34. *Our business is subject to risks related to weather that could affect the results of our operations and our financial condition.***

Our business is mostly dependent upon the growth of agriculture and Agri-products which are subject to substantial risks faced by the weather condition in India. The agricultural industry is substantially subject to weather factors, which make its operational results relatively unpredictable. Weather condition such as delayed monsoon or less rainfall may affect us as a whole or on a regional basis. Due this fluctuation and unpredictability of the weather condition in India there can be no or less chances that we can meet the sale and demand forecast. Extreme weather conditions can potentially reduce the demand for our fertilizers in any year and have a effect on our business, results of operations and financial condition

**35. Conflicts of interest may arise out of common business objects between our Company, Corporate Promoters and Group Companies.**

Conflicts may arise in the ordinary course of decision-making by the Promoters or Board of Directors. Our Promoters have interests in other companies such as Ostwal Phoschem (India) Limited, Seasons Agro Chem (India) Pvt. Ltd., Madhya Bharat Agro Products Limited that undertake the same business as our Company. Our Group Companies and corporate Promoters are authorized to carry out, or engage in business similar to that of our Company. Conflicts of interests may arise in the Promoters' allocating or addressing business opportunities and strategies among our Company, our corporate Promoters and Group Companies in circumstances where our respective interests diverge. In cases of conflict, there can be no assurance that our Promoters will not favour their own interests over those of our Company. Our Promoters have not signed any non-compete agreement with our Company as of date. Any such present and future conflicts could have an effect on our business, reputation, financial condition and results of operations.

For further details, please refer section titled "Our Promoter and Promoter Group" and Our Group Companies" beginning on Page 139 & 148 of this Prospectus.

**36. Our Promoters/Directors and members of Promoter Group have provided personal guarantees for loan facilities obtained by our Company, and any failure or default by our Company to repay such loans in accordance with the terms and conditions of the financing documents could trigger repayment obligations on them, which may impact their ability to effectively service their obligations as our Promoters/Directors and thereby, impact our business and operations.**

Mr. Praveen Ostwal, our Promoter/ Director, Mr. Mahendra Kumar Ostwal, Mr. Pankaj Ostwal and Mrs. Ekta Jain, our Promoter Group Members, have personally guaranteed the repayment of loan facilities taken by us. As at November 30, 2016, outstanding amounts from credit facilities personally guaranteed was Rs. 2438.49 Lacs. Additionally, Mrs. Ekta Jain, our Promoter Group Member has provided personal property as collateral security to aforesaid loan facilities.

Any default or failure by us to repay its loans in a timely manner, or at all could trigger repayment obligations on the part of Mr. Praveen Ostwal, Mr. Mahendra Kumar Ostwal, Mr. Pankaj Ostwal and Mrs. Ekta Jain in respect of such loans, which in turn, could have an impact on their ability to effectively service their obligations as Promoters/Directors of our Company, thereby having an effect on our business, results of operation and financial condition. Furthermore, in the event that these individual withdraw or terminate their guarantees and collateral security, our lenders for such facilities may ask for alternate guarantees and collateral security, repayment of amounts outstanding under such facilities, or even terminate such facilities. We may not be successful in procuring guarantees satisfactory to the lenders, and as a result may need to repay outstanding amounts under such facilities or seek additional sources of capital, which could affect our financial condition and cash flows.

For further details, please refer to chapter titled "Statement of Financial Indebtedness" beginning on page 190 of the Prospectus.

**37. We have experienced negative cash flows in prior periods and any negative cash flows in the future could affect our financial condition.**

Our Company had reported certain negative cash flows from our investing activities and financing activities in the previous years as per the restated financial statements and the same are summarized as under:

Particulars	For the Period Ended on November 30, 2016	For the year ended March 31,				
		2016	2015	2014	2013	2012
Cash flow from Investing Activities	(1950.68)	(294.09)	(1063.54)	(541.98)	(1397.11)	(1702.96)
Cash flow from Financing Activities	1041.50	(488.01)	65.51	(987.42)	111.22	1522.38

Cash flow of a company is a key indicator to show the extent of cash generated from operations to meet capital expenditure, pay dividends, repay loans and make new investments without raising finance from external resources. If our Company is not able to generate sufficient cash flows, it may affect our business and financial operations. For further please refer chapter titled “Financial Information of the company” beginning on Page 157 of this Prospectus.

**38. Our Company have taken unsecured loans that may be recalled by the lenders at any time**

Our Company have currently availed unsecured loans which may be called by their lenders at any time. As on November 30, 2016, the unsecured loan amounting ₹ 505.39 Lacs were due to lenders. In the event that any lender seeks a repayment of any such loan, our company would need to find alternative sources of financing, which may not be available on commercially reasonable terms, or at all. If we are unable to procure such financing, we may not have adequate working capital to undertake our present activities or future plans. As a result, any such demand may affect our business, cash flows, financial condition and results of operations. Additionally our company has not executed any formal loan agreement of above unsecured loan, any dispute arises in relation to terms of loans may affect the loans by our company For further details on financing arrangements entered into by our Company, please refer chapter titled “Statement of Financial Indebtedness” beginning on page 190 of Prospectus.

**39. We have in the past entered into related party transactions and may continue to do so in the future, which may potentially involve conflicts of interest with the equity shareholders.**

We have in the course of our business entered into, and will continue to enter into, several transactions with our related parties. For details, see the section titled “Related Party Transactions” on page 185. We cannot assure you that we will receive similar terms in our related party transactions in the future. We cannot assure you that we could not have achieved more favorable terms had such transactions been entered into with unrelated parties. The transactions we have entered into and any further transactions with our related parties have involved or could potentially involve conflicts of interest which may be detrimental to our Company. Further, the Companies Act, 2013 has brought into effect significant changes to the Indian company law framework including specific compliance requirements such as obtaining prior approval from the audit committee, board of directors and shareholders for certain related party transactions. We cannot assure you that such transactions, individually or in the aggregate, will not have an effect on business and financial results, including because of potential conflicts of interest or otherwise.

**40. Our raw material Rock Phosphate is obtained from the mines; imposition of any restriction on the mining/extraction of such material from the mines could affect our operations and result of operations.**

Our major raw material Rock Phosphate is obtained from the mines situated in the close vicinity of our production unit. The imposition of any restriction on the mining of Rock Phosphate will compel us to search for other sources of raw material. Procurement of raw material from other sources could be more expensive and time consuming as we may not be able to secure the favorable terms and conditions as we are currently enjoying, and accordingly would adversely affect our revenues and profitability.

**41. Changes in technology may render our current technologies obsolete or require us to make substantial capital investments**

Our business depends on the continued performance of our information technology systems. Our technological systems are potentially vulnerable to physical or electronic break-ins, computer viruses and similar disruptions. Modernization and technology up gradation is essential to reduce costs and increase the output. Our manufacturing technology may become obsolete or may not be upgraded timely, hampering our operations and financial conditions and we may lose our competitive edge. Although we believe that we have installed upgraded technology suitable for BRP, SSP, GSSP and Intermediate dyes & other chemicals manufacturing and that the chances of a technological innovation are not very high in our sector we shall continue to strive to keep our technology updated. In case of a new found technology in the fertilizer manufacturing business, we may be required to implement new technology employed by us. Further, the cost in upgrading our technology is significant which could substantially affect our finances and operations. For further details, kindly refer section titled “Our Business” beginning on page no. 91 of this Prospectus.

**42. One of Group Company i.e. Madhya Bharat Agro Products Limited is listed on SME Platform of NSE (“NSE EMERGE”). Any non Compliance under applicable regulation will impact our Company and or Promoters.**

Our Group Company, Madhya Bharat Agro Products Limited came with an Initial Public offer in September, 2016 and listed on SME Platform of NSE (“NSE EMERGE”). As being listed company, various regulations of Securities and Exchange of Board of India is applicable on our Group Company and any non compliances under applicable regulation may lead to penalty and action

taken against our promoter and corporate Promoters which may impact their financial conditions and may divert the management attention which indirectly impact our Company.

For further details regarding shareholding of our Promoter and Promoter Group, please refer to chapter titled “Capital Structure” beginning on page 54 of the Prospectus.

**43. Information relating to our production capacities and the historical capacity utilization of our production facilities included in this Prospectus is based on certain assumptions and has been subjected to rounding off, and future production and capacity utilization may vary.**

Information relating to our production capacities and the historical capacity utilization of our production facilities included in this Prospectus is based on various assumptions and estimates of our management, including proposed operations, assumptions relating to availability and quality of raw materials, assumptions relating to operational efficiencies, as well as assumptions in relation to the average density of fertilizers manufactured by us. Actual production levels and utilization rates may differ significantly from the estimated production capacities or historical estimated capacity utilization information of our facilities. Undue reliance should therefore not be placed on our production capacity or historical estimated capacity utilization information for our existing facilities included in this Prospectus. For further information, see the section titled “Our Business” on page 91 of this Prospectus.

**44. A slowdown or shutdown in our manufacturing operations could have an adverse effect on our business, results of operations, financial condition and cash flows.**

Our business is dependent upon our ability to manage our manufacturing facilities, which are subject to various operating risks, including productivity of our workforce, compliance with regulatory requirements and those beyond our control, such as the breakdown and failure of equipment or industrial accidents and severe weather conditions and natural disasters. Any significant malfunction or breakdown of our machinery may entail significant repair and maintenance costs and cause delays in our operations. Our inability to effectively respond to any shutdown or slowdown and rectify any disruption, in a timely manner and at an acceptable cost, could lead to an inability to comply with our customers’ requirements and result in us breaching our contractual obligations. The occurrence of any such event could have an effect on our business, results of operations, financial condition and cash flows.

For further details regarding our manufacturing facilities, please refer section titled “Our Business” beginning on Page 91 of this Prospectus.

**45. The proceeds of the Offer will not be available to us.**

As of the date of this Prospectus, Our Selling Shareholders are selling total of 26.41% of the equity share capital of our Company in this proposed offer and has obtained approval for sale of such number of Equity Shares in the Offer for Sale pursuant to its Authorization letter/board resolution dated December 12, 2016. Additionally that the Offer comprises of the Offer for Sale by Selling Shareholders, the proceeds from the Offer will be remitted to the Selling Shareholders, and our Company will not benefit from such proceeds.

For further details regarding our offer terms, please refer section titled “Terms of the Offer” beginning on Page 244 of this Prospectus.

**46. Our Company has allotted Equity Shares during the preceding one year from the date of the Prospectus which may be lower than the Offer Price.**

Our Company has allotted the following Equity Shares during the preceding one year from the date of the Prospectus which may at price lower than the Offer Price under this Prospectus:

Date of Allotment	Name of the Allottees	Number of Shares	Face Value (₹)	Offer Price (₹)	Reasons
October 05, 2016	Ostwal Phoschem (India) Ltd. (Formerly Known as Tedco Granite Limited)	39,00,000	10	23.50	Preferential Allotment

For further details of the aforesaid allotment/s please refer “Capital Structure” on page no. 54 of this Prospectus.

**47. *The Offer Price of the Equity Shares may not be indicative of the market price of the Equity Shares after the Offer.***

The Offer Price of the Equity Shares will be determined by our Company and Selling Shareholders in consultation with the LM and will be based on numerous factors. For further information, see the section titled “Basis for Offer Price” on page 74 of this Prospectus. The Offer Price may not be indicative of the market price for the Equity Shares after the Offer. The market price of the Equity Shares could be subject to significant fluctuations after the Offer, and may decline below the Offer Price. There can be no assurances that Investors who are Allotted Equity Shares through the Offer will be able to resell their Equity Shares at or above the Offer Price.

**48. *There is no existing market for our Equity Shares, and we do not know if one will develop. The price of our Equity Shares may be volatile, and you may be unable to resell your Equity Shares at or above the Offer Price, or at all.***

Prior to the Offer, there has been no public market for our Equity Shares, and an active trading market on the Indian Stock Exchanges may not develop or be sustained after the Offer. The Offer Price of the Equity Shares may bear no relationship to the market price of the Equity Shares after the Offer. The market price of the Equity Shares after the Offer may be subject to significant fluctuations in response to, among other factors, variations in our operating results, market conditions and environment towards developments relating to India and volatility in the stock exchange and securities markets elsewhere in the world. Additionally, once listed, we will be subject to a daily “circuit breaker” imposed by stock exchanges in India, which does not allow transactions beyond specified increases or decreases in the price of the Equity Shares. As a result of this circuit breaker, no assurance may be given regarding your ability to sell your Equity Shares or the price at which you may be able to sell your Equity Shares at any particular time.

**49. *Our ability to pay dividends in the future will depend on our earnings, financial condition, working capital requirements, capital expenditures and restrictive covenants of our financing arrangements.***

Our ability to pay dividends in the future will depend on our earnings, financial condition, cash flow, working capital requirements, capital expenditure and restrictive covenants of our financing arrangements. Any future determination as to the declaration and payment of dividends will be at the discretion of our Board and will depend on factors that our Board deems relevant, including among others, our future earnings, financial condition, cash requirements, business prospects and any other financing arrangements. We cannot assure you that we will be able to pay dividends in the future. For details of dividend paid by our Company in the past, see “Dividend Policy” on page 156 of this Prospectus.

**50. *You may be subject to Indian taxes arising out of capital gains on the sale of our Equity Shares.***

Capital gains arising from the sale of our Equity Shares are generally taxable in India. Any gain realised on the sale of our Equity Shares on a stock exchange held for more than 12 months will not be subject to capital gains tax in India if the STT has been paid on the transaction. The STT will be levied on and collected by an Indian stock exchange on which our Equity Shares are sold. Any gain realised on the sale of our Equity Shares held for more than 12 months to an Indian resident, which are sold other than on a recognised stock exchange and as a result of which no STT has been paid, will be subject to a long-term capital gains tax in India. Further, any gain realised on the sale of our Equity Shares held for a period of 12 months or less will be subject to short-term capital gains tax in India. Capital gains arising from the sale of the Equity Shares will be exempt from taxation in India in cases where the exemption from taxation in India is provided under a treaty between India and the country of which the seller is resident. Generally, Indian tax treaties do not limit India’s ability to impose tax on capital gains. As a result, residents of other countries may be liable for tax in India as well as in their own jurisdiction on a gain upon the sale of the Equity Shares. For further details, see the section titled “Statement of Tax Benefits” on page 77 of this Prospectus.

**51. *You may be restricted in your ability to exercise pre-emptive rights under Indian law and may be adversely affected by future dilution of your ownership position.***

Under the Companies Act, a company incorporated in India must offer its shareholders pre-emptive rights to subscribe and pay for a proportionate number of shares to maintain their existing ownership percentages before the issuance of any new shares, unless the pre-emptive rights have been waived by adoption of a special resolution by holders of three-fourths of the shares who have voted on the resolution, or unless the company has obtained approval from the Government of India to issue without such special resolution, subject to votes being cast in favour of the proposal exceeding the votes cast against such proposal. However, if the law of the jurisdiction you are in does not permit you to exercise your pre-emptive rights without our Company filing an offering document or a registration statement with the applicable authority in the jurisdiction you are in, you will be unable to exercise your pre-emptive

rights unless our Company makes such a filing. To the extent that you are unable to exercise pre-emptive rights granted in respect of the Equity Shares, your proportional interest in our Company would be reduced.

**52. *Non-Institutional Investors are not permitted to withdraw or lower their Bids (in terms of quantity of Equity Shares or the Amount) at any stage after submitting an Application.***

Pursuant to the SEBI ICDR Regulations, Non-Institutional Investors are not permitted to withdraw or lower their Application (in terms of quantity of Equity Shares or the Amount) at any stage after submitting an Application. While our Company is required to complete Allotment pursuant to the Offer within six Working Days from the Offer Closing Date, events affecting the Applicants decision to invest in the Equity Shares, including material adverse changes in international or national monetary policy, financial, political or economic conditions, our business, results of operation or financial condition, may arise between the date of submission of the Application and Allotment. Our Company may complete the Allotment of the Equity Shares even if such events occur, and such events limit the applicant's ability to sell the Equity Shares Allotted pursuant to the Offer or cause the trading price of the Equity Shares to decline on listing.

**53. *Rights of shareholders under Indian law may be more limited than under the laws of other jurisdictions***

The articles of association, resolutions of the board of directors, and Indian law govern the corporate affairs of companies operating in India. Legal principles relating to these matters and the validity of corporate procedures, directors' fiduciary duties and liabilities, and shareholders' rights may differ from those that would apply to a company incorporated in another jurisdiction. Shareholders' rights under Indian law may not be as extensive as shareholders' rights under the laws of other countries or jurisdictions. Investors may have more difficulty in asserting their rights as our Company's shareholders than as shareholders of corporations in another jurisdiction.

## **EXTERNAL RISK FACTORS**

**54. *Political, economic or other factors that are beyond our control may have an adverse effect on our business, results of operations and cash flows.***

We currently manufacture only in India and are dependent on domestic, regional and market conditions. Our performance, growth and market price of our Equity Shares are and will be dependent on the agriculture of the Indian economy. There have been periods of slowdown in the economic growth of India. Demand for our products may be adversely affected by an economic downturn in domestic, regional and global economies. India's economic growth is affected by various factors including domestic consumption and savings, balance of trade movements, namely export demand and movements in key imports (oil and oil products), global economic uncertainty and liquidity crisis, volatility in exchange currency rates, and annual rainfall which affects agricultural production. Consequently, any future slowdown in the Indian economy could harm our business, results of operations, cash flows and financial condition. Also, a change in the Government or a change in the economic and deregulation policies could adversely affect economic conditions prevalent in the areas in which we operate in general and our business in particular and high rates of inflation in India could increase our costs without proportionately increasing our revenues, and as such decrease our operating margins.

**55. *We are not able to guarantee the accuracy of third party information.***

Market data and certain information and statistics relating to us and general market/industry data are derived from both public and private sources, including market research, publicly available information and industry publications. We have relied on various government publications and industry sources in the preparation of this Prospectus. Neither we, our directors nor our Promoter are in any way related to the parties that have prepared the relevant industry data on which we relied on. While we have taken reasonable care to ensure that the facts and statistics presented are accurately reproduced from such sources, they have not been independently verified by us and the LM, and therefore, we make no representation as to the accuracy, adequacy or completeness of such facts and statistics. Due to possibly flawed or ineffective calculation and collection methods and other problems, the facts and statistics herein may be inaccurate or may not be comparable to facts and statistics produced for other economies and should not be unduly relied upon. Further, there can be no assurance that the facts and statistics are stated or compiled on the same basis or with the same degree of accuracy as may be the case elsewhere.

**56. *Acts of terrorism and other similar threats to the economic, political and social stability of the countries we transact in, could adversely affect our business, financial condition, cash flows and results of operations.***



The countries where our Company operates have from time to time witnessed increased political instability, evidenced by the threat or occurrence of terrorist attacks, enhanced national security measures, conflicts in several regions in which we operate, military actions, civil unrests or other acts of violence or war. Any deterioration in international relations, especially between India and its neighboring countries, may result in investor concern regarding regional stability which could adversely affect the price of the Equity Shares. In addition, some of the recent instances of domestic unrest and political instability in India, would have a dire impact on the economy. Strained relations arising from these conflicts, the possibility of sanctions being imposed on the countries involved, downside risks and the related decline in consumer confidence shall always be entrenched and may hinder our ability to do business. Any escalation in these events or similar future events may disrupt our operations. Such acts could create a perception that investments in Indian companies involve greater degree of risk. The impact of such events on the volatility of global financial markets could increase the volatility of the market price of the Equity Shares and may limit the capital resources available to us.

***57. Companies in India are required to prepare financial statements under the new Indian Accounting Standards. In addition, all income-tax assessee in India will be required to follow the Income Computation and Disclosure Standards.***

The Ministry of Corporate Affairs (“MCA”), Government of India, has through notification dated February 16, 2015 issued the Indian Accounting Standards Rules, 2015 (“Ind AS”) which have come into effect from April 1, 2015 and are applicable to companies which fulfill certain conditions. Further, there can be no assurance that the adoption of Ind AS will not affect our reported results of operations or financial condition. Any of these factors relating to the use of Ind AS may adversely affect our financial condition and results of operations.

Further, the Ministry of Finance, Government of India has issued a notification dated September 29, 2016 notifying Income Computation and Disclosure Standards (“ICDS”), thereby creating a new framework for the 35 computation of taxable income. The ICDS shall apply from the assessment year 2017-2018 and subsequent years. The adoption of ICDS is expected to significantly alter the way companies compute their taxable income, as ICDS deviates from several concepts that are followed under general accounting standards, including Indian GAAP and Ind AS. In addition, ICDS shall be applicable for the computation of income for tax purposes but shall not be applicable for the computation of income for minimum alternate tax. There can be no assurance that the adoption of ICDS will not adversely affect our business, results of operations and financial condition.

***58. We may be affected by competition law in India and any adverse application or interpretation of the Competition Act could adversely affect our business.***

The Competition Act, 2002, as amended (the “Competition Act”), regulates practices having an appreciable adverse effect on competition in the relevant market in India. Under the Competition Act, any formal or informal arrangement, understanding or action in concert, which causes or is likely to cause an appreciable adverse effect on competition is considered void and may result in the imposition of substantial monetary penalties. Further, any agreement among competitors which directly or indirectly involves the determination of purchase or sale prices, limits or controls production, supply, markets, technical development, investment or provision of services in any manner, shares the market or source of production or provision of services by way of allocation of geographical area, type of goods or services or number of customers in the relevant market or in any other similar way, or directly or indirectly results in bid-rigging or collusive bidding is presumed to have an appreciable adverse effect on competition. The Competition Act also prohibits abuse of a dominant position by any enterprise. If it is proved that the contravention committed by a company took place with the consent or connivance of or is attributable to any neglect on the part of, any director, manager, secretary or other officer of such company, that person shall be guilty of the contravention and may be liable to punishment.

***59. Inflation in India could have an adverse effect on our profitability and if significant, on our financial condition.***

Inflation is typically impacted by factors such as governmental policies, regulations, commodity prices, liquidity and global economic environment. Any change in the government or a change in the economic and deregulation policies could adversely affect the inflation rates. Continued high rates of inflation may increase our costs such as salaries, travel costs and related allowances, which are typically linked to general price levels. There can be no assurance that we will be able to pass on any additional costs to our clients or that our revenue will increase proportionately corresponding to such inflation. Accordingly, high rates of inflation in India could have an adverse effect on our profitability and, if significant, on our financial condition.

***60. The nationalized goods and service tax (GST) regimes proposed by the Government of India may have material impact on our operations.***

The Government of India has proposed a comprehensive national goods and service tax (GST) regime that will combine taxes and levies by the Central and State Governments into a unified rate structure. GST is hoped to remove the cascading effect of various taxes and simplify the existing tax system. GST has special significance for the fertilizer sector which is currently allowed a number of tax concessions/exemptions both at input and output levels and there is also heavy subsidy on sale of fertilizers. The impact on fertilizer industry will depend on how these elements are treated under the proposed GST regime. Further amendments and developments shall have material effect on our operations.

**61. *The recent currency demonetization measures imposed by the Government of India may adversely affect the India Economy and our business.***

Through notifications dated November 8, 2016 issued by the Ministry of Finance, GoI and the RBI ₹ 500 and ₹ 1,000 denominations of bank notes of then existing series issued by the RBI have ceased to be legal tender. Pursuant to this currency demonetisation, these high denomination notes have no value and cannot be used for transactions or exchange purposes with effect from November 9, 2016. These notes are currently being replaced with a new series of bank notes. In an effort to monitor replacement of demonetised notes, the GoI has specified restrictive limits for exchange and withdrawal of currency all over India. The process of demonetisation and replacement of these high denomination notes is likely to reduce the liquidity in the Indian economy which has significant reliance on cash. These factors may result in reduction of purchasing power, and alteration in consumption patterns of the economy in general. While the comprehensive and long-term impact of this currency demonetisation measure cannot be ascertained at the moment, it is possible that there will be a slowdown in the economic activities in India as expressed by various experts, at least in the short term, given the demonetization impacts a majority quantity of the cash currency in circulation. Such a slowdown can adversely affect the Indian economy, impacting the consumer sector, in turn affecting the operations of our company, which can affect their financials and profitability.

**62. *Our business is dependent on the Indian economy.***

The performance and growth of our business are necessarily dependent on economic conditions prevalent in India, which may be materially and adversely affected by center or state political instability or regional conflicts, a general rise in interest rates, inflation, and economic slowdown elsewhere in the world or otherwise.

There have been periods of slowdown in the economic growth of India. India's economic growth is affected by various factors including domestic consumption and savings, balance of trade movements, namely export demand and movements in key imports (oil and oil products), global economic uncertainty and liquidity crisis, volatility in exchange currency rates and annual rainfall which affects agricultural production. Any continued or future slowdown in the Indian economy or a further increase in inflation could have a material adverse effect on the price of our raw materials and demand for our products and, as a result, on our business and financial results.

The Indian financial market and the Indian economy are influenced by economic and market conditions in other countries, particularly in emerging market in Asian countries. Financial turmoil in Asia, Europe, the U.S. and elsewhere in the world in recent years has affected the Indian economy. Although economic conditions are different in each country, investors' reactions to developments in one country can have adverse effects on the securities of companies in other countries, including India. A loss in investor confidence in the financial systems of other emerging markets may cause increased volatility in Indian financial markets and, indirectly, in the Indian economy in general. Any worldwide financial instability, including the financial crisis and fluctuations in the stock markets in China and further deterioration of credit conditions in the U.S. or European markets, could also have a negative impact on the Indian economy. Financial disruptions may occur again and could harm our business and financial results.

**63. *Investors may be affected due to retrospective tax law changes made by the GoI affecting us.***

Certain recent changes to the Income Tax Act provide that income arising directly or indirectly through the sale of a capital asset of an offshore company, including shares, will be subject to tax in India, if such shares derive indirectly or directly their value substantially from assets located in India. The term "substantially" has not been defined under the Income Tax Act and therefore, the applicability and implications of these changes are largely unclear. Due to these recent changes, investors may be subject to Indian income taxes on the income arising directly or indirectly through the sale of the Equity Shares. In the past, there have been instances where changes in the Income Tax Act have been made retrospectively and to that extent, there cannot be an assurance that such retrospective changes will not happen again.

**Prominent Notes:**

1. Public Offer of 65,76,000 Equity Shares of Face Value of ₹ 10/- each of Krishana Phoschem Limited (“KPL” or “Our Company”) for Cash at a Price of ₹ 30.00 Per Equity Share (Including a Share Premium of ₹ 20.00 per Equity Share) (“Offer Price”) aggregating to ₹ 1972.80 Lakhs, of which 3,36,000 Equity Shares of Face Value of ₹ 10/- each at a price of ₹ 30.00 aggregating to ₹ 100.80 Lacs will be reserved for subscription by Market Maker (“Market Maker Reservation Portion”) and Net Offer to Public of 62,40,000 Equity Shares of Face Value of Rs. 10/- each at a price of ₹ 30.00 aggregating to ₹ 1872.00 Lakhs (hereinafter referred to as the “Net Offer”) The Offer and the Net Offer will constitute 26.41% and 25.06% respectively of the Post Offer paid up Equity Share Capital of Our Company.
2. This Offer is being made for at least 25 % of the post- offer paid-up Equity Share capital of our Company, pursuant to Rule 19(2) (b) (i) of the Securities Contracts (Regulation) Rules, 1957 as amended. This Offer is being made in terms of Chapter XB of the SEBI (ICDR) Regulations, 2009, as amended from time to time. As per Regulation 43(4) of the SEBI (ICDR) Regulations, as amended, since our is a fixed price offer ‘the allocation’ is the net offer to the public category shall be made as follows:
  - a) Minimum fifty percent to retail individual investors; and
  - b) Remaining to
    - (i) Individual applicants other than retail individual investors; and
    - (ii) Other investors including corporate bodies or institutions, irrespective of the number of specified securities applied for
  - c) The unsubscribed portion in either of the categories specified in (a) or (b) above may be allocated to the applicants in the other category.

*If the retail individual investor category is entitled to more than fifty per cent on proportionate basis, accordingly the retail individual investors shall be allocated that higher percentage.*

3. The Net worth (excluding Revaluation Reserve) of our Company as on November 30, 2016 March 31, 2016 and March 31, 2015 was Rs. 5771.84 Lakh Rs. 4462.96 Lakh and Rs. 4147.65 Lakh respectively based on Restated Financial Statements. For more information, see the section titled “Financial Information of the Company” beginning on page 157 of this Prospectus.
4. The NAV / Book Value per Equity Share, based on Restated Financials Statements as on November 30, 2016, March 31, 2016 and March 31, 2015 was Rs. 23.18/-, Rs. 21.25/- and Rs. 19.75/- per equity share respectively based on Restated Financial Statements. For more information, see the section titled “Financial Information of the Company” beginning on page 157 of this Prospectus.
5. The average cost of acquisition of Equity Shares by our Promoters is set out below:

Name of our Promoters	Number of Equity Shares Held	Average Cost of Acquisitions (Rs)
Mr. Praveen Ostwal	6,78,500	9.69
Ostwal Phoschem (India) Limited	97,66,500	21.83
Seasons Agro Chem India Pvt. Ltd.	23,87,500	4.40

For further details, please see the section entitled “Capital Structure” on page 54 of this Prospectus.

6. The details of transactions of our Company with related parties, nature of transactions and the cumulative value of transactions please refer to section titled “Financial Information of the Company - Annexure Q –Statement of Related Parties Transactions, on page 185 of Prospectus.
7. No Group companies have any business or other interest in our Company, except as stated in section titled “Financial Information of the Company - Annexure Q - Statement of Related Parties Transactions, as Restated” on page 185 and “Our Group Companies” on page 148 and to the extent of any Equity Shares held by them and to the extent of the benefits arising out of such shareholding.
8. Our Company was originally incorporated on May 14, 2004 as “Krishana Phoschem Limited” vide Registration no. 17-019288/2004-2005 (CIN: U24124RJ2004PLC019288) under the provisions of the Companies Act, 1956 with the Registrar of Companies, Rajasthan, Jaipur.  
For further details, please refer to Section titled “History and Certain Corporate Matters” on page 122 of this Prospectus.

9. None of our Promoters, Promoter Group, Directors and their relatives has entered into any financing arrangement or financed the purchase of the Equity Shares of our Company by any other person during the period of six months immediately preceding the date of filing of Prospectus.
10. Investors are advised to see the paragraph titled “Basis for Offer Price” beginning on page 74 of this Prospectus.
11. The Lead Manager, our Company and the Selling Shareholders shall update this Prospectus and keep the investors / public informed of any material changes till listing of the Equity Shares offered in terms of this Prospectus and commencement of trading.
12. Investors are free to contact the Lead Manager i.e. Hem Securities Limited for any clarification, complaint or information pertaining to the Offer. The Lead Manager and our Company shall make all information available to the public and investors at large and no selective or additional information would be made available for a section of the investors in any manner whatsoever.
13. In the event of over-subscription, allotment shall be made as set out in paragraph titled “Basis of Allotment” beginning on page 283 of this Prospectus and shall be made in consultation with the Designated Stock Exchange i.e. NSE. The Registrar to the Offer shall be responsible to ensure that the basis of allotment is finalized in a fair and proper manner as set out therein.
14. The Directors / Promoters of our Company have no interest in our Company except to the extent of remuneration and reimbursement of expenses (if applicable) and to the extent of any Equity Shares of our Company held by them or their relatives and associates or held by the companies, firms and trusts in which they are interested as director, member, partner, and/or trustee, and to the extent of benefits arising out of such shareholding. For further details please see the chapter titled “Our Management” beginning at page 127 chapter titled “Our Promoter & Promoter Group” beginning at page 139, and chapter titled “Financial Information of the Company” beginning at page 157 of this Prospectus.
15. No loans and advances have been made to any person(s) / companies in which Directors are interested except as stated in the Auditors Report. For details, please see “Financial Information of the Company” beginning on page 157 of this Prospectus.

## SECTION III – INTRODUCTION

### SUMMARY OF OUR INDUSTRY

#### **Global economic outlook**

The World Bank is revising its 2016 global economic growth forecast down to 2.4 percent from the 2.9 percent pace projected in January. The move is due to sluggish growth in advanced economies, stubbornly low commodity prices, weak global trade, and diminishing capital flows. Commodity-exporting emerging market and developing economies have struggled to adapt to lower prices for oil and other key commodities. Growth in these economies is projected to advance at a meager 0.4 percent pace this year, whereas growth in commodity importers has been more resilient. Projections are subject to substantial downside risks, including additional growth disappointments in advanced economies or key emerging markets and rising policy and geopolitical uncertainties. In an environment of weak growth and eroding policy buffers, structural reforms have become even more urgent. “Depressed commodity prices have slowed growth sharply in commodity-exporting emerging and developing economies, which are home to more than half the global poor,” said World Bank Group President Jim Yong Kim, “Economic growth remains the most important driver of poverty reduction. This underscores the critical priority of pursuing growth-enhancing policies to eliminate extreme poverty and boost shared prosperity.”

(Source: - <https://www.worldbank.org/en/publication/global-economic-prospects/>)

#### **Recent Developments: Emerging market and developing economies**

The weakness in emerging market and developing economies in 2015 has extended into 2016. Aggregate growth for EMDEs is projected at 3.5 percent for 2016, marginally above the disappointing pace of 3.4 percent in 2015. However, this forecast masks a marked difference between commodity exporters and importers. After stagnating last year, growth in commodity exporting EMDEs for 2016 is expected to be 0.4 percent—substantially below the 1.6 percent envisaged in January, reflecting further downward revisions to commodity price forecasts, weak global trade, volatile capital flows, and persistent domestic challenges. In contrast, growth projections for commodity importing EMDEs are little changed, at 5.8 percent for 2016, and are expected to be broadly stable at that level through 2018. In low-income countries, growth in 2016 is projected at 5.3 percent. Policy buffers continue to erode in commodity exporting EMDEs, especially in oil exporting countries, reducing their ability to withstand further downside shocks.

#### **Indian Economy Overview**

India is the world’s fastest-growing large economy, having outpaced China over the past year. Yet though economic growth has improved living standards, India, which has the largest number of poor in the world, is still struggling to lift its 1.2 billion population out of poverty. The IMF predicts a robust growth rate of 7.6% for India’s economy in 2016 and 2017.

"India has benefited from lower oil prices and remains the fastest-growing large economy in the world," the IMF said.

However, concerns remain about jobs, which have not kept pace with economic growth. India now ranks 39th among the world’s most competitive economies, up 16 places from last year – the biggest leap for any country in the World Economic Forum’s Global Competitiveness Report 2016-2017.

(Source: <https://www.weforum.org/agenda/2016/10/india-economy-in-numbers/>)

Economic growth is projected to remain strong, hovering around 7.5%. Private consumption will be boosted by expected large increases in public wages and declining inflation. Investment will pick up gradually as excess capacity fades, deleveraging continues for corporations and banks, and infrastructure projects mature.

Inflation is above the long-term target and public debt is high, leaving little room for accommodative policies. However, some monetary impulse is to come as recent cuts in policy rates are passed on to consumers and investors. The renewed commitment for fiscal consolidation is welcome but the quality of public finances should be improved by increasing tax revenue and tilting the spending mix towards physical and social infrastructure. Creating more and better quality jobs is the key to inclusive growth and requires modernizing labour laws and making further progress in the ease of doing business.

Improving productivity is essential for India’s GDP per capita to catch up with higher-income countries. In the agriculture sector, which still absorbs about half of total employment, this would require farm consolidation and mechanization as well as better storage and transport infrastructure. In the manufacturing sector, labour and product market regulations should be reformed to enable firms to expand to an efficient size. Providing better access to quality health and education systems is also key, both to raise productivity and to ensure its fruits are spread more equitably.

### Recent Developments:-

The Indian economy will continue to post robust growth in the coming years, says the latest India Development Update of the World Bank. The Update also reviews the current challenges in India's financial sector and analyzes some of the impacts of the recommendations of the 14<sup>th</sup> Finance Commission on Indian states.

According to the Update, India's economy expanded at a faster pace in financial year (FY) 2016 even as a number of its growth engines stalled. Agriculture – having faced two consecutive drought years – rural household consumption, private investments, and exports have not performed to potential. The oil bonanza most directly benefited the government, which for the first time in five years exceeded its revenue collection targets and used the resources to contain the fiscal deficit, transfer more resources to states, and spend more on infrastructure. Capital spending by the central government was ramped up, its efforts amplified by state governments that had additional resources from larger fiscal devolution.

But it was urban households who were the main drivers of growth in FY 2016. The manufacturing and services sectors, which expanded 7.4 and 8.9 percent, respectively, also created urban jobs. Inflation abated, primarily because of lower food prices. Lower inflation raised real incomes, and allowed RBI to cut interest rates, which favored the financially-connected urban households.

To remain on this growth path and sustain growth at 7.6 percent into FY17, the challenge for the Indian economy is to activate the stalled engines – agricultural growth and rural demand; trade; and private investment, while ensuring that demand from urban households and public investments.

(Source: <http://www.worldbank.org/en/news/press-release/2016/06/20/manufacturing-and-services-urban-consumption-keep-economy-on-growth-path>)

### INDIAN AGRICULTURE INDUSTRY

Agriculture plays a vital role in India's economy. Over 58 per cent of the rural households depend on agriculture as their principal means of livelihood. Agriculture, along with fisheries and forestry, is one of the largest contributors to the Gross Domestic Product (GDP).

As per estimates by the Central Statistics Office (CSO), the share of agriculture and allied sectors (including agriculture, livestock, forestry and fishery) was 15.35 per cent of the Gross Value Added (GVA) during 2015-16 at 2011-12 prices.

India is the largest producer, consumer and exporter of spices and spice products. India's fruit production has grown faster than vegetables, making it the second largest fruit producer in the world. India's horticulture output, comprising fruits, vegetables and spices, is estimated to be 283.4 million tonnes (MT) in 2015-16 after the third advanced estimate. It ranks third in farm and agriculture outputs. Agricultural export constitutes 10 per cent of the country's exports and is the fourth-largest exported principal commodity. The agro industry in India is divided into several sub segments such as canned, dairy, processed, frozen food to fisheries, meat, poultry, and food grains.

The Department of Agriculture and Cooperation under the Ministry of Agriculture is responsible for the development of the agriculture sector in India. It manages several other bodies, such as the National Dairy Development Board (NDDB), to develop other allied agricultural sectors.

(Source: <http://indiainbusiness.nic.in/newdesign/index.php?param=advantage/165>)

### WORLD AGRICULTURE

Agricultural development is one of the most powerful tools to end extreme poverty, boost shared prosperity and feed 9 billion people by 2050. Growth in the agriculture sector is about two to four times more effective in raising incomes among the poorest compared to other sectors. This is important for 78 percent of the world's poor who live in rural areas and depend largely on farming to make a living.

But agriculture-driven growth and poverty reduction, as well as food security are at risk: A warming climate could cut crop yields by more than 25 percent. Agriculture and land use change are also responsible for between 19–29 percent of global greenhouse gas emissions. Mitigation in the agriculture sector is part of the solution to climate change.

(Source: <http://www.worldbank.org/en/topic/agriculture/overview>)

### FERTILIZER INDUSTRY

**Fertilizer Demand:** Following a drop in 2015/16, world fertilizer demand is anticipated to recover in 2016/17

In response to the economic slowdown in many emerging and developing countries, persistent low international prices for most agricultural commodities, and dry conditions across South Asia, Southeast Asia, Latin America and Africa, world fertilizer demand is expected to contract by 1.0% in 2015/16, to 181 million tonnes (Mt) nutrients. Aggregate demand in 2015/16 is anticipated to rebound in the three regions where it contracted in 2014/15: Eastern Europe & Central Asia (EECA), West Asia and North America. Demand is seen as dropping elsewhere

The outlook for 2016/17 is more optimistic in view of slightly improving market conditions, the expected more favorable weather, and a better political and economic situation in some sizable markets. Global fertilizer demand in 2016/17 is seen as rebounding (+2.9%) to 186 Mt, with growth rates of relatively similar magnitude for all three nutrients.

Demand in developed countries is anticipated to rise marginally, with stronger prospects in Oceania. With N and P demand in China levelling off, about half the world market can be considered 'mature'. In volume terms, South Asia, East Asia and Latin America would account for 33%, 22% and 22%, respectively, of the global increase in total fertilizer demand anticipated in the next five years.

**Fertilizer Supply:** 2015 was characterized by near-stagnant fertilizer demand. Production capacity and supply availability have both been increasing. Entering 2016, the fertilizer industry continues to face overcapacity conditions and market pressures caused by bearish fertilizer demand and intensified supply competition. Rationalization and consolidation activities have begun in key producing countries. Several producers recently embarked on cost reduction and operational efficiency programmes.

Large integrated producing groups are proceeding to a re-segmentation of activities in order to further engage in the high added-value specialty fertilizer segment.

Between 2016 and 2020 the fertilizer industry will invest close to US\$130 billion in more than 150 new production units, increasing global capacity by over 150 million tonnes products.

(Source - <http://www.fertilizer.org/>- Fertilizer Outlook 2016-2020)

## SUMMARY OF OUR BUSINESS

The following information should be read together with, the more detailed financial and other information included in this Prospectus, including the information contained in “Risk Factors”, “Management’s Discussion and Analysis of Financial Condition and Results of Operations” and “Financial Information of the Company” on page 16, 192 & 157 respectively

### OVERVIEW

Incorporated in 2004, we are primarily engaged in manufacturing of fertilizers, intermediate dyes and other allied chemical products in the state of Madhya Pradesh. We are manufacturers of Benefited Rock Phosphate (BRP), Single Super Phosphate (SSP), Granulated Single Super Phosphate (GSSP), H-Acid, intermediate dyes and other allied chemicals. Our products Single Super Phosphate (SSP) and Granulated Single Super Phosphate (GSSP) is used in replenishing “P” (Phosphorous) in the soil and act as a fertilizer for crop. Initially our company was engaged in manufacturing of BRP and further expanded to forward integration in manufacturing of SSP and GSSP and expanding for Diversification in intermediate dyes and other allied chemicals.

Our Company manufacture specialized chemicals used for dyeing cloth such as H acid, E K acid, Vinyl sulphone, PNCBOSA, 4 sulphoantranilic acid, Violet acid, Sulpho Tobias acid. The chemicals produce by our company is used as Dye intermediate specifically for textiles Industry.

Our manufacturing facilities are located near the Jhabua, Meghnagar District (M.P), and distributed in two units, viz:

- Unit - I located at 115-120 & 126-133, A.K.V.N. Industrial Area, Meghnagar, Jhabua, Madhya Pradesh installed with production capacity of 200000 MT of Beneficiated Rock Phosphate (BRP), 120000 MT of Single Super Phosphate (SSP) and 90000 MT of Granulated Single Super Phosphate (GSSP).
- Unit - II located at 142 & 143, AKVN Industrial Area, Meghnagar, Jhabua, Madhya Pradesh with installed capacity of acids and other chemicals such as E K Acid, H Acid, H-ACID (By Production from E K Acid), PNCBOSA, Sulpho Anthranilic Acid, Sulpho tobias Acid (STA), Vinyl Sulphone and Violet Acid.

In Addition to above, our company is in process for installation of Unit - III located at 126 A & 134, AKVN Industrial Area, Meghnagar, Jhabua, Madhya Pradesh for manufacturing of sulphuric acid, Chloro sulphonic Acid, Liquid SO<sub>3</sub> and other allied chemicals. Sulphuric acid is a highly corrosive strong mineral acidulfuric acid has a wide range of applications including in domestic acidic drain cleaners, as an electrolyte in lead-acid batteries and in various cleaning agents. It is also a central substance in the chemical industry.

We are an ISO 9001:2008 certified company for manufacturing & supply of Benefited Rock Phosphate (BRP), Single Super Phosphate (SSP) and Granulated Single Super Phosphate (GSSP). Our manufacturing facilities are well equipped with required facilities including machinery, Feed Hopper, Conveyor Belt, Crusher and other handling equipments to facilitate smooth manufacturing process.

### Features of our Products

- ❖ Highest Demanded Fertilizer, because of its Low price per kg it is preferred by small and marginal farmers and can be blended with other fertiliser products (except Urea & DAP)
- ❖ Readily accepted by the crops as SSP comprises of 14.50% water soluble phosphate and the ratio of phosphorus and sulphur suits many crop and pasture needs.
- ❖ Only Phosphatic fertilizer which can utilize Indian rock phosphate deposits
- ❖ Can be stored easily for long periods, without taking up moisture.

### Certifications & Recognitions:

The high quality and consistency of our products has won the confidence of our customer. Some of the prominent certifications and recognitions received by our Company are the following:-

- ❖ **ISO 9001:2008** certification for manufacturing & Supply of Beneficiated Rock Phosphate (BRP), Single Super Phosphate (SSP) and Granulated Single Super Phosphate (GSSP). The certificate is in recognition of the Company’s Quality Management System and is valid till January 17, 2017



- ❖ Our Company has consecutively got Commendation certificate for best Taxpayer from Madhya Pradesh Commercial Department for all the financial years from 2007-08 to 2011-12.

### **OUR BUSINESS STRENGTH:-**

#### **1. Cost Effective sourcing and Strategic Location of Manufacturing Unit:-**

We believe that our cost efficient manufacturing and supply chain management results in a significant reduction in our operational costs. With our experience, we are able to gauge our procurement of raw materials in timely manner. Further, our manufacturing units, situated within the state of Madhya Pradesh are ensured with sufficient raw material which is locally procured. The location of our current manufacturing facilities gives us a significant competitive cost advantage in terms of raw material sourcing manufacturing and labour costs and enables us to address the western markets efficiently.

#### **2. Quality assurance**

Our Company has a testing division and an in house laboratory which is responsible for the final approval of product manufactured. The final product manufactured has to undergo a quality check before it is finally packed and dispatch. We also have quality control checks before any consignment of Raw material is accepted since it has a direct impact on the quality of Finished Product. Our Quality assurance has enabled us provide satisfactory performance to our Customer.

#### **3. Leveraging the expertise of our Promoters and Management Team:-**

Our Promoters are engaged in Mineral beneficiation plant and Fertilizer Industries, which also form part of Board of Directors of our Company. Also, our Company is managed by a team of professional & experienced personnel. The team comprises of personnel having operational and business development experience. We believe that our management team's experience and their understanding of the industry will enable us to continue to take advantage of both current and future market opportunities. It is also expected to help us in addressing and mitigating various risks inherent in our business, including significant competition and the global economic crisis.

#### **4. Forward integration and Diversification:-**

Initially our company was engaged in manufacturing of Beneficiated Rock Phosphate (BRP) in Unit – I with installed capacity of 2,00,000 MT. As a step towards forward integration our Company has set up a manufacturing facilities for production of Single Super Phosphate (SSP) with an installed processing capacity of 1,20,000 MT in the year 2012-13 and production of Granulated Single Super Phosphate (GSSP) with an installed processing capacity of 90,000 MT in the year 2013-14 at Unit –I situated at 115-120 & 126-133 A.K.V.N Industrial area, Meghnagar, Jhabua (M.P.), Madhya Pradesh. Furthermore we have diversified our business into manufacturing of intermediate dyes and other allied chemicals in our Unit II situated at Meghnagar, Jhabua, Madhya Pradesh.

#### **5. Existing relationship with suppliers:-**

We buy low grade rock from Madhya Pradesh State Mines and Minerals Limited and sulphuric acid from Hindustan Zinc Limited and B Roshan Lal & Chemicals Private Limited etc. We had also entered into a Memorandum of Understanding dated September 02, 2004 with Madhya Pradesh State Mining Corporation for purchase of low-grade rock for a period of 10 years. Based on our relationship with supplier, we are still procuring our raw material i.e. Rock Phosphate from MPSMC. Also we have acquired other raw materials from several suppliers and have maintained relationship with them for a long time. Due to our relationships with our suppliers, we get quality and timely supplies of raw materials. This enables us to manage our inventories and supply quality products.

### **OUR BUSINESS STRATEGIES:-**

#### **1. Optimal Utilization of Resources:-**

Our Company constantly endeavors to improve our manufacturing process, and will increase service activities to optimize the utilization of resources. We have invested significant resources, and intend to further invest in our activities to develop customized systems and processes to ensure effective management control. We regularly analyze our existing policies to be carried out for our manufacturing process which enables us to identify the areas of bottlenecks and correct the same. This helps us in improving efficiency and putting resources to optimal use.

## **2. Continue to invest significantly in R&D:-**

We intend to increase our initiatives in R & D in order to constantly study industry verticals to identify product inefficiencies in areas in which we could add value. Going forward, we intend to expand our research and development capabilities, by increasing our investment in employing qualified individuals from the industry thereby augmenting our dedicated in-house R&D team. We believe that continued investments in R&D will enable us to increase our productivity, improve our operating efficiency, and enable us to penetrate existing and new market segments.

## **3. To build-up a professional organization:-**

As an organization, we believe in transparency and commitment in our work and with our customers. We have an experienced team for taking care of our day to day operations. We also consult with external agencies on a case to case basis on technical and financial aspects of our business. We will consistently put efforts among its group of experienced employees to transform them into an outstanding team of empowered professionals which helps in further accelerating the wheels of development of the Organization.

## **4. Develop and maintain relationships with our Suppliers and Customers:-**

We believe in maintaining good relationship with our Suppliers and Customers which is the most important factor to keep our Company growing. Our dedicated and focused approach and efficient and timely delivery of products has helped us build strong relationships over a number of years. We bag and place repetitive order with our customers as well as with our suppliers. For us, establishing strong, mutually beneficial long-term relationships with strategic supplier relationship management is a critical step in improving performance across the supply chain, generating greater cost efficiency and enabling the business to grow and develop.

## **5. Broaden and Deepen Our Geographical Presence**

We intend to deepen market penetration and increase our market share for existing products, as well as to position ourselves to successfully commercialize our products under development and any additional products for which we may receive approval. We may either form important relationships with companies with strong local presence through whom we can undertake our own sales and marketing.

**SUMMARY OF OUR FINANCIALS****ANNEXURE –I****RESTATED STATEMENT OF ASSETS AND LIABILITIES**

(Amt in Lacs.)

Particulars	As at					
	11/30/2016	3/31/2016	3/31/2015	3/31/2014	3/31/2013	3/31/2012
<b>I. EQUITY AND LIABILITIES</b>						
<b>Shareholder's Funds</b>						
Share Capital	2,490.00	2,100.00	2,100.00	1,800.00	1,800.00	1,800.00
Reserves and Surplus (including Revaluation Reserves, if any)	6,229.52	5,395.25	5,215.36	4,757.00	2,284.23	1,890.74
Money received against share warrants	-	-	-	-	-	-
<b>Share Application Money Pending Allotment</b>	-	-	-	-	-	-
<b>Non Current Liabilities</b>						
Long-term Borrowings	1,508.79	1,261.76	1,276.81	1,264.36	1,812.47	1,506.70
Deferred tax liabilities (Net)	444.18	367.23	274.19	156.14	51.58	112.38
Other Long Term Liabilities	-	-	-	-	-	-
Long-term Provisions	-	-	-	-	-	-
<b>Current Liabilities</b>						
Short-term Borrowings	1,284.16	1,658.97	1,690.01	1,652.20	1,160.80	163.09
Trade Payables	722.53	318.27	1,227.61	1,042.30	681.32	212.05
Other Current Liabilities	197.41	344.27	293.44	410.13	187.89	169.74
Short-term Provisions	116.04	126.38	113.67	152.37	154.74	147.47
<b>Total</b>	<b>12,992.64</b>	<b>11,572.12</b>	<b>12,191.09</b>	<b>11,234.50</b>	<b>8,133.03</b>	<b>6,002.17</b>
<b>II. ASSETS</b>						
<b>Non Current Assets</b>						
Fixed assets						
(i) Tangible Assets	8,028.08	7,080.56	7,173.67	7,374.07	4,289.31	2,873.72
(ii) Intangible Assets	0.73	0.10	0.17	0.27	0.41	0.17
(iii) Capital Work-In-Progress	1,487.81	810.72	862.67	19.80	905.32	1,507.92
(iv) Intangible Assets Under Development	-	-	-	-	-	-
Non Current Investments						
Deferred Tax Assets (Net)	-	-	-	-	-	-
Long-term Loans and Advances	61.06	58.67	101.19	145.85	172.24	40.72
Other Non Current Assets	-	-	-	-	-	-
<b>Current Assets</b>						
Current Investments						
Inventories	2,220.88	1,527.86	3,109.40	3,248.98	1,851.60	486.89
Trade Receivables	640.18	1,499.72	480.82	196.66	573.38	796.40
Cash and Cash Equivalents	15.57	6.09	15.31	8.74	5.35	28.83
Short-term Loans and Advances	536.89	579.00	445.98	238.38	334.75	267.37
Other Current Assets	1.44	9.40	1.89	1.74	0.67	0.16
<b>Total</b>	<b>12,992.64</b>	<b>11,572.12</b>	<b>12,191.09</b>	<b>11,234.50</b>	<b>8,133.03</b>	<b>6,002.17</b>

Note:- The above statement should be read with the significant accounting policies and notes to restated summary, profits and losses and cash flows appearing in Annexure IV, II and III.

**ANNEXURE – II****RESTATED STATEMENT OF PROFIT AND LOSS**

(Amt in Lacs.)

Particulars		For the	For the Year ended				
		Period Ended	3/31/2016	3/31/2015	3/31/2014	3/31/2013	3/31/2012
Revenue from Operations		4,463.52	8,907.44	7,280.83	9,040.40	4,022.04	2,527.25
Other Incomes		56.12	155.23	444.99	43.30	165.16	166.03
<b>Total Revenue</b>	<b>A</b>	<b>4,519.64</b>	<b>9,062.67</b>	<b>7,725.82</b>	<b>9,083.70</b>	<b>4,187.20</b>	<b>2,693.28</b>
Expenses:							
Cost of Material Consumed		2,972.93	4,202.91	4,357.67	6,263.87	2,101.88	1,046.38
Employee Benefits Expenses		70.59	173.44	160.44	171.33	162.31	190.09
Administrative and other Expenses		1,019.28	1,831.59	2,245.12	2,045.86	1,709.39	911.01
Finance Costs		122.03	472.96	546.94	439.31	194.55	87.51
Depreciation And Amortization Expense		239.30	352.40	342.48	352.95	216.27	132.13
Changes in inventories		(487.78)	1,523.18	(444.09)	(944.93)	(954.38)	(185.19)
<b>Total Expenses</b>	<b>B</b>	<b>3,936.34</b>	<b>8,556.48</b>	<b>7,208.56</b>	<b>8,328.38</b>	<b>3,430.02</b>	<b>2,181.93</b>
Profit before exceptional and extraordinary items and tax (A-B)	<b>C</b>	583.30	506.19	517.26	755.32	757.18	511.35
Exceptional/Prior Period item		-	-	-	-	-	-
Profit before extraordinary items and tax		583.30	506.19	517.26	755.32	757.18	511.35
Extraordinary item		-	-	-	-	-	-
Profit Before Tax		<b>583.30</b>	<b>506.19</b>	<b>517.26</b>	<b>755.32</b>	<b>757.18</b>	<b>511.35</b>
Provision for Tax							
- Current Tax		115.42	107.34	101.69	150.18	149.56	146.49
- Deferred Tax Liability / (Asset)		76.96	93.04	118.04	104.56	(60.79)	13.76
MAT Credit Entitlement		-	-	-	-	-	-
Short/(Excess) Tax adjustment of prior years		(1.47)	(9.49)	4.74	(3.96)	32.58	7.23
<b>Restated profit after tax for the period from continuing operations</b>		<b>392.39</b>	<b>315.30</b>	<b>292.79</b>	<b>504.54</b>	<b>635.83</b>	<b>343.88</b>
Profit/ (Loss) from Discontinuing operation		-	-	-	-	-	-
Tax expenses of discontinuing operations		-	-	-	-	-	-
<b>Restated profit for the period</b>		<b>392.39</b>	<b>315.30</b>	<b>292.79</b>	<b>504.54</b>	<b>635.83</b>	<b>343.88</b>

Note: The above statement should be read with the significant accounting policies and notes to restated summary statements of assets and liabilities, and cash flows appearing in Annexure IV, I and III.

**ANNEXURE -III****RESTATED CASH FLOW STATEMENT**

(Amt in Lacs.)

Particulars	For the Period Ended	For the Year ended				
	11/30/2016	3/31/2016	3/31/2015	3/31/2014	3/31/2013	3/31/2012
<b>CASH FLOW FROM OPERATING ACTIVITIES</b>						
Net Profit before tax	583.30	506.19	517.26	755.32	757.18	511.35
Adjustment for :						
Less: Interest on Fixed Deposit	(1.60)	(6.18)	(11.07)	(18.34)	(6.27)	(1.65)
Less: Profit on Sale of Fixed Assets	0.73	0.10	-	2.88	0.01	0.29
Add: Depreciation	239.30	352.40	342.48	352.95	216.27	132.13
Add: Interest on Borrowed Fund & Finance Charges	122.03	472.96	546.94	439.31	194.55	87.51
<b>Operating profit before working capital changes</b>	<b>943.76</b>	<b>1,325.47</b>	<b>1,395.62</b>	<b>1,532.11</b>	<b>1,161.73</b>	<b>729.63</b>
Adjustment for :						
(Increase)/Decrease in Inventories	(693.01)	1,581.33	139.65	(1,397.27)	(1,364.69)	(325.75)
(Increase)/Decrease in Trade Receivables	859.54	(1,018.90)	(284.16)	376.72	223.02	(63.01)
(Increase)/Decrease in Short Term loans and advances	22.11	(155.02)	(255.60)	81.37	(57.38)	(78.62)
(Increase)/Decrease in Other Current Assets	-	-	-	-	-	-
(Increase)/Decrease in Long Term loans and advances	-	-	-	-	-	-
Increase/(Decrease) in trade payables	404.26	(909.34)	185.31	360.98	469.27	151.85
Increase/(Decrease) in Short Term Borrowings	(374.81)	(31.04)	37.81	491.40	997.71	(80.33)
Increase/(Decrease) in Short Term Provisions	(18.42)	7.05	9.79	(2.98)	4.20	0.69
Increase/(Decrease) in other current liabilities	(146.86)	50.83	(116.69)	222.24	18.15	8.83
	<b>52.81</b>	<b>(475.09)</b>	<b>(283.89)</b>	<b>132.45</b>	<b>290.28</b>	<b>(386.34)</b>
<b>Cash generated from / (used in) operations</b>	<b>996.57</b>	<b>850.39</b>	<b>1,111.73</b>	<b>1,664.57</b>	<b>1,452.01</b>	<b>343.28</b>
Income Tax paid/(refund)	77.91	77.51	107.13	131.77	189.60	138.33
<b>Net cash generated from/(used in) operating activities - (A)</b>	<b>918.66</b>	<b>772.88</b>	<b>1,004.60</b>	<b>1,532.79</b>	<b>1,262.41</b>	<b>204.95</b>
<b>CASH FLOW FROM INVESTING ACTIVITIES</b>						
Purchase of tangible fixed assets	(1,282.35)	(402.11)	(276.41)	(587.95)	(1,875.67)	(1,699.17)
(Increase)/Decrease in Capital Work-in-Progress	(677.09)	51.95	(842.87)	-	602.60	-
sale of fixed assets	9.55	7.38	-	1.23	1.22	0.90
(Increase)/Decrease in other Non-Current Assets	(2.39)	42.51	44.66	26.40	(131.52)	(6.34)
Interest Income on Fixed Deposit	1.60	6.18	11.07	18.34	6.27	1.65
Dividend Income	-	-	-	-	-	-
<b>Net cash (used in) Investing Activities - (B)</b>	<b>(1,950.68)</b>	<b>(294.09)</b>	<b>(1,063.54)</b>	<b>(541.98)</b>	<b>(1,397.11)</b>	<b>(1,702.96)</b>
<b>CASH FLOW FROM FINANCING ACTIVITIES</b>						
Proceeds from issue of Share Capital	916.50	-	600.00	-	-	600.00

including share premium						
Proceeds from Loan	247.03	(15.05)	12.45	(548.11)	305.77	1,161.64
Repayment of Long Term borrowings	-	-	-	-	-	-
Interest & Finance Charges	(122.03)	(472.96)	(546.94)	(439.31)	(194.55)	(87.51)
Dividend & DDT	-	-	-	-	-	-
Repayment of Share Application Money	-	-	-	-	-	(151.75)
<b>Net cash(used in) / from financing activities - (C)</b>	<b>1,041.50</b>	<b>(488.01)</b>	<b>65.51</b>	<b>(987.42)</b>	<b>111.22</b>	<b>1,522.38</b>
Net Increase/(decrease) in Cash & Cash Equivalents (A+B+C)	9.48	(9.22)	6.56	3.39	(23.48)	24.38
Cash and cash equivalents at the beginning of the year	6.09	15.31	8.74	5.35	28.83	4.45
Cash and cash equivalents at the end of the year	15.57	6.09	15.31	8.74	5.35	28.83
Cash and cash equivalents at the end of year comprises :						
1. Components of cash and cash equivalents:						
<b>Particulars</b>	<b>9/30/2016</b>	<b>3/31/2016</b>	<b>3/31/2015</b>	<b>3/31/2014</b>	<b>3/31/2013</b>	<b>3/31/2012</b>
Cash on hand	10.97	5.37	5.22	4.64	3.49	0.98
Balances with scheduled banks:						
In current accounts	4.60	0.72	10.09	4.10	1.86	27.85
Total Cash and cash equivalents	15.57	6.09	15.31	8.74	5.35	28.83

**Notes:**

1. The Cash Flow Statement has been prepared under indirect method as set out in Accounting Standard -3 on Cash Flow Statement, specified under the Companies Act, 1956 (which are deemed to be applicable as Section 133 of the Companies Act, 2013 ("the Act") read with Rule 7 of Companies (Accounts) Rules, 2014).

2. Figures in Brackets represents outflow.

3. The above statement should be read with the significant accounting policies and notes to restated summary statements of assets and liabilities, profits and losses as appearing in Annexures IV, I and II.

## THE OFFER

<b>PRESENT OFFER IN TERMS OF THIS PROSPECTUS</b>	
<b>Equity Shares Offered</b>	Public Offering of 65,76,000 Equity Shares of Face Value of ₹ 10/- each for Cash at a Price of ₹ 30.00 Per Equity Share (Including a Share Premium of ₹ 20.00 per Equity Share) aggregating to ₹ 1972.80 lakh <sup>^</sup>
<b>of which</b>	
<b>Reserved for the Market Makers</b>	3,36,000 Equity Shares of ₹ 10/- each fully paid of the Company for cash at a price of ₹ 30.00 per Equity Share aggregating to ₹ 100.80 lakhs
<b>Net Offer to the Public*</b>	62,40,000 Equity Shares of ₹ 10/- each for cash at a price of ₹ 30.00 per Equity Share aggregating to ₹ 1872.00 lakhs
<b>of which</b>	
	31,20,000 Equity Shares of Rs.10/- each at a premium of ₹ 20.00 per Equity Share will be available for allocation for allotment to Retail Individual Investors of up to Rs. 2.00 lakhs
	31,20,000 Equity Shares of Rs.10/- each at a premium of ₹ 20.00 per Equity Share will be available for allocation for allotment to other Investors of above Rs. 2.00 lakhs
<b>Equity Shares outstanding prior to the Offer</b>	2,49,00,000 Equity Shares of face value of Rs.10 each
<b>Equity Shares outstanding after the Offer</b>	2,49,00,000 Equity Shares of face value of Rs.10 each
<b>Use of Offer Proceeds</b>	Our Company will not receive any proceeds from the Offer since the Offer is being made through an offer for sale by the Selling Shareholders.

<sup>^</sup>The Selling Shareholders have authorized their respective participation in the Offer for Sale. For details see “Other Regulatory and Statutory Disclosures” on page 230 of this Prospectus.

1. The Selling Shareholders severally and not jointly, specifically confirm that their portion of the Offered Shares by each of them by way of the Offer, are eligible in accordance with the ICDR Regulations.
2. This Offer is being made in terms of Chapter XB of the SEBI (ICDR) Regulations, 2009, as amended from time to time. For at least 25% of the post-Offer paid-up Equity Share capital of our Company, pursuant to Rule 19(2)(b)(i) of the Securities Contracts (Regulation) Rules, 1957 as amended. For further details please refer to “Offer Structure” on page 250 of this Prospectus.
3. The Board has approved the Offer pursuant to the resolution passed at its meeting held on December 14, 2016 and our Shareholders have approved the Offer pursuant to the resolution passed at their meeting held on December 19, 2016
4. As per Regulation 43(4) of the SEBI (ICDR) Regulations, as amended, since our is a Fixed Price Offer ‘the allocation’ in the net Offer to the public category shall be made as follows:
  - a) Minimum fifty percent to retail individual investors; and
  - b) Remaining to
    - (i) Individual applicants other than retail individual investors; and
    - (ii) Other investors including corporate bodies or institutions, irrespective of the number of specified securities applied for
  - c) The unsubscribed portion in either of the categories specified in (a) or (b) above may be allocated to the applicants in the other category.

*If the retail individual investor category is entitled to more than fifty per cent on proportionate basis, accordingly the retail individual investors shall be allocated that higher percentage.*

For further details, please see “Offer Procedure” on page 252 of this Prospectus.

### GENERAL INFORMATION

Our Company was originally incorporated on May 14, 2004 as “Krishana Phoschem Limited” vide Registration no. 17-019288/2004-2005 (CIN: U24124RJ2004PLC019288) under the provisions of the Companies Act, 1956 with the Registrar of Companies, Rajasthan, Jaipur.

For further details please refer to chapter titled “History and Certain Corporate Matters” beginning on page 122 of this Prospectus.

#### Registered Office of our Company

##### **Krishana Phoschem Limited**

5-O-20 Basement R.C Vyas Colony

Bhilwara, Rajasthan – 311001, India

Tel. No. +91-1482-237104/ 239091/ 230060

Fax No. - +91-1482-239638

E-mail: [secretarial@krishnaphoschem.com](mailto:secretarial@krishnaphoschem.com)

Website: [www.krishnaphoschem.com](http://www.krishnaphoschem.com)

Corporate Identification Number: U24124RJ2004PLC019288

Registration Number: 17-019288/2004-2005

For details relating to changes to the address of our Registered Office, please see “History and Certain Corporate Matters - Changes to the address of the Registered Office of our Company” on page 122 of this Prospectus.

#### Factories Address

##### **Krishana Phoschem Limited**

##### **Unit –I:**

115-120 & 126-133, AKVN Industrial Area,  
Meghnagar, Jhabua, Madhya Pradesh

##### **Unit –II:**

142 & 143, AKVN Industrial Area,  
Meghnagar, Jhabua, Madhya Pradesh

##### **Unit – III:**

126 A & 134, AKVN Industrial Area,  
Meghnagar, Jhabua, Madhya Pradesh

#### Address of Registrar of Companies

##### **Registrar of Companies, Rajasthan, Jaipur**

Corporate Bhawan, G/6-7, Second Floor,

Residency Area, Civil Lines,

Jaipur- 302001, Rajasthan

Phone: 0141-2222465/466;

Fax: 0141-2222464

Email: [roc.jaipur@mca.gov.in](mailto:roc.jaipur@mca.gov.in)

Website: <http://www.mca.gov.in>

#### Board of Directors of our Company

The Board of Directors of our Company consists of:

Name	Designation	Address	DIN
Mr. Praveen Ostwal	Chairman cum Managing Director	5-0-1 R.C. Vyas Colony, Bhilwara – 311001, Rajasthan, India	00412207



Mr. Sunil Kothari	Whole time Director & CFO	30/174 Amlion ki Bari, Bhilwara - 311001, Rajasthan, India	02056569
Mr. Ashish Kothari	Non Executive Independent Director	32, Kashipuri, Bhilwara-311001, Rajasthan, India	06411429
Mr. Pradeep Agarwal	Non Executive Independent Director	45, Azad Nagar , Bhilwara-311001, Rajasthan, India	06458531
Mrs. Priyanka Surana	Non Executive Independent Director	107, Rajendra Marg, Bhilwara- 311001, Rajasthan, India	07679675

For further details of the Directors of our Company, please refer to the chapter titled “Our Management” on page 127 of this Prospectus.

### Company Secretary and Compliance Officer

#### Ms. Priyanka Bansal

Krishana Phoschem Limited  
 5-O-20 Basement R.C Vyas Colony  
 Bhilwara, Rajasthan – 311001, India  
 Tel. No.- +91-1482-237104,  
 Fax No. - +91-1482-239638  
 E-mail: [secretarial@krishnaphoschem.com](mailto:secretarial@krishnaphoschem.com)  
 Website: [www.krishnaphoschem.com](http://www.krishnaphoschem.com)

### Chief Financial Officer

#### Mr. Sunil Kothari

**Krishana Phoschem Limited**  
 5-O-20 Basement R.C. Vyas Colony  
 Bhilwara, Rajasthan – 311001, India  
 Tel. No.- +91-1482-237104,  
 Fax No. - +91-1482-239638  
 E-mail: [secretarial@krishnaphoschem.com](mailto:secretarial@krishnaphoschem.com)  
 Website: [www.krishnaphoschem.com](http://www.krishnaphoschem.com)

Investors may contact our Company Secretary and Compliance Officer and / or the Registrar to the Offer and/ or the Lead Manager, in case of any pre-offer or post-offer related problems such as non-receipt of letters of Allotment, credit of allotted Equity Shares in the respective beneficiary account.

All grievances may be addressed to the Registrar to the Offer with a copy to the relevant Designated Intermediary with whom the ASBA Form was submitted. The applicant should give full details such as name of the sole or first applicant, ASBA Form number, applicant DP ID, Client ID, PAN, date of the ASBA Form, address of the applicant, number of the Equity Shares applied for and the name and address of the Designated Intermediary where the ASBA Form was submitted by the applicant.

Further, the investor shall also enclose the Acknowledgment Slip from the Designated Intermediaries in addition to the documents/ information mentioned hereinabove.

**For all Offer related queries, and for redressal of complaints, applicant may also write to the Lead Manager. All complaints, queries or comments received by Stock Exchange shall be forwarded to the Lead Manager, who shall respond to the same.**

#### Selling Shareholders:-

The details of our Selling Shareholders are set forth below:

Sr. No.	Name of Selling Shareholder	Number of Equity Shares offered for sale
1.	Mahendra Kumar Ostwal	80,000
2.	Pankaj Ostwal HUF	295,000
3.	Praveen Ostwal HUF	295,000

4.	Chunri Prints Pvt. Ltd.	300,000
5.	Paneri Textiles Pvt. Ltd	300,000
6.	Archid Products Pvt. Ltd.	363,750
7.	Mrs. Nitu Ostwal	470,000
8.	Mrs. Ekta Jain	475,000
9.	Mr. Pankaj Ostwal	535,000
10.	Mahendra Kumar Ostwal HUF	550,000
11.	Seasons Agro Chem India Pvt. Limited	11,27,250
12.	Madhya Bharat Agro Products Limited	17,85,000
	<b>Total</b>	<b>65,76,000</b>

**Details of Key Intermediaries pertaining to this Offer and our Company:**
**LEAD MANAGER OF THE OFFER**
**HEM SECURITIES LIMITED**

14/15 Khatau Building, 1st Floor, 40 Bank Street,  
Fort, Mumbai – 400001, Maharashtra, India

**Tel No.:** +91-22-49060000

**Fax No.:** +91-22-22625991

**Email:** [ib@hemsecurities.com](mailto:ib@hemsecurities.com)

**Investor Grievance Email:** [redressal@hemsecurities.com](mailto:redressal@hemsecurities.com)

**Website:** [www.hemsecurities.com](http://www.hemsecurities.com)

**Contact Person:** Mr. Anil Bhargava

**SEBI Regn. No.:** INM000010981

**LEGAL ADVISOR TO THE OFFER**
**VEDANTA LAW CHAMBERS**

Ist Floor, SSK House, B-62, Sahakar Marg, Lal Kothi,  
Jaipur-302015 Rajasthan, India

**Tel:** +91- 141 -2740911, +91- 141 -4014091

**Fax:** +91- 141 -2740911

**Website:** [www.vedantalawchamber.com](http://www.vedantalawchamber.com)

**Email:** [vedantalawchambers@gmail.com](mailto:vedantalawchambers@gmail.com)

**Contact Person:** Advocate Nivedita Ravindra Sarda

**REGISTRAR TO THE OFFER**
**LINK INTIME INDIA PRIVATE LIMITED**

C-13, Pannalal Silk Mills Compound,  
L.B.S. Marg, Bhandup (West), Mumbai-400078,  
Maharashtra-India

**Tel No.:** +91-022-61715400

**Fax No.:** +91-022-25960329

**Email:** [kpl.ipo@linkintime.co.in](mailto:kpl.ipo@linkintime.co.in)

**Investor Grievance Email:** [kpl.ipo@linkintime.co.in](mailto:kpl.ipo@linkintime.co.in)

**Website:** [www.linkintime.co.in](http://www.linkintime.co.in)

**Contact Person:** Ms. Shanti Gopalkrihnan

**SEBI Regn. No.:** INR000004058

**BANKERS TO THE COMPANY**
**HDFC BANK LIMITED**

Shop 2,3,4 SK Plaza, Pur Road,  
Bhilwara – 311001, Rajasthan, India

**Tel No. -** +91-7877775998, +91-7877413232

Email – [vinitjain1@hdfcbank.com](mailto:vinitjain1@hdfcbank.com), [bharti.baharwani@hdfcbank.com](mailto:bharti.baharwani@hdfcbank.com)

Contact Person:- Vinit Jain, Bharti Baharwani

Website: [www.hdfcbank.com](http://www.hdfcbank.com)

#### STATUTORY AUDITORS OF THE COMPANY

**M/S. ASHOK KANTHER & ASSOCIATES.**

**CHARTERED ACCOUNTANTS**

90, Indira Market,

Bhilwara-311001, Rajasthan, India

Tel. No: +91-9414287289

Email: [ashok\\_khanther@yahoo.co.in](mailto:ashok_khanther@yahoo.co.in)

Firm Registration No.: 050014C

Contact Person: CA Ashok Kanther

#### PEER REVIEW AUDITORS

**M/s MANSAKA RAVI & ASSOCIATES**

**CHARTERED ACCOUNTANTS**

34, Fourth Floor, Trinita mall, Swage Farm,

New Sanganer Road, Sodala,

Jaipur-302019, Rajasthan, India

Tel. No.:0141-2297330, +91-9829753254

Email: [caravimansaka@gmail.com](mailto:caravimansaka@gmail.com)

Contact Person: Mr. Ravi Mansaka

#### BANKERS TO THE OFFER

**HDFC BANK LIMITED**

FIG- OPS Department, Lodha I, Think Techno Campus,

Level O-3, Opp. Crompton Greaves,

Next to Kanjurmarg Railway Station,

Kanjurmarg (E), Mumbai - 400042.

Tel No.: +91 – 22 – 3075 2928/27/2914

Fax No.: 022-25799801

Email: [vincent.dsouza@hdfcbank.com](mailto:vincent.dsouza@hdfcbank.com), [siddharth.jadhav@hdfcbank.com](mailto:siddharth.jadhav@hdfcbank.com), [prasanna.uchil@hdfcbank.com](mailto:prasanna.uchil@hdfcbank.com)

Website: [www.hdfcbank.com](http://www.hdfcbank.com)

Contact Person: Vincent Dsouza, Siddhartha Jadhav, Prasanna Uchil

SEBI Registration No. : INB100000063

#### STATEMENT OF INTER SE ALLOCATION OF RESPONSIBILITIES

Since Hem Securities Limited is the sole Lead Manager to this Offer, a statement of inter se allocation of responsibilities among Lead Managers is not required.

#### SELF CERTIFIED SYNDICATE BANKS (“SCSBS”)

The list of Designated Branches that have been notified by SEBI to act as SCSB for the ASBA process is provided on [www.sebi.gov.in/pmd/scsb.pdf](http://www.sebi.gov.in/pmd/scsb.pdf) For more information on the Designated Branches collecting ASBA Forms, see the above mentioned SEBI link.

The list of branches of the SCSBs named by the respective SCSBs to receive deposits of the application forms from the Designated Intermediaries will be available on the website of the SEBI ([www.sebi.gov.in](http://www.sebi.gov.in)) and updated from time to time

#### REGISTERED BROKERS

The list of the Registered Brokers, including details such as postal address, telephone number and e-mail address, is provided on the websites of the NSE at [www.nseindia.com](http://www.nseindia.com), as updated from time to time.

## **REGISTRAR TO THE OFFER AND SHARE TRANSFER AGENTS**

The list of the RTAs eligible to accept application forms at the Designated RTA Locations, including details such as address, telephone number and e-mail address, are provided on the websites of Stock Exchange at [www.nseindia.com](http://www.nseindia.com), as updated from time to time.

## **COLLECTING DEPOSITORY PARTICIPANTS**

The list of the CDPs eligible to accept application forms at the Designated CDP Locations, including details such as name and contact details, are provided on the websites of Stock Exchange at [www.nseindia.com](http://www.nseindia.com), as updated from time to time.

## **BROKERS TO THE OFFER**

All members of the recognized stock exchanges would be eligible to act as Brokers to the Offer.

## **CREDIT RATING**

This being an Offer of Equity Shares, credit rating is not required.

## **IPO GRADING**

Since the Offer is being made in terms of Chapter XB of the SEBI (ICDR) Regulations, there is no requirement of appointing an IPO Grading agency.

## **DEBENTURE TRUSTEES**

As the Offer is of Equity Shares, the appointment of Debenture trustees is not required.

## **TRUSTEES**

As the Offer is of Equity Shares, the appointment of Trustees is not mandatory.

## **MONITORING AGENCY**

The Offer being an offer for sale, our Company will not receive any proceeds from the Offer and is not required to appoint a monitoring agency for the Offer.

## **APPRAISING ENTITY**

No appraising entity has been appointed as our Company will not receive any proceeds from the Offer

## **EXPERTS OPINION**

Except for the reports in the section “Financial Information of the Company” and “Statement of Tax Benefits” on page 157 and page 77 of this Prospectus from the Peer Review Auditors and Statutory Auditor respectively, our Company has not obtained any expert opinions. We have received written consent from the Peer Review Auditors and Statutory Auditor for inclusion of their name. However, the term “expert” shall not be construed to mean an “expert” as defined under the U.S. Securities Act 1933.

## **WITHDRAWAL OF THE OFFER**

Our Company and/or the Selling Shareholders, in consultation with the LM, reserve the right not to proceed with the Offer at any time before the Offer Opening Date without assigning any reason thereof.

If our Company and/or the Selling Shareholders withdraw the Offer anytime after the Offer Opening Date but before the allotment of Equity Shares, a public notice within 2 (two) working days of the Offer Closing Date, providing reasons for not proceeding with the Offer shall be issued by our Company and/or the Selling Shareholders. The notice of withdrawal will be issued in the same newspapers where the pre-offer advertisements have appeared and the Stock Exchange will also be informed promptly. The LM,

through the Registrar to the Offer, will instruct the SCSBs to unblock the ASBA Accounts within 1 (one) working Day from the day of receipt of such instruction.

If our Company and/or the Selling Shareholders withdraw the Offer after the Offer Closing Date and subsequently decides to proceed with an Offer of the Equity Shares, our Company and/or the Selling Shareholders will have to file a fresh Draft Prospectus with the stock exchange where the Equity Shares may be proposed to be listed.

Notwithstanding the foregoing, the Offer is subject to obtaining (i) the final listing and trading approvals of the Stock Exchange with respect to the Equity Shares offered through the Prospectus, which our Company will apply for only after Allotment; and (ii) the final RoC approval of the Prospectus.

## UNDERWRITING

The Company, the selling Shareholders and the Lead Manager to the Offer hereby confirm that the Offer is 100% Underwritten by Hem Securities Limited in the capacity of Underwriter to the Offer.

Pursuant to the terms of the Underwriting Agreement dated January 31, 2017 entered into by Company, the selling shareholders and Underwriter- Hem Securities Limited, the obligations of the Underwriter are subject to certain conditions specified therein. The Details of the Underwriting commitments are as under:

Details of the Underwriter	No. of shares underwritten	Amount Underwritten (₹ in Lakh)	% of Total Offer Size Underwritten
<b>Hem Securities Limited</b> 203, Jaipur Tower, M.I. Road, Jaipur, Rajasthan <b>Tel:</b> 0141- 4051000 <b>Website:</b> <a href="http://www.hemsecurities.com">www.hemsecurities.com</a> <b>Email:</b> <a href="mailto:underwriter@hemsecurities.com">underwriter@hemsecurities.com</a> <b>Contact Person:</b> Mr. Anil Bhargava <b>SEBI Regn. No.</b> INM000010981	65,76,000* Equity Shares of ₹ 10/- being offered at ₹ 30/- each	<b>1972.80</b>	100%

\*Includes 3,36,000 Equity Shares of the Market Maker Reservation Portion which are to be subscribed by the Market Maker Hem Finlease Private Limited in its OWN account in order to claim compliance with the requirements of Regulation 106 V (4) of the SEBI (ICDR) Regulations, 2009, as amended.

As per Regulation 106P (2) of SEBI (ICDR) Regulations, the Lead Manager has agreed to underwrite to a minimum extent of 15 % of the Offer out of its own account.

In the opinion of the Board of Directors of our Company, the resources of the above mentioned Underwriter are sufficient to enable them to discharge their respective obligations in full.

## DETAILS OF THE MARKET MAKING ARRANGEMENT FOR THIS OFFER

Our Company and the Lead Manager has entered into Market Making Agreement dated January 31, 2017 with the following Market Maker, to fulfill the obligations of Market Making for this Offer:

<b>Name</b>	Hem Finlease Private Limited
<b>Correspondence Address:</b>	203, Jaipur Tower, M.I. Road, Jaipur – 302 001, Rajasthan, India
<b>Tel No.:</b>	+ 91 - 141 – 4051000, 5108133
<b>E-mail:</b>	<a href="mailto:hem@hemsecurities.com">hem@hemsecurities.com</a>
<b>Website:</b>	<a href="http://www.hemsecurities.com">www.hemsecurities.com</a>
<b>Contact Person:</b>	Mr. Anil Bhargava
<b>SEBI Registration No.:</b>	INB231110033
<b>Market Maker Registration No.</b>	11100

The Market Maker shall fulfill the applicable obligations and conditions as specified in the SEBI (ICDR) Regulations, and its amendments from time to time and the circulars issued by the NSE and SEBI regarding this matter from time to time. Following is a summary of the key details pertaining to the Market Making arrangement:

- 1) The Market Maker(s) (individually or jointly) shall be required to provide a 2-way quote for 75% of the time in a day. The same shall be monitored by the stock exchange. Further, the Market Maker(s) shall inform the exchange in advance for each and every black out period when the quotes are not being offered by the Market Maker(s).
- 2) The prices quoted by Market Maker shall be in compliance with the Market Maker Spread Requirements and other particulars as specified or as per the requirements of SME Platform of NSE and SEBI from time to time.
- 3) The minimum depth of the quote shall be ₹ 1,00,000/-. However, the investors with holdings of value less than ₹ 1,00,000/- shall be allowed to offer their holding to the Market Maker(s) (individually or jointly) in that script provided that he sells his entire holding in that script in one lot along with a declaration to the effect to the selling broker.
- 4) The Market Maker shall not sell in lots less than the minimum contract size allowed for trading on the SME Platform (in this case currently the minimum trading lot size is 4000 equity shares; however the same may be changed by the SME Platform of NSE from time to time).
- 5) After a period of three (3) months from the market making period, the Market Maker would be exempted to provide quote if the Shares of Market Maker in our company reaches to 25% of Offer Size. Any Equity Shares allotted to Market Maker under this Offer over and above 25% of Offer Size would not be taken in to consideration of computing the threshold of 25% of Offer Size. As soon as the Shares of Market Maker in our Company reduces to 24% of Offer Size, the Market Maker will resume providing 2 way quotes.
- 6) There shall be no exemption/threshold on downside. However, in the event the Market Maker exhausts his inventory through market making process, NSE may intimate the same to SEBI after due verification.
- 7) Execution of the order at the quoted price and quantity must be guaranteed by the Market Maker(s), for the quotes given by him.
- 8) There would not be more than five Market Makers for a script at any point of time and the Market Makers may compete with other Market Makers for better quotes to the investors.
- 9) On the first day of the listing, there will be pre-opening session (call auction) and there after the trading will happen as per the equity market hours. The circuits will apply from the first day of the listing on the discovered price during the pre-open call auction.
- 10) The Marker maker may also be present in the opening call auction, but there is no obligation on him to do so.
- 11) There will be special circumstances under which the Market Maker may be allowed to withdraw temporarily/fully from the market – for instance due to system problems, any other problems. All controllable reasons require prior approval from the Exchange, while *force-majeure* will be applicable for non controllable reasons. The decision of the Exchange for deciding controllable and non-controllable reasons would be final
- 12) The Market Maker(s) shall have the right to terminate said arrangement by giving a six months notice or on mutually acceptable terms to the Merchant Banker, who shall then be responsible to appoint a replacement Market Maker(s) and execute a fresh arrangement.

In case of termination of the above mentioned Market Making agreement prior to the completion of the compulsory Market Making period, it shall be the responsibility of the Lead Manager to arrange for another Market Maker in replacement during the term of the notice period being served by the Market Maker but prior to the date of releasing the existing Market Maker from its duties in order to ensure compliance with the requirements of regulation 106 V of the SEBI (ICDR) Regulations, 2009, as amended. Further our Company and the Lead Manager reserve the right to appoint other Market Makers either as a replacement of the current Market Maker or as an additional Market Maker subject to the total number of Designated Market Makers does not exceed five or as specified by the relevant laws and regulations applicable at that particulars point of time. The Market Making Agreement is available for inspection at our office from 11.00 a.m. to 5.00 p.m. on working days.

- 13) **Risk containment measures and monitoring for Market Makers:** NSE SME Exchange will have all margins, which are applicable on the NSE main board viz., Mark-to-Market, Value-At-Risk (VAR) Margin, Extreme Loss Margin, Special Margins and Base Minimum Capital etc. NSE can impose any other margins as deemed necessary from time-to-time.

- 14) **Punitive Action in case of default by Market Makers:** NSE SME Exchange will monitor the obligations on a real time basis and punitive action will be initiated for any exceptions and/or non-compliances. Penalties / fines may be imposed by the Exchange on the Market Maker, in case he is not able to provide the desired liquidity in a particular security as per the specified guidelines. These penalties / fines will be set by the Exchange from time to time. The Exchange will impose a penalty on the Market Maker in case he is not present in the market (offering two way quotes) for at least 75% of the time. The nature of the penalty will be monetary as well as suspension in market making activities / trading membership.

The Department of Surveillance and Supervision of the Exchange would decide and publish the penalties / fines / suspension for any type of misconduct/ manipulation/ other irregularities by the Market Maker from time to time.

- 15) **Price Band and Spreads:** The price band shall be 20% and the market maker spread (difference between the sell and the buy quote) shall be within 10% or as intimated by Exchange from time to time
- 16) Pursuant to SEBI Circular number CIR/MRD/DSA/31/2012 dated November 27, 2012, limits on the upper side for market makers during market making process has been made applicable, based on the Offer size and as follows:

Offer Size	Buy quote exemption threshold (including mandatory initial inventory of 5% of the Offer Size)	Re-Entry threshold for buy quote (including mandatory initial inventory of 5% of the Offer Size)
Up to ₹ 20 Crore	25%	24%
₹ 20 to ₹ 50 Crore	20%	19%
₹ 50 to ₹ 80 Crore	15%	14%
Above ₹ 80 Crore	12%	11%

- 17) All the above mentioned conditions and systems regarding the Market Making Arrangement are subject to change based on changes or additional regulations and guidelines from SEBI and Stock Exchange from time to time.

### CAPITAL STRUCTURE

The Equity Share capital of our Company, as on the date of the Prospectus and after giving effect to this Offer, is set forth below:

		Amount (Rs. in Lacs, except share data)	
Sr. No.	Particulars	Aggregate nominal Value	Aggregate Value at Offer Price
A	<b>Authorized Share Capital</b> 2,50,00,000 Equity Shares having Face Value of Rs 10/- each	2,500.00	-
B	<b>Issued, Subscribed &amp; Paid-up Share Capital prior to the Offer</b> 2,49,00,000 Equity Shares having Face Value of Rs.10/- each fully paid up before the Offer.	2490.00	-
C	<b>Present Offer in terms of the Prospectus</b> Offer for Sale of 65,76,000 Equity Shares having Face Value of Rs.10/- each with a premium of ₹ 20.00 per Equity Share.	657.60	1972.80
	<b>Which Comprises</b>		
I.	<b>Reservation for Market Maker portion</b> 3,36,000 Equity Shares of Rs. 10/- each at a premium of ₹ 20.00 per Equity Share	33.60	100.80
II.	<b>Net Offer to the Public</b> 62,40,000 Equity Shares of Rs.10/- each at a premium of ₹ 20.00 per Equity Share	624.00	1872.00
	<b>of which</b>		
	31,20,000 Equity Shares of Rs.10/- each at a premium of ₹ 20.00 per Equity Share will be available for allocation for allotment to Retail Individual Investors applying for a value of up to Rs. 2.00 Lacs	312.00	936.00
	31,20,000 Equity Shares of Rs.10/- each at a premium of ₹ 20.00 per Equity Share will be available for allocation for allotment to Other Investors applying for a value of above Rs. 2.00 Lacs	312.00	936.00
D	<b>Issued, Subscribed and Paid up Equity Share capital after the Offer</b> 2,49,00,000 Equity Shares having Face Value of ₹ 10/- each	2490.00	
E	<b>Securities Premium Account</b>		
	Before the Offer		826.50
	After the Offer		826.50

*\*The offer of 65,76,000 Equity Shares in terms of Prospectus has been authorized pursuant to a resolution of our Board of Directors dated December 14, 2016 and by special resolution passed under section 28 of the Companies Act, 2013 at the Extra Ordinary General meeting of the members held on December 19, 2016*

*\*The Offer for sale by Mahendra Kumar Ostwal, Pankaj Ostwal HUF, Praveen Ostwal HUF, Chunri Prints Pvt. Ltd, Paneri Textiles Pvt. Ltd, Archid Products Pvt. Ltd, Mrs. Nitu Ostwal, Mrs. Ekta Jain, Mr. Pankaj Ostwal, Mahendra Kumar Ostwal HUF, Seasons Agro Chem India Pvt. Ltd, Madhya Bharat Agro Products Limited, ("Promoter & Promoter Group Selling Shareholders") for 65,76,000 Equity Shares has been authorized by their respective undertakings/Board resolution dated December 12, 2016.*

#### **Class of Shares**

Our Company has only one class of share capital i.e. Equity Shares of Rs.10/- each only. All Equity Shares issued are fully paid up. Our Company does not have any outstanding convertible instruments as on the date of the Prospectus.

#### **Details of changes in Authorized Share Capital of our Company:**

Since the incorporation of our Company, the authorized share capital of our Company has been altered in the manner set forth below:



- a) The initial authorised share capital of our Company was ₹ 5.00 Lakh divided into 50,000 Equity Shares of ₹10/- each. This authorised capital was increased to ₹ 200.00 Lakh divided into 20,00,000 Equity Shares of ₹ 10/- each pursuant to a resolution passed by our Shareholders in their extra-ordinary general meeting held on September 06, 2004.
- b) The authorised capital of our Company of ₹ 200.00 Lakh divided into 20,00,000 Equity Shares of ₹10/- each was increased to ₹ 260.00 Lakh divided into 26,00,000 Equity Shares of ₹ 10/- each pursuant to a resolution passed by our Shareholders in their extra-ordinary general meeting held on June 16, 2005.
- c) The authorised capital of our Company of ₹ 260.00 Lakh divided into 26,00,000 Equity Shares of ₹10/- each was increased to ₹ 600.00 Lakh divided into 60,00,000 Equity Shares of ₹ 10/- each pursuant to a resolution passed by our Shareholders in their extra-ordinary general meeting held on February 14, 2008.
- d) The authorised capital of our Company of ₹ 600.00 Lakh divided into 60,00,000 Equity Shares of ₹10/- each was increased to ₹ 1200.00 Lakh divided into 1,20,00,000 Equity Shares of ₹ 10/- each pursuant to a resolution passed by our Shareholders in their extra-ordinary general meeting held on March 21, 2011.
- e) The authorised capital of our Company of ₹ 1200.00 Lakh divided into 1,20,00,000 Equity Shares of ₹10/- each was increased to ₹ 2000.00 Lakh divided into 2,00,00,000 Equity Shares of ₹ 10/- each pursuant to a resolution passed by our Shareholders in their extra-ordinary general meeting held on December 26, 2011.
- f) The authorised capital of our Company of ₹ 2000.00 Lakh divided into 2,00,00,000 Equity Shares of ₹10/- each was increased to ₹ 2500.00 Lakh divided into 2,50,00,000 Equity Shares of ₹ 10/- each pursuant to a resolution passed by our Shareholders in their extra-ordinary general meeting held on August 04, 2014.

## Notes to Capital Structure

### 1. Equity Share Capital History of our Company:

- (a) The history of the equity share capital and the securities premium account of our company are set out in the following table:-

Date of Allotment / Date of Fully Paid Up	No. of Equity Shares allotted	Face Value (Rs.)	Issue Price (Rs.)	Nature of Consideration	Nature of Allotment	Cumulative No. of Equity Shares	Cumulative Paid Up Share Capital (Rs.)	Cumulative Securities Premium (Rs.)
On Incorporation*	50,000	10	10	Cash	Subscription to MOA <sup>(i)</sup>	50,000	5,00,000	Nil
September 11, 2004	19,40,000	10	10	Cash	Further Allotment <sup>(ii)</sup>	19,90,000	1,99,00,000	Nil
September 26, 2006	6,10,000	10	10	Cash	Preferential Allotment <sup>(iii)</sup>	26,00,000	2,60,00,000	Nil
March 31, 2008	11,00,000	10	10	Cash	Preferential Allotment <sup>(iv)</sup>	37,00,000	3,70,00,000	Nil
October 31, 2008	12,00,000	10	10	Cash	Preferential Allotment <sup>(v)</sup>	49,00,000	4,90,00,000	Nil
March 28, 2009	8,50,000	10	10	Cash	Preferential Allotment <sup>(vi)</sup>	57,50,000	5,75,00,000	Nil
October 10, 2009	2,50,000	10	10	Cash	Preferential Allotment <sup>(vii)</sup>	60,00,000	6,00,00,000	Nil
September 30, 2011	60,00,000	10	10	Cash	Preferential Allotment <sup>(viii)</sup>	1,20,00,000	12,00,00,000	Nil
December 27, 2011 <sup>^</sup>	60,00,000	10	--	--	Bonus issue in the ratio of 1:2 <sup>(ix)</sup>	1,80,00,000	18,00,00,000	Nil
November 17, 2014	30,00,000	10	20	Cash	Preferential	2,10,00,000	21,00,00,000	3,00,00,000

					Allotment <sup>(x)</sup>			
October 05, 2016	39,00,000	10	23.50	Cash	Preferential Allotment <sup>(xi)</sup>	2,49,00,000	24,90,00,000	8,26,50,000

\* The Shares was allotted to Initial Subscriber to Memorandum of Association on July 21, 2004.

^ Bonus issue of 60,00,000 equity shares in the ratio of 1:2 dated December 27, 2011 has been issued by Capitalization of Reserve & Surplus of the Company.

All the above mentioned shares are fully paid up since the date of allotment.

**Notes:**

1. **Initial Subscribers to the Memorandum of Association subscribed 50,000 Equity Shares of Face Value of Rs. 10/- each, details of which are given below:**

S. No.	Names of Person	Number of Shares Allotted
1.	Mr. Roop Lal Patel	20,000
2.	Mrs. Leela Patel	2,500
3.	Mr. Jitendra Patel	2,000
4.	Mr. Vinod Paliwal	2,500
5.	Mrs. Geeta Paliwal	20,000
6.	Mr. Narendra Paliwal	2,000
7.	Mr. Dilip Kumar Gadia	1,000
<b>Total</b>		<b>50,000</b>

- (ii) **Further allotment of 19,40,000 Equity Shares of Face Value of Rs. 10/- each fully paid:**

S. No.	Names of Person	Number of Shares Allotted
1.	Mr. Roop Lal Patel	7,71,500
2.	Mrs. Leela Patel	2,25,000
3.	Mr. Jitendra Patel	67,500
4.	Mr. Roshan Patel	80,000
5.	Mrs. Geeta Paliwal	2,76,000
6.	Mr. Pushkar Patel	40,000
7.	Mr. Madhav Lal Suthar	2,12,500
8.	Mrs. Shilpi Chauhan	1,47,500
9.	Mr. Doulat Ram Patel	80,000
10.	Mr. Vardhi Chand	40,000
<b>Total</b>		<b>19,40,000</b>

- (iii) **Preferential allotment of 6,10,000 Equity Shares of Face Value of Rs. 10/- each fully paid:**

S. No.	Names of Person	Number of Shares Allotted
1.	Mrs. Geeta Paliwal	2,45,000
2.	Mr. Shailendra Garg	1,15,000
3.	Mrs. Deepa Paliwal	60,000
4.	Mr. Kamlesh Goyal	40,000
5.	Mr. Anil Garg	50,000
6.	Mrs. Pooja Goyal	25,000
7.	Mrs. Chanda Goyal	35,000
8.	Mr. Manoj Garg	20,000
9.	Mr. Praveen Garg	20,000
<b>Total</b>		<b>6,10,000</b>

(iv) Preferential allotment of 11,00,000 Equity Shares of Face Value of Rs. 10/- each fully paid

S. No.	Names of Person	Number of Shares Allotted
1.	Chunri Prints Private Limited	5,30,000
2.	Paneri Textiles Pvt. Ltd.	4,00,000
3.	Seasons Agro Chem India Pvt. Ltd.	1,70,000
	<b>Total</b>	<b>11,00,000</b>

(v) Preferential allotment of 12,00,000 Equity Shares of Face Value of Rs. 10/- each fully paid

S. No.	Names of Person	Number of Shares Allotted
1.	Mr. Shailendra Garg	3,00,000
2.	Mrs. Sonali Garg	1,50,000
3.	Mr. Mahendra Garg	1,50,000
4.	Madhya Bharat Agro Products Ltd.	6,00,000
	<b>Total</b>	<b>12,00,000</b>

(vi) Preferential allotment of 8,50,000 Equity Shares of Face Value of Rs. 10/- each fully paid at Issue Price of Rs. 10

S. No.	Names of Person	Number of Shares Allotted
1.	M/s Gauri Silk Mills (Prop. Navratan Jain)	35,000
2.	Mr. Kamlesh Jain	16,000
3.	Mr. Kanti Sumra	15,000
4.	Mr. Mukesh Bafna	15,000
5.	M/s Nirmal D Shah (HUF)	14,000
6.	M/s Renuka Textiles (Prop. Akilesh Jain)	1,25,000
7.	M/s Saroj Saree (Prop. Kusum R Jain)	1,50,000
8.	M/s Shri Ram Traders (Prop. M/s Suresh Jain HUF)	75,000
9.	Chunri Prints Pvt. Ltd.	1,05,000
10.	Paneri Textiles Pvt. Ltd.	55,000
11.	M/s Ronak Silk Mills (Prop. Lokesh Mathur)	1,00,000
12.	M/s Shailesh Fabrics (Prop. M/s Raj Kumar Mathur HUF)	50,000
13.	Mr. Surendra Kumar Maro	10,000
14.	Mr. Sunder Lal Gokharu	20,000
15.	M/s Sunder Lal Gokharu HUF	20,000
16.	Mr. Balchand Shah	20,000
17.	Mr. Bhanwar Lal Sipani	25,000
	<b>Total</b>	<b>8,50,000</b>

(vii) Preferential allotment of 2,50,000 Equity Shares of Face Value of Rs. 10/- each fully paid at Issue Price of Rs. 10

S. No.	Names of Person	Number of Shares Allotted
1.	Mr. Basant Patwa	250,000
	<b>Total</b>	<b>2,50,000</b>

(viii) Preferential allotment of 60,00,000 Equity Shares of Face Value of Rs. 10/- each fully paid at Issue Price of Rs. 10

S. No.	Names of Person	Number of Shares Allotted
1.	Archid Products Pvt. Ltd.	11,81,000
2.	Chunri Prints Pvt. Ltd.	6,13,000
3.	Paneri Textiles Pvt. Ltd.	5,49,500
4.	Seasons Agro Chem India Pvt. Ltd.	9,44,000
5.	Shubhlaxmi Texfeb Pvt. Ltd.	5,10,000
6.	Suswani Textiles Pvt. Ltd.	3,38,000
7.	Swastik Clothtex Pvt. Ltd.	9,60,000

**Krishana Phoschem Limited**

8.	Vesta Tex Pvt. Ltd.	6,42,500
9.	Visualize Tradecom Pvt. Ltd.	2,62,000
	<b>Total</b>	<b>60,00,000</b>

- (ix) **Bonus allotment of 60,00,000 Equity Shares of Face Value of Rs. 10/- each fully paid in the ration 1:2 i.e.1 Bonus Equity Shares for every 2 Equity Shares held**

S. No.	Names of Person	Number of Shares Allotted
1.	Mr. Pankaj Ostwal	1,60,000
2.	Mrs. Ekta Jain	1,60,000
3.	Mr. Praveen Ostwal	1,60,000
4.	Mrs. Nitu Ostwal	1,57,500
5.	M/s Pankaj Ostwal HUF	1,00,000
6.	M/s Praveen Ostwal HUF	1,00,000
7.	M/s M.K. Ostwal HUF	1,27,500
8.	Seasons Agro Chem India Pvt. Ltd.	13,37,000
9.	Madhya Bharat Agro Products Ltd.	6,15,000
10.	Vesta Tex Pvt. Ltd	3,21,250
11.	Archid Products Pvt. Ltd.	5,90,500
12.	Chunri Prints Pvt. Ltd.	3,06,500
13.	Paneri Textile Pvt. Ltd.	2,74,750
14.	Swastik Cohtex Pvt. Ltd.	4,80,000
15.	Mr. Basant Patwa	1,90,000
16.	Mrs. Sudha Patwa	65,000
17.	Shublaxmi Texfeb Pvt. Ltd.	2,55,000
18.	Mr. Shailendra Garg	1,50,000
19.	Mrs. Sonali Garg	75,000
20.	Mr. Mahendra Garg	75,000
21.	Suswani Textile Pvt. Ltd.	1,69,000
22.	Visualize Tradecom Pvt. Ltd.	1,31,000
	<b>Total</b>	<b>60,00,000</b>

- (x) **Preferential allotment of 30,00,000 Equity Shares of Face Value of Rs. 10/- each fully paid at Issue Price of Rs. 20 (including Securities premium of Rs. 10/- each)**

S. No.	Names of Person	Number of Shares Allotted
1.	Ostwal Phoschem (India) Ltd. (Formerly Known as Tedco Granite Limited)	30,00,000
	<b>Total</b>	<b>30,00,000</b>

- (xi) **Preferential allotment of 39,00,000 Equity Shares of Face Value of Rs. 10/- each fully paid at Issue Price of Rs. 23.50 (including Securities premium of Rs. 13.50/- each)**

S. No.	Names of Person	Number of Shares Allotted
1.	Ostwal Phoschem (India) Ltd. (Formerly Known as Tedco Granite Limited)	39,00,000
	<b>Total</b>	<b>39,00,000</b>

b) As on the date of the Prospectus, our Company does not have any preference share capital.

## 2. Issue of Equity Shares for consideration other than cash

Save and Except as set out below we have not issued any Equity Shares for consideration other than cash:

Date of the allotment	No. of Equity shares allotted	Face Value (₹)	Issue Price (₹)	Reasons for allotment	Benefit Accrued to our Company	Allottees	No. of Shares allotted
December 27, 2011	60,00,000	10	NIL	Bonus Issue of equity shares in the ratio of 1:2 by way of capitalization of Reserves & Surplus of ₹ 600 Lakh*	Expansion of Capital	Mr. Pankaj Ostwal	160000
						Mrs. Ekta Jain	160000
						Mr. Praveen Ostwal	160000
						Mrs. Nitu Ostwal	157500
						M/s Pankaj Ostwal HUF	100000
						M/s Praveen Ostwal HUF	100000
						M/s M.K. Ostwal HUF	127500
						Seasons Agro Chem India Pvt. Ltd.	1337000
						Madhya Bharat Agro Products Ltd.	615000
						Vesta Tex Pvt. Ltd	321250
						Archid Products Pvt. Ltd.	590500
						Chunri Prints Pvt. Ltd.	306500
						Paneri Textile Pvt. Ltd.	274750
						Swastik Cohtex Pvt. Ltd.	480000
						Mr. Basant Patwa	190000
						Mrs. Sudha Patwa	65000
						Shublaxmi Texfeb Pvt. Ltd.	255000
Mr. Shailendra Garg	150000						
Mrs. Sonali Garg	75000						
Mr. Mahendra Garg	75000						
Suswani Textile Pvt. Ltd.	169000						
Visualize Tradecom Pvt. Ltd.	131000						

\*Above allotment of shares have been made out of Reserves & Surplus available for distribution to shareholders and no part of revaluation reserve has been utilized for the purpose.

### 3. Details of Allotment made in the last two years preceding the date of the Prospectus:

Except as mentioned in point 1 (a) (xi) above, we have not issued any Equity Shares in the last two years preceding the date of the Prospectus

- No Equity Shares have been allotted pursuant to any scheme approved under Section 391-394 of the Companies Act, 1956.
- We have revalued our assets since inception for details of the revaluation of assets refer chapter titled "History and certain Corporate Matters" beginning on page 122 of the Prospectus. However, we have not issued any Equity Shares (including bonus shares) by capitalizing any revaluation reserves.
- Except as mentioned below, no Equity Shares have been issued which may at price below the Offer Price within last one year from the date of the Prospectus.

Date of Allotment	Allottees	No. of Equity Shares Allotted	Face Value (in ₹)	Issue Price (in ₹)	Reason for Allotment	Category of Allottees
October 05, 2016	Ostwal Phoschem (India) Ltd. (Formerly Known as Tedco Granite Limited)	39,00,000	10	23.5	Preferential Allotment	Promoter

**7. Capital Build up in respect of shareholding of our Promoters:**

As on date of the Prospectus, our promoters Mr. Praveen Ostwal, Seasons Agro Chem India Pvt. Ltd., Ostwal Phoschem (India) Ltd (formerly Known as Tedco Granite limited) hold 6,78,500, 23,87,500 & 97,66,500 Equity Shares respectively of our Company. None of the Equity Shares held by our Promoters are subject to any pledge.

Date of Allotment and made fully paid up /transfer	Nature of Issue	No. of Equity Shares	Face Value Per Share (₹)	Issue /Acquisition/ Transfer Price per Equity Share (₹)*	Pre-Offer Shareholding %	Post-Offer Shareholding %	Lock in Period	Source of Funds
<b>Mr. Praveen Ostwal</b>								
June 06, 2007	Acquisition of Shares by way of Transfer <sup>(i)</sup>	75,000	10	10	0.30	0.30	3 Years	Own fund
December 02, 2011	Acquisition of Shares by way of Transfer <sup>(ii)</sup>	2,45,000	10	10	0.98	0.98	3 Years	Own fund
December 27, 2011	Bonus Issue	1,60,000	10	--	0.64	0.64	3 Years	--
October 15, 2013	Acquisition of Shares by way of Transfer <sup>(iii)</sup>	1,98,500	10	17	0.80	0.80	3 Years	Own fund
<b>Total (A)</b>		<b>6,78,500</b>						
<b>Seasons Agro Chem India Private Limited</b>								
June 06, 2007	Acquisition of Shares by way of Transfer <sup>(iv)</sup>	<u>1,06,500</u> 14,53,500	10	10	<u>0.43</u> 5.84	<u>0.43</u> 5.84	<u>3 Years</u> --	Own fund
March 31, 2008	Allotment	1,70,000	10	10	0.68	0.68	--	Own fund
September 30, 2011	Allotment	<u>1,13,500</u> 8,30,500	10	10	<u>0.46</u> 3.34	<u>0.46</u> 3.34	<u>3 Years</u> 1 Years	Own fund
December 27, 2011	Bonus	<u>11,27,250</u> 2,09,750	10	---	<u>4.53</u> 0.84	<u>4.53</u> 0.84	<u>OFS*</u> 1 Years	--
October 15, 2013	Transfer <sup>(v)</sup>	(4,53,500)	10	17	-1.82	-1.82	1 Years	--
March 24, 2015	Transfer <sup>(vi)</sup>	(11,70,000)	10	20	-4.70	-4.70	1 Years	--
<b>Total (B)</b>		<b>23,87,500</b>						
<b>Ostwal Phoschem India Limited (Formerly Known as Tedco Granite Limited)</b>								
November 17, 2014	Allotment	30,00,000	10	20	12.05	12.05	3 Years	Own fund
March 24, 2015	Acquisition of Shares by way of Transfer <sup>(vii)</sup>	12,01,500	10	20	4.83	4.83	3 Years	Own fund
March 30, 2016	Acquisition of Shares by way of Transfer <sup>(viii)</sup>	7,65,000	10	22	3.07	3.07	1 Years	Own fund
August 12, 2016	Acquisition of shares by way of Transfer <sup>(ix)</sup>	9,00,000	10	23	3.61	3.61	1 Years	Own fund
October 05, 2016	Allotment	39,00,000	10	23.5	15.66	15.66	1 Years	Own fund
<b>Total (C)</b>		<b>97,66,500</b>						
<b>Grand Total (A+B+C)</b>		<b>1,28,32,500</b>						

\*11,27,250 Shares of Seasons Agro Chem India Pvt. Ltd are offered in this Public Offer vide authorization letter/Board Resolution dated December 12, 2016.

## (i) Details of Acquisition of Share by Mr. Praveen Ostwal dated October 06, 2007

S. No.	Date of Transfer	Name of Transferor	No. of Share Transfer	Name of Transferee
1	06.06.2007	Kamlesh Goyal	20000	Praveen Ostwal
2	06.06.2007	Manoj Kumar Garg	20000	Praveen Ostwal
3	06.06.2007	Chanda Goyal	35000	Praveen Ostwal
<b>Total</b>			<b>75000</b>	

## (ii) Details of Acquisition of Share by Mr. Praveen Ostwal dated December 02, 2011

S. No.	Date of Transfer	Name of Transferor	No. of Share Transfer	Name of Transferee
1	02.12.2011	M/s B.G. Creation (Prop. Ranjan Giri)	37500	Praveen Ostwal
2.	02.12.2011	M/s Akilesh Textile (Prop. Akilesh Jain)	45000	Praveen Ostwal
3.	02.12.2011	M/s Pushpa Fabrics (Prop. Santosh Suresh Jain)	37500	Praveen Ostwal
4.	02.12.2011	M/s Shriram Traders (Prop. M/s Suresh Jain HUF)	50000	Praveen Ostwal
5.	02.12.2011	M/s Saroj Saree (Prop. Kusum R Jain)	50000	Praveen Ostwal
6.	02.12.2011	M/s Renuka Textile (Prop. Akliesh Jain)	25000	Praveen Ostwal
<b>Total</b>			<b>245000</b>	

## (iii) Details of Acquisition of Share by Mr. Praveen Ostwal dated October 15, 2013

S. No.	Date of Transfer	Name of Transferor	No. of Share Transfer	Name of Transferee
1	15.10.2013	Seasons Agro Chem India Pvt. Ltd.	198500	Praveen Ostwal
<b>Total</b>			<b>198500</b>	

## (iv) Details of Acquisition of Share by Seasons Agro Chem India Pvt. Ltd. dated June 06, 2007

S. No.	Date of Transfer	Name of Transferor	No. of Share Transfer	Name of Transferee
1	06.06.2007	Naresh chand Garg	2,60,000	Seasons Agro Chem India Pvt. Ltd.
2.	06.06.2007	Sonali Garg	2,63,000	Seasons Agro Chem India Pvt. Ltd
3.	06.06.2007	Mahendra Kumar Garg	2,50,000	Seasons Agro Chem India Pvt. Ltd
4.	06.06.2007	Anil Kumar Garg	40,000	Seasons Agro Chem India Pvt. Ltd
5.	06.06.2007	Shailendra Garg	3,37,000	Seasons Agro Chem India Pvt. Ltd
6.	06.06.2007	Geeta Paliwal	4,10,000	Seasons Agro Chem India Pvt. Ltd
<b>Total</b>			<b>15,60,000</b>	

## (v) Details of Transfer of Seasons Agro Chem India Pvt. Ltd dated October 15, 2013

S. No.	Date of Transfer	Name of Transferor	No. of Share Transfer	Name of Transferee
1	15.10.2013	Seasons Agro Chem India Pvt. Ltd.	198500	Praveen Ostwal
2.	15.10.2013	Seasons Agro Chem India Pvt. Ltd.	170000	M/s M.K. Ostwal HUF
3.	15.10.2013	Seasons Agro Chem India Pvt. Ltd.	85000	Mahendra Kumar Ostwal

<b>Total</b>	<b>453500</b>
--------------	---------------

**(vi) Details of Transfer of Seasons Agro Chem India Pvt. Ltd dated March 24, 2015**

S. No.	Date of Transfer	Name of Transferor	No. of Share Transfer	Name of Transferee
1	24.03.2015	Seasons Agro Chem India Private Limited	11,70,000	Ostwal Phoschem India Ltd.
<b>Total</b>			<b>11,70,000</b>	

**(vii) Details of Acquisition of Share by Ostwal Phoschem India Ltd. dated March 24, 2015**

S. No.	Date of Transfer	Name of Transferor	No. of Share Transfer	Name of Transferee
1	24.03.2015	Seasons Agro Chem India Private Limited	11,70,000	Ostwal Phoschem India Ltd.
2	24.03.2015	Chunri Prints Private Limited	31,500	Ostwal Phoschem India Ltd.
<b>Total</b>			<b>12,01,500</b>	

**(viii) Details of Acquisition of Share by Ostwal Phoschem India Ltd. dated March 30, 2016**

S. No.	Date of Transfer	Name of Transferor	No. of Share Transfer	Name of Transferee
1	30.03.2016	Basant Patwa	5,70,000	Ostwal Phoschem India Ltd.
2.	30.03.2016	Sudha Patwa	1,95,000	Ostwal Phoschem India Ltd.
<b>Total</b>			<b>7,65,000</b>	

**(ix) Details of Acquisition of Share by Ostwal Phoschem India Ltd. dated August 12, 2016**

S. No.	Date of Transfer	Name of Transferor	No. of Share Transfer	Name of Transferee
1	12.08.2016	Sonali Garg	2,25,000	Ostwal Phoschem India Ltd.
2.	12.08.2016	Shailendra Garg	4,50,000	Ostwal Phoschem India Ltd.
3.	12.08.2016	Mahendra Garg	2,25,000	Ostwal Phoschem India Ltd.
<b>Total</b>			<b>9,00,000</b>	

**7. The average cost of acquisition of or subscription to Equity Shares by our Promoter is set forth in the table below:**

Name of the Promoter	No. of Shares held	Average Cost of Acquisition per Share (In Rs.)*
Mr. Praveen Ostwal	6,78,500	9.69
Seasons Agro Chem India Private Limited	23,87,500	4.40
Ostwal Phoschem (India) Ltd.	97,66,500	21.83

\*Average cost of acquisition is calculated on the basis of face value of equity shares of Rs. 10/- each.

8. Except as provided below there are no Equity Shares purchased/acquired or sold by our Promoters, Promoter Group and/or by our Directors and their immediate relatives within six months immediately preceding the date of filing of the Prospectus.

Date of Transaction	Number of Equity Shares Allotted/ Acquired	Face Value (Rs. )	Issue Price/ Acquired Price (Rs.)*	Nature	Nature of Consideration	Name of the Allottees	Category
August 12, 2016	9,00,000	10	23	Acquisition by Transfer	Cash	Ostwal Phoschem (India) Ltd	Promoter
October 05, 2016	39,00,000	10	23.5	Preferential Allotment	Cash	Ostwal Phoschem (India) Ltd.	Promoter

\*The maximum and minimum price at which the aforesaid transaction was made is Rs. 23.50/- and Rs. 23/- per Equity Share



**9. Details of the Pre and Post Offer Shareholding of our Promoter and Promoter Group as on the date of the Prospectus is as below:-**

S.No	Names	Pre Offer		Post Offer	
		Shares Held	% Shares Held	Shares Held	% Shares Held
<b>Promoter</b>					
1.	Praveen Ostwal	6,78,500	2.73	6,78,500	2.73
2.	Seasons Agro Chem India Private Ltd.	23,87,500	9.59	12,60,250	5.06
3.	Ostwal Phoschem (India) Limited	97,66,500	39.22	97,66,500	39.22
<b>TOTAL (A)</b>		<b>1,28,32,500</b>	<b>51.54</b>	<b>1,17,05,250</b>	<b>47.01</b>
<b>Promoter Group</b>					
4.	Pankaj Ostwal	5,40,000	2.17	5000	0.02
5.	Nitu Ostwal	4,72,500	1.90	2500	0.01
6.	Ekta Jain	4,80,000	1.93	5000	0.02
7.	Madhya Bharat Agro Products Ltd.	17,85,000	7.17	--	--
8.	Chunri Prints Pvt. Ltd.	8,88,000	3.57	5,88,000	2.36
9.	Paneri Textiles Private Limited	8,24,250	3.31	5,24,250	2.11
10.	M/s Mahendra Kumar Ostwal HUF	5,52,500	2.22	2500	0.01
11.	M/s Pankaj Ostwal HUF.	3,00,000	1.20	5000	0.02
12.	M/s Praveen Ostwal HUF	3,00,000	1.20	5000	0.02
13.	Mahendra Kumar Ostwal	85,000	0.34	5000	0.02
14.	Archid Products Pvt. Ltd.	17,71,500	7.11	14,07,750	5.65
<b>TOTAL (B)</b>		<b>79,98,750</b>	<b>32.12</b>	<b>25,50,000</b>	<b>10.24</b>
<b>GRAND TOTAL (A+B)</b>		<b>2,08,31,250</b>	<b>83.66</b>	<b>1,42,55,250</b>	<b>57.25</b>

**10. Details of Promoter's Contribution locked in for three years:**

Date of Allotment / transfer of fully paid up Shares	Date when made Fully paid up	Nature of Allotment/ Acquired/Transfer	No. of shares Allotted/ Acquired Transferred	Face Value (Rs.)	Issue Price/ Transfer Price (Rs.)	% of Pre Offer Shareholding	% of Post Offer Shareholding	Lock in Period
<b>Ostwal Phoschem (India) Limited</b>								
17.11.2014	17.11.2014	Preferential Allotment	30,00,000	10	20	12.05	12.05	3 Years
24.03.2015	24.03.2015	Acquisition by Transfer	12,01,500	10	20	4.83	4.83	3 Years
<b>Sub Total</b>			<b>42,01,500</b>			<b>16.87</b>	<b>16.87</b>	
<b>Praveen Ostwal</b>								
06.06.2007	06.06.2007	Acquisition by Transfer	75000	10	10	0.30	0.30	3Years
02.12.2011	02.12.2011	Acquisition by Transfer	2,45,000	10	10	0.98	0.98	3Years
27.12.2011	27.12.2011	Bonus	1,60,000	10	----	0.64	0.64	3 Years
15.10.2013	15.10.2013	Acquisition by Transfer	1,98,500	10	17	0.80	0.80	3 Years
<b>Sub Total</b>			<b>6,78,500</b>			<b>2.72</b>	<b>2.72</b>	
<b>Seasons Agro Chem India Pvt. Ltd.</b>								
06.06.2007	06.06.2007	Acquisition by Transfer	1,06,500	10	10	0.43	0.43	3 Years
30.09.2011	30.09.2011	Allotment	1,13,500	10	10	0.46	0.46	3 Years

<b>Sub Total</b>	<b>2,20,000</b>	<b>0.88</b>	<b>0.88</b>
<b>Grand Total</b>	<b>51,00,000</b>	<b>20.48</b>	<b>20.48</b>

The minimum Promoter's contribution has been brought in to the extent of not less than the specified minimum lot and from persons defined as "promoter" under the SEBI ICDR Regulations. All Equity Shares, which are being locked in are not ineligible for computation of Minimum Promoters Contribution as per Regulation 33 of the SEBI ICDR Regulations and are being locked in for 3 years as per Regulation 36(a) of the SEBI ICDR Regulations i.e. for a period of three years from the date of allotment of Equity Shares in this Offer.

No Equity Shares proposed to be locked-in as Minimum Promoters Contribution have been issued out of revaluation reserve or for consideration other than cash and revaluation of assets or capitalization of intangible assets, involved in such transactions.

The entire pre-Offer shareholding of the Promoters, other than the Minimum Promoters contribution which is locked in for three years and shares offered in Offer for sale, shall be locked in for a period of one year from the date of allotment in this Offer.

Our Promoter and Promoters Company Mr. Praveen Ostwal, Seasons Agro Chem India Pvt. Ltd. and Ostwal Phoschem (India) Limited have, by a written undertaking, consented to have 51,00,000 Equity Shares held by them respectively to be locked in as Minimum Promoters Contribution for a period of three years from the date of allotment in this Offer and will not be disposed / sold / transferred by the promoters during the period starting from the date of filing this Prospectus with SME Platform of NSE till the date of commencement of lock-in period as stated in this Prospectus. The Equity Shares under the Promoters contribution will constitute 20.48 % of our post-Offer paid up share capital.

Our Promoters have also consented that the Promoters contribution under Regulation 32 of the SEBI ICDR Regulations will not be less than 20% of the post Offer paid up capital of our Company.

**Eligibility of Share for "Minimum Promoters Contribution in terms of clauses of Regulation 33 (1) of SEBI (ICDR) Regulations, 2009**

<b>Reg. No.</b>	<b>Promoters' Minimum Contribution Conditions</b>	<b>Eligibility Status of Equity Shares forming part of Promoter's Contribution</b>
33(1) (a) (i)	Specified securities acquired during the preceding three years, if they are acquired for consideration other than cash and revaluation of assets or capitalization of intangible assets is involved in such transaction	The Minimum Promoter's contribution does not consist of such Equity Shares which have been acquired for consideration other than cash and revaluation of assets or capitalization of intangible assets. <b><u>Hence Eligible</u></b>
33 (1) (a) (ii)	Specified securities acquired during the preceding three years, resulting from a bonus issue by utilization of revaluation reserves or unrealized profits of the issuer or from bonus issue against Equity Shares which are ineligible for minimum promoters' contribution	The minimum Promoter's contribution does not consist of such Equity Shares. <b><u>Hence Eligible</u></b>
33 (1) (b)	Specified securities acquired by promoters during the preceding one year at a price lower than the price at which specified securities are being offered to public in the initial public offer	The minimum Promoter's contribution does not consist of such Equity Shares. <b><u>Hence Eligible.</u></b>
33 (1) (c)	Specified securities allotted to promoters during the preceding one year at a price less than the issue price, against funds brought in by them during that period, in case of an issuer formed by conversion of one or more partnership firms, where the partners of the erstwhile partnership firms are the promoters of the issuer and there is no change in the management: Provided that specified securities, allotted to promoters against capital existing in such firms for a period of more than one year on a continuous basis, shall be eligible	The minimum Promoter's contribution does not consist of such Equity Shares. <b><u>Hence Eligible.</u></b>
33 (1) (d)	Specified securities pledged with any creditor.	Our Promoter's has not Pledged any shares with

Reg. No.	Promoters' Minimum Contribution Conditions	Eligibility Status of Equity Shares forming part of Promoter's Contribution
		any creditors. Accordingly, the minimum Promoter's contribution does not consist of such Equity Shares. <b>Hence Eligible.</b>

### Details of Share Capital Locked In For One Year

In terms of Regulation 36(b) and 37 of the SEBI ICDR Regulations, in addition to the Minimum Promoters contribution which is locked in for 3 (three) years, as specified above, the entire pre-Offer equity share capital held by promoters and entire pre-Offer capital held by persons other than promoters of our Company i.e. Promoter Group Entities and public shareholders, except the shares offered for sale through the Issue constituting 1,32,24,000 Equity Shares shall be locked in for a period of 1 (one) year from the date of allotment of Equity Shares in this Offer.

The Equity Shares which are subject to lock-in shall carry inscription '**non-transferable**' along with the duration of specified non-transferable period mentioned in the face of the security certificate. The shares which are in dematerialized form, if any, shall be locked-in by the respective depositories. The details of lock-in of the Equity Shares shall also be provided to the Designated Stock Exchange before the listing of the Equity Shares.

### Other requirements in respect of lock-in:

- a) In terms of Regulation 39 of the SEBI ICDR Regulations, the locked in Equity Shares held by the Promoters, as specified above, can be pledged with any scheduled commercial bank or public financial institution as collateral security for loan granted by such bank or institution provided that the pledge of Equity Shares is one of the terms of the sanction of the loan. Provided that securities locked in as minimum promoter contribution may be pledged only if, in addition to fulfilling the above requirements, the loan has been granted by such bank or institution, for the purpose of financing one or more of the objects of the Offer.
- b) In terms of Regulation 40 of the SEBI ICDR Regulations, the Equity Shares held by persons other than the Promoters prior to the Offer may be transferred to any other person holding the Equity Shares which are locked in as per Regulation 36 or 37 of the SEBI ICDR Regulations, subject to continuation of the lock-in in the hands of the transferees for the remaining period and compliance with the SEBI (Substantial Acquisition of Shares and Takeovers) Regulations, 2011, as applicable.

Further in terms of Regulation 40 of the SEBI ICDR Regulations, the Equity Shares held by the Promoters may be transferred to and amongst the Promoter Group or to new promoters or persons in control of the company subject to continuation of the lock-in in the hands of the transferees for the remaining period and compliance with SEBI (Substantial Acquisition of Shares and Takeovers) Regulations, 2011, as applicable.

## 11. Our Shareholding Pattern

The table below represents the shareholding pattern of our Company in accordance with Regulation 31 of the SEBI (Listing Obligations and Disclosure Requirements) Regulations, 2015, as on the date of the Prospectus:

### I – Summary of Shareholding Pattern:-

Category	Category of shareholder	Nos. of share holders	No. of fully paid up equity shares held	No. of Partly paid-up equity shares held	No. of shares underlying Depository Receipts	Total nos. shares held	Shareholding as a % of total no. of shares (calculated as per SCRR, 1957) As a % of (A+B+C2)	Number of Voting Rights held in each class of securities*			No. of Shares Underlying Outstanding convertible securities (including Warrants)	Shareholding, as a % assuming full conversion of convertible securities (as a percentage of diluted share capital) As a % of (A+B+C2)	Number of Locked shares in	Number of Shares pledged or otherwise encumbered	Number of equity shares held in dematerialized form	
								Class Shares of Rs.10/- each^	Equity Shares	Total						
I	II	III	IV	V	VI	VII = IV+V+VI	VIII	IX			X	XI=VII+X	XII	XIII	XIV	
(A)	Promoter & Promoter Group	14	2,08,31,250	-	-	2,08,31,250	83.66	2,08,31,250	-	2,08,31,250	83.66	-	83.66	-	-	2,08,31,250
(B)	Public	5	40,68,750	-	-	40,68,750	16.34	40,68,750	-	40,68,750	16.34	-	16.34	-	-	40,68,750
(C)	Non Promoter-Non Public	-	-	-	-	-	-	-	-	-	-	-	-	-	-	-
(C1)	Shares underlying DRs	-	-	-	-	-	-	-	-	-	-	-	-	-	-	-
(C2)	Shares held by Emp. Trusts	-	-	-	-	-	-	-	-	-	-	-	-	-	-	-
<b>Total</b>		<b>19</b>	<b>2,49,00,000</b>	<b>-</b>	<b>-</b>	<b>2,49,00,000</b>	<b>100.00</b>	<b>2,49,00,000</b>	<b>-</b>	<b>2,49,00,000</b>	<b>100.00</b>	<b>-</b>	<b>100.00</b>	<b>-</b>	<b>-</b>	<b>2,49,00,000</b>

\*As on date of this Prospectus 1 Equity share holds 1 vote.

^ We have only one class of Equity Shares of face value of Rs. 10/- each.

**12. The Top Ten Shareholders of our Company and their Shareholding is set forth below:-**

As on the date of the Prospectus, our Company has 19 (Nineteen) shareholders.

a) Our top ten shareholders as on the date of filing of the Prospectus are as follow:

S.No.	Names	Shares Held (Face Value of Rs. 10 each)	% shares held (% Pre Offer paid up Capital)
1.	Ostwal Phoschem (India) Limited	97,66,500	39.22
2.	Seasons Agro Chem India Pvt. Ltd.	23,87,500	9.59
3.	Madhya Bharat Agro Products Ltd.	17,85,000	7.17
4.	Archid Products Pvt. Ltd.	17,71,500	7.11
5.	Swastik Clothtex Pvt. Ltd.	14,40,000	5.78
6.	Vesta Tex Pvt. Ltd	9,63,750	3.87
7.	Chunri Prints Pvt. Ltd.	8,88,000	3.57
8.	Paneri Textile Pvt. Ltd.	8,24,250	3.31
9.	Shubhlaxmi Tex Fab Pvt. Ltd.	7,65,000	3.07
10.	Praveen Ostwal	6,78,500	2.72
	<b>Total</b>	<b>2,12,70,000</b>	<b>85.42</b>

b) Our top ten shareholders 10 days prior filing of the Prospectus are as follows:

S.No.	Names	Shares Held (Face Value of Rs. 10 each)	% shares held (% Pre Offer paid up Capital)
1.	Ostwal Phoschem (India) Limited	97,66,500	39.22
2.	Seasons Agro Chem India Pvt. Ltd.	23,87,500	9.59
3.	Madhya Bharat Agro Products Ltd.	17,85,000	7.17
4.	Archid Products Pvt. Ltd.	17,71,500	7.11
5.	Swastik Clothtex Pvt. Ltd.	14,40,000	5.78
6.	Vesta Tex Pvt. Ltd	9,63,750	3.87
7.	Chunri Prints Pvt. Ltd.	8,88,000	3.57
8.	Paneri Textile Pvt. Ltd.	8,24,250	3.31
9.	Shubhlaxmi Tex Fab Pvt. Ltd.	7,65,000	3.07
10.	Praveen Ostwal	6,78,500	2.72
	<b>Total</b>	<b>2,12,70,000</b>	<b>85.42</b>

c) \*Details of top ten shareholders of our Company two years prior to the date of filing of the Prospectus are as follows:

S.No.	Names	Shares Held (Face Value of Rs. 10 each)	% of Paid Up Equity Shares as on 2 years prior to the date of filing of the Prospectus
1.	Seasons Agro Chem India Pvt. Ltd.	35,57,500	16.94
2.	Ostwal Phoschem India Ltd.	30,00,000	14.29
3.	Madhya Bharat Agro Products Ltd.	17,85,000	8.50
4.	Archid Products Pvt. Ltd.	17,71,500	8.44
5.	Swastik Clothtex Pvt. Ltd.	14,40,000	6.86
6.	Vesta Tex Prints Pvt. Ltd.	9,63,750	4.59
7.	Chunri Prints Pvt. Ltd.	9,19,500	4.38
8.	Paneri textiles Pvt. Ltd.	8,24,250	3.93
9.	Shubhlaxmi Tex Fab Pvt. Ltd.	7,65,000	3.64
10.	Praveen Ostwal	6,78,500	3.23
	<b>Total</b>	<b>1,57,05,000</b>	<b>74.76</b>

\*Details of shares held on November 30, 2014 and Percentage held has been calculated based on the paid up capital of our company as on November 30, 2014

13. Except as disclosed below, none of our public shareholders are holding more than 1% of the pre –offer share capital of our company.

S.No	Names	Pre Offer		Post Offer	
		Shares Held	% Shares Held	Shares Held	% Shares Held
1.	Vesta Tex Pvt. Ltd.	9,63,750	3.87	9,63,750	3.87
2.	Shubhlaxmi Tex Fab Pvt Ltd	7,65,000	3.07	7,65,000	3.07
3.	Suswani Textiles Pvt. Ltd.	5,07,000	2.04	5,07,000	2.04
4.	Swastik Clothtex Pvt. Ltd.	14,40,000	5.78	14,40,000	5.78
5.	Visualize Tradecom Pvt. Ltd.	3,93,000	1.58	3,93,000	1.58
<b>TOTAL (C)</b>		<b>40,68,750</b>	<b>16.34</b>	<b>40,68,750</b>	<b>16.34</b>

14. Except as provided below, no subscription to or sale or purchase of the securities of our Company within three years preceding the date of filing of the Prospectus by our Promoters or Directors or Promoter Group which in aggregate equals to or is greater than 1% of the pre- Offer share capital of our Company.

S. No.	Name of Shareholder	Date of Transaction	Promoter/ Promoter Group/ Director	Number of Equity Shares subscribed to/Acquired	Number of Equity Shares Sold	Subscribed/ Acquired/ Transferred
1.	Ostwal Phoschem (India) Ltd.	17.11.2014	Promoter	30,00,000	--	Subscribed
		24.03.2015	Promoter	11,70,000	--	Acquired
		24.03.2015	Promoter	31,500	--	Acquired
		30.03.2016	Promoter	7,65,000	--	Acquired
		12.08.2016	Promoter	9,00,000	-	Acquired
		05.10.2016	Promoter	39,00,000	--	Subscribed
2.	Seasons Agro Chem India Pvt. Ltd.	24.03.2015	Promoter		(11,70,000)	Transfer

15. None of our Directors or Key Managerial Personnel hold any Equity Shares other than as set out below:

Name	Designation	No. of Equity Shares held
Mr. Praveen Ostwal	Chairman & Managing Director	6,78,500

16. None of our Promoters, Promoter Group, Directors and their relatives has entered into any financing arrangement or financed the purchase of the Equity Shares of our Company by any other person during the period of six months immediately preceding the date of filing of the Prospectus.
17. Neither, we nor our Promoters, Directors, Selling Shareholders and the Lead Manager to this Offer have entered into any buyback and / or standby arrangements and / or similar arrangements for the purchase of our Equity Shares from any person.
18. As on the date of filing of the Prospectus, there are no outstanding warrants, options or rights to convert debentures, loans or other instruments which would entitle Promoters or any shareholders or any other person, any option to acquire our Equity Shares after this Initial Public Offer.
19. As on the date of the Prospectus, the entire Issued Share Capital, Subscribed and Paid up Share Capital of our Company is fully paid up.
20. Our Company has not raised any bridge loan against the proceeds of the Offer.
21. Since the entire Offer price per share is being called up on application, all the successful applicants will be allotted fully paid-up shares.
22. As on the date of the Prospectus, none of the shares held by our Promoters / Promoters Group are subject to any pledge.

23. The Lead Manager i.e. Hem Securities Ltd. and their associates do not hold any Equity Shares in our Company as on the date of filing of the Prospectus.
24. We here by confirm that there will be no further issue of capital whether by way of issue of bonus shares, preferential allotment, rights issue or in any other manner during the period commencing from the date of the Prospectus until the Equity Shares offered have been listed or application moneys refunded on account of failure of Offer.
25. Our Company does not presently intend or propose to alter its capital structure for a period of six months from the date of opening of the Offer, by way of split or consolidation of the denomination of Equity Shares or further issue of Equity Shares (including issue of securities convertible into or exchangeable, directly or indirectly for Equity Shares) whether preferential or otherwise. This is except if we enter into acquisition or joint ventures or make investments, in which case we may consider raising additional capital to fund such activity or use Equity Shares as a currency for acquisition or participation in such joint ventures or investments
26. None of our Equity Shares have been issued out of revaluation reserve created out of revaluation of assets.
27. An over-subscription to the extent of 1% of the total Offer can be retained for the purpose of rounding off to the nearest integer during finalizing the allotment, subject to minimum allotment, which is the minimum application size in this Offer. Consequently, the actual allotment may go up by a maximum of 1% of the Offer. In such an event, the Equity Shares held by the Promoter is used for allotment and lock- in for three years shall be suitably increased; so as to ensure that 20% of the post Offer paid-up capital is locked in.
28. Under subscription, if any, in any of the categories, would be allowed to be met with spill-over from any of the other categories or a combination of categories at the discretion of our Company in consultation with the LM and Designated Stock Exchange i.e. NSE. Such inter-se spill over, if any, would be affected in accordance with applicable laws, rules, regulations and guidelines.
29. In case of over-subscription in all categories the allocation in the Offer shall be as per the requirements of Regulation 43 (4) of SEBI (ICDR) Regulations, 2009 and its amendments from time to time.
30. The unsubscribed portion in any reserved category (if any) may be added to any other reserved category.
31. The unsubscribed portion if any, after such inter se adjustments among the reserved categories shall be added back to the net offer to the public portion.
32. At any given point of time there shall be only one denomination of the Equity Shares, unless otherwise permitted by law.
33. Our Company shall comply with such disclosure and accounting norms as may be specified by NSE, SEBI and other regulatory authorities from time to time.
34. As on the date of the Prospectus, Our Company has not issued any equity shares under any employee stock option scheme and we do not have any Employees Stock Option Scheme / Employees Stock Purchase Scheme.
35. There are no Equity Shares against which depository receipts have been issued.
36. Other than the Equity Shares, there is no other class of securities issued by our Company as on date of filing of the Prospectus.
37. We have 19 (Nineteen) Shareholders as on the date of filing of the Prospectus.
38. There are no safety net arrangements for this Public Offer.
39. Our Promoters and Promoter Group will not participate in this Offer except for the sale of Equity Shares offered by them for sale in the Offer.
40. This Offer is being made through Fixed Price method.
41. Except as disclosed in the Prospectus, our Company has not made any public issue or rights issue of any kind or class of securities since its incorporation to the date of the Prospectus.

42. No person connected with the Offer shall offer any incentive, whether direct or indirect, in the nature of discount, commission, and allowance, or otherwise, whether in cash, kind, services or otherwise, to any Applicant.
43. We shall ensure that transactions in Equity Shares by the Promoters and members of the Promoter Group, if any, between the date of registering the Prospectus with the RoC and the Offer Closing Date are reported to the Stock Exchanges within 24 hours of such transactions being completed. The Selling Shareholders shall not transfer their Equity Shares during the period commencing from submission of the Prospectus with Stock Exchange until the final approval on Basis of Allotment has been obtained from the Stock Exchange for the Equity Shares Allotted/ to be Allotted pursuant to the Offer except for transfer the Equity Shares held by them to demat escrow account at least seven working days prior to Offer Opening Date or as mutually agreed between our Company, Selling Shareholder and the Lead Manager.
44. In terms of Rule 19(2)(b)(i) of the Securities Contracts (Regulation) Rules, 1957, as amended, (the SCRR) the Offer is being made for at least 25% of the post-Offer paid-up Equity Share capital of our Company. Further, this Offer is being made in terms of Chapter XB of the SEBI (ICDR) Regulations, 2009, as amended from time to time.
45. As per RBI regulations, OCB's are not allowed to participate in the Offer
46. Allocation to all categories shall be made on a proportionate basis subject to valid applications received at or above the Offer Price. Under subscription, if any, in any of the categories, would be allowed to be met with spill-over from any of the other categories or a combination of categories at the discretion of our Company in consultation with the Lead Manager and NSE. Such inter-se spill over, if any, would be affected in accordance with applicable laws, rules, regulations and guidelines.
47. The details of equity shares being offered for sale are as follows:

Sr. No.	Name of Selling Shareholder	Number of Equity Shares
1.	Mahendra Kumar Ostwal	80,000
2.	Pankaj Ostwal HUF	295,000
3.	Praveen Ostwal HUF	295,000
4.	Chunri Prints Pvt. Ltd.	300,000
5.	Paneri Textiles Pvt. Ltd	300,000
6.	Archid Products Pvt. Ltd.	363,750
7.	Mrs. Nitu Ostwal	470,000
8.	Mrs. Ekta Jain	475,000
9.	Mr. Pankaj Ostwal	535,000
10.	Mahendra Kumar Ostwal HUF	550,000
11.	Seasons Agro Chem India Pvt. Limited	11,27,250
12.	Madhya Bharat Agro Products Limited	17,85,000
	<b>Total</b>	<b>65,76,000</b>



## OBJECTS OF THE OFFER

The objects of the Offer are to achieve the benefits of listing the Equity Shares on the Stock Exchange and to carry out the sale of 65,76,000 Equity Shares of our Company by the Selling Shareholders at an Offer Price of ₹ 30.00 per Equity Share

### **Offer for Sale**

Each of the Selling Shareholders will be entitled to their respective portion of the proceeds of the Offer for Sale. We will not receive any proceeds from the Offer for Sale. All expenses in relation to the Offer will be shared amongst the Selling Shareholders in accordance with applicable law.

We confirm that the activities we have been carrying out until now are in accordance with the objects clause of our Memorandum of Association.

The listing of the Equity Shares will provide liquidity to the existing shareholders and will also create a public trading market for the Equity Shares of our Company.

### **1. Offer Expenses**

The total expenses of the Offer are estimated to be approximately ₹ 28.00 Lacs. The estimated Offer related expenses include, among others, Offer management fees, underwriting and selling commissions, printing and distribution expenses, legal fees, advertisement expenses, registrar's fees, depository fees and listing fees and Advisory fee. All expenses in relation to the Offer will be paid and shared between the Company & Selling shareholders except listing fees and Advisory fee which will be paid by the Company.

In accordance with Section 28(3) of the Companies Act, 2013, the Selling Shareholders have authorized our Company to take all actions in respect of offer of sale for and on their behalf and they will reimburse our Company all expenses incurred by the Company on this matter. The break-up for the estimated Offer expenses are as follows:

<b>Particulars</b>	<b>Expenses</b>	<b>As a % of total expenses</b>	<b>As a % of Offer</b>
Payment to Merchant Banker including, underwriting and selling commissions, brokerages, payment to other intermediaries such as Legal Advisors etc. and other out of pocket expenses.	21.00	75.00%	1.06%
Printing & Stationery & Advertising Expenses etc.	4.00	14.28%	0.20%
Statutory & Regulatory Fees and other expenses	3.00	10.72%	0.15%
<b>Total estimated Offer Expenses*</b>	<b>28.00</b>	<b>100.00%</b>	<b>1.41%</b>

\* All expenses in relation to the Offer will be shared amongst Company & Selling Shareholders in accordance with applicable law.

\*Included Commission/ processing fees for SCSB, Brokerage and selling commission for Registered Brokers, RTA's and CDPs

### **Monitoring Utilization of Funds**

Since the Offer is being made through an offer for sale our Company will not receive any proceeds from the Offer. Therefore our Company is not required to appoint a monitoring agency for the Offer.

## BASIC TERMS OF OFFER

### Authority for the Offer

The Offer for sale has been authorized by a resolution of the Board of Directors of the Company passed at their meeting held on December 14, 2016 and shareholders in Extra-ordinary General Meeting held on December 19, 2016. The Selling Shareholders have authorized the sale of their Equity Shares pursuant to the Offer as set out below:

Sr. No.	Name of Selling Shareholder	Date of Authorization Letter	Number of Equity Shares offered for sale
1.	Mahendra Kumar Ostwal	December 12, 2016	80,000
2.	Pankaj Ostwal HUF	December 12, 2016	295,000
3.	Praveen Ostwal HUF	December 12, 2016	295,000
4.	Chunri Prints Pvt. Ltd.	December 12, 2016	300,000
5.	Paneri Textiles Pvt. Ltd	December 12, 2016	300,000
6.	Archid Products Pvt. Ltd.	December 12, 2016	363,750
7.	Mrs. Nitu Ostwal	December 12, 2016	470,000
8.	Mrs. Ekta Jain	December 12, 2016	475,000
9.	Mr. Pankaj Ostwal	December 12, 2016	535,000
10.	Mahendra Kumar Ostwal HUF	December 12, 2016	550,000
11.	Seasons Agro Chem India Pvt. Limited	December 12, 2016	11,27,250
12.	Madhya Bharat Agro Products Limited	December 12, 2016	17,85,000
<b>Total</b>			<b>65,76,000</b>

The Selling Shareholders have severally confirmed that the Equity Shares proposed to be offered and sold in the Offer are eligible in term of SEBI (ICDR) Regulations and that they have not been prohibited from dealings in securities market and the Equity Shares offered and sold are free from any lien, encumbrance or third party rights. The Selling Shareholders have also severally confirmed that they are the legal and beneficial owners of the Equity Shares being offered by them under the Offer.

### Terms of the Offer

The Equity Shares, being offered, shall be subject to the provisions of the Companies Act, ICDR Regulations, SCRA, SCRR, the Memorandum and Articles of Association, the terms and conditions of the Prospectus, Prospectus, Application form, Confirmation of Allocation Note (“CAN”), the guidelines for listing of securities issued by the Government of India and the Depositories Act, Stock Exchange, RBI, RoC and/or other authorities as in force on the date of the Offer and to the extent applicable.

In addition, the Equity Shares shall also be subject to such other conditions as may be incorporated in the Share Certificates, as per the SEBI (ICDR) Regulations, 2009, notifications and other regulations for the issue of capital and listing of securities laid down from time to time by the Government of India and/or other authorities and other documents that may be executed in respect of the Equity Shares.

<b>Face Value</b>	Each Equity Share shall have the face value of ₹ 10.00 each.
<b>Offer Price</b>	Each Equity Share is being offered at a price of ₹ 30.00 each and is 3.00 times of Face Value.
<b>Market Lot and Trading Lot</b>	The Market lot and Trading lot for the Equity Share is 4000 and the multiple of 4000; subject to a minimum allotment of 4000 Equity Shares to the successful Applicant.
<b>Terms of Payment</b>	100% of the Offer price of ₹ 30.00 per share shall be payable on Application. For more details please refer “Terms of the Offer” beginning to page 244 of the Prospectus.
<b>Ranking of the Equity Shares</b>	The Equity Shares being offered pursuant to this Offer shall be subject to the provisions of Companies Act, Memorandum and Articles of Association of the Company and shall rank pari passu in all respects including dividends with the existing Equity Shares of the Company. The Allottees in receipt of Allotment of Equity Shares under this Offer will be entitled to dividends and other corporate benefits, if any, declared by the Company after the date of Allotment. For further details, please see “Main Provisions of the Articles of Association” on page 294 of the Prospectus.

### **Minimum Subscription**

In accordance with Regulation [106P] (1) of SEBI ICDR Regulations, this Offer is 100% underwritten. Also, in accordance with explanation to Regulation [106P] (1) of SEBI ICDR Regulations the underwriting shall not be restricted up to the minimum subscription level.

If our Company does not receive subscription of 100% of the Offer including devolvement of Underwriters within 60 (Sixty) days from the date of closure of the Offer, our Company shall forthwith refund the entire subscription amount received. If there is a delay beyond the prescribed time, our Company shall pay interest prescribed in the Companies Act, the SEBI (ICDR) Regulations and other applicable Laws, if any.

Further, In accordance with Regulation [106R] of SEBI ICDR Regulations, No allotment shall be made pursuant to the Offer, if the number of prospective allottees is less than 50 (fifty).

For further details, please refer to section titled "Terms of the Offer" beginning on page 244 of the Prospectus.

### BASIS FOR OFFER PRICE

Investors should read the following summary with the section titled “Risk Factors”, the details about our Company under the section titled “Our Business” and its financial statements under the section titled “Financial Information of the Company” beginning on page 16, page 91 and page 157 respectively of the Prospectus. The trading price of the Equity Shares of our Company could decline due to these risks and the investor may lose all or part of his investment.

The Offer Price has been determined by the Company and the Selling Shareholders in consultation with the LM on the basis of the key business strengths of our Company. The face value of the Equity Shares is Rs. 10 and Offer Price is 30.00 which is 3.00 times of the face value.

### QUALITATIVE FACTORS

- Cost Effective sourcing and Strategic Location of Manufacturing Unit
- Quality Assurance
- Leveraging the expertise of our Promoters and Management Team
- Forward integration
- Existing relationship with suppliers

For a detailed discussion on the qualitative factors which form the basis for computing the price, please refer to sections titled “Our Business” beginning on page no 91 of the Prospectus.

### QUANTITATIVE FACTORS

Information presented below is derived from our Company’s Restated Financial Statements prepared in accordance with Indian GAAP. Some of the quantitative factors, which form the basis for computing the price, are as follows:

#### 1. Basic & Diluted Earnings per share (EPS), as restated:

S. No	Period	Basic & Diluted (₹)	Weights
1.	FY 2013-14	2.80	1
2.	FY 2014-15	1.53	2
3.	FY 2015-16	1.50	3
	<b>Weighted Average</b>	<b>1.73</b>	<b>6</b>
	<b>For 8 Months period ended November 30, 2016*</b>	<b>1.79</b>	

\*Not Annualized

Notes:

- i. The figures disclosed above are based on the restated financial statements of the Company.
- ii. The face value of each Equity Share is ₹ 10.00.
- iii. Earnings per Share has been calculated in accordance with Accounting Standard 20 – “Earnings per Share” issued by the Institute of Chartered Accountants of India.
- iv. The above statement should be read with Significant Accounting Policies and the Notes to the Restated Financial Statements as appearing in Annexure IV.

#### 2. Price Earning (P/E) Ratio in relation to the Offer Price of ₹ 30.00 per share:

S. No	Particulars	P/E
1	P/E ratio based on the Basic & Diluted EPS, as restated for FY 2015-16	19.98
2	P/E ratio based on the Weighted Average EPS, as restated for FY 2015-16	17.36
3	P/E ratio based on the Basic & Diluted EPS, as restated for Period ended November 30, 2016	16.76

## Peer Group P/ E\*

S. No	Particulars	P/E
1	Highest (Khaitan Chemicals & Fertilizers Ltd.)	89.80
2	Lowest (Gujarat Narmada Valley Fertilizers & Chemicals Ltd.)	9.80
<b>Industry Composite</b>		20.69

\*Source: AceEquity dated February 02, 2017

## Return on Net worth (RoNW)\*

S. No	Period	RONW (%)	Weights
1.	FY 2013-14	15.47%	1
2.	FY 2014-15	7.06%	2
3.	FY 2015-16	7.06%	3
<b>Weighted Average</b>		<b>8.46%</b>	
<b>For 8 Months period ended November 30, 2016<sup>#</sup></b>		<b>6.80%</b>	

\*Restated Profit after tax/Net Worth

<sup>#</sup> Not Annualized

## 4. Minimum Return on Net Worth after Offer to maintain Pre- Offer EPS

(a) Based on Basic and Diluted EPS, as restated of FY 2015-16 of ₹ 1.50 at the Offer Price of ₹ 30.00 per share:

- 6.48% on the restated financial statements.

(b) Based on Weighted Average Basic and Diluted EPS, as adjusted of ₹ 1.73 at the Offer Price of ₹ 30.00 per share:

- 7.46% on the restated financial statements.

## 5. Net Asset Value (NAV) per Equity Share :

Sr. No.	As at	NAV (₹)
1.	March 31, 2014	18.11
2.	March 31, 2015	19.75
3.	March 31, 2016	21.25
4.	November 30, 2016*	23.18
5.	NAV after Offer	23.18
<b>Offer Price</b>		30.00

\* Net Asset Value per Share for 8 months period ended November 30, 2016 has been computed considering the outstanding number of shares as on November 30, 2016.

6. Comparison of Accounting Ratios with Industry Peers<sup>1</sup>

S. No.	Name of Company	Results Type	Face Value (₹)	EPS (₹) <sup>3</sup>	PE <sup>4</sup>	RoNW (%)	NAV per Share (₹)
1.	Rama Phosphates Limited	Standalone	10.00	3.60	23.99	6.79	70.86
2.	Aries Agro Ltd.	Consolidated	10.00	6.92	24.36	4.49	149.98
3.	Coromandel International Ltd.	Consolidated	1.00	14.59	22.68	15.60	96.85
4.	Krishana Phoschem Limited <sup>2</sup>	Standalone	10.00	1.50	19.98	7.06	21.25

<sup>1</sup> \*Source: AceEquity dated February 02, 2017

<sup>2</sup> Based on March 31, 2016 restated financial statements

<sup>3</sup> Basic & Diluted Earnings per share (EPS), as adjusted

<sup>4</sup> Price Earning (P/E) Ratio in relation to the Offer Price of ₹30.00 per share.

7. The face value of our shares is ₹ 10.00 per share and the Offer Price is of ₹ 30.00 per share which is 3.00 times of the face value.
8. Our Company and Selling Shareholders in consultation with the Lead Manager believe that the Offer Price of ₹ 30.00 per share for the Public Offer is justified in view of the above parameters. The investors may also want to peruse the risk factors and financials of the Company including important profitability and return ratios, as set out in the Auditors' Report in the offer Document to have more informed view about the investment.

Investors should read the above mentioned information along with section titled "Our Business", "Risk Factors" and "Financial Information of the Company" beginning on page 91, 16 and 157 respectively including important profitability and return ratios, as set out in "Annexure Q" to the Financial Information of the Company on page 185 of the Prospectus to have a more informed view.

**STATEMENT OF TAX BENEFITS**

To,

**The Board of Directors,  
Krishana Phoschem Limited,  
5-O-20, Basement R.C. Vyas Colony  
Bhilwara – 311001, Rajasthan, India**

Dear Sir,

**Subject: Statement of possible tax benefits ('the Statement') available to Krishana Phoschem Limited ("the Company") and its shareholders prepared in accordance with the requirement in SCHEDULE VIII – CLAUSE (VII) (L) of Securities and Exchange Board of India (Issue of Capital Disclosure Requirements) Regulations 2009, as amended ('the Regulation')**

We hereby report that the enclosed annexure prepared by the Company, states the possible special Tax benefits available to the Company and the shareholders of the Company under the Income - Tax Act, 1961 ('Act'), presently in force in India. Several of these benefits are dependent on the Company or its shareholders fulfilling the conditions prescribed under the relevant provisions of the Act. Hence, the ability of the Company or its shareholders to derive the tax benefits is dependent upon fulfilling such conditions which, based on business imperatives, the Company may or may not choose to fulfill.

The benefits discussed in the enclosed Annexure cover only special tax benefits available to the Company and do not cover any general tax benefits available to the Company Further , the preparation of enclosed statement and the contents stated therein is the responsibility of the Company's management. We are informed that, this Statement is only intended to provide general information to the investors and is neither designed nor intended to be a substitute for professional tax advice. In view of the individual nature of the tax consequences and the changing tax laws, each investor is advised to consult his or her own tax consultant with respect to the specific tax implications arising out of their participation in the proposed initial public offering of equity shares ("the Offer") by the Company.

We do not express any opinion or provide any assurance as to whether: a) The Company or its Equity Shareholders will continue to obtain these benefits in future; or b) The conditions prescribed for availing the benefits have been / would be met with. The contents of the enclosed statement are based on information, explanations and representations obtained from the Company and on the basis of our understanding of the business activities and operations of the Company. Our views are based on facts and assumptions indicated to us and the existing provisions of tax law and its interpretations, which are subject to change or modification from time to time by subsequent legislative, regulatory, administrative, or judicial decisions. Any such changes, which could also be retrospective, could have an effect on the validity of our views stated herein. We assume no obligation to update this statement on any events subsequent to its Offer, which may have a material effect on the discussions herein. This report including enclosed annexure are intended solely for your information and for the inclusion in the Draft Prospectus/ Prospectus or any other issue related material in connection with the proposed initial public offer of the Company and is not to be used, referred to or distributed for any other purpose without our prior written consent.

**For M/s Ashok Kanther & Associates  
Chartered Accountants  
Firm Registration No. 050014C**

**CA Ashok Kanther  
Partner  
Membership No. 043571**

**Date: December 22, 2016  
Place: Bhilwara**

## **ANNEXURE TO THE STATEMENT OF POSSIBLE TAX BENEFITS**

*The information provided below sets out the possible special tax benefits available to the Company and the Equity Shareholders under the Income Tax Act 1961 presently in force in India. It is not exhaustive or comprehensive and is not intended to be a substitute for professional advice. Investors are advised to consult their own tax consultant with respect to the tax implications of an investment in the Equity Shares particularly in view of the fact that certain recently enacted legislation may not have a direct legal precedent or may have a different interpretation on the benefits, which an investor can avail.*

YOU SHOULD CONSULT YOUR OWN TAX ADVISORS CONCERNING THE INDIAN TAX IMPLICATIONS AND CONSEQUENCES OF PURCHASING, OWNING AND DISPOSING OF EQUITY SHARES IN YOUR PARTICULAR SITUATION.

### **A. SPECIAL TAX BENEFITS TO THE COMPANY :-**

The Company is eligible for deduction under Section 35AD i.e. an assessee shall be allowed a deduction in respect of the whole of any expenditure of capital nature incurred, wholly and exclusively, for the purposes of any specified business carried on by him during the previous year in which such expenditure is incurred by him. Where the specified business has commenced its operations on or after the 1st day of April, 2012, the deduction under sub-section (1) shall be allowed of an amount equal to one and one-half times of the expenditure referred to therein.

Except as above there is no Special Tax Benefits to the Company.

### **B. SPECIAL TAX BENEFITS TO THE SHAREHOLDER :- NIL**

Note:

1. All the above benefits are as per the current tax laws and will be available only to the sole / first name holder where the shares are held by joint holders.
2. The above statement covers only certain relevant direct tax law benefits and does not cover any indirect tax law benefits or benefit under any other law.
3. No assurance is given that the revenue authorities/courts will concur with the views expressed herein. Our views are based on the existing provisions of law and its interpretation, which are subject to changes from time to time. We do not assume responsibility to update the views consequent to such changes. We do not assume responsibility to update the views consequent to such changes. We shall not be liable to any claims, liabilities or expenses relating to this assignment except to the extent of fees relating to this assignment, as finally judicially determined to have resulted primarily from bad faith or intentional misconduct. We will not be liable to any other person in respect of this statement



**SECTION IV – ABOUT THE COMPANY**

**INDUSTRY OVERVIEW**

The information in this section has been extracted from various websites and publicly available documents from various industry sources. The data may have been re-classified by us for the purpose of presentation. None of the Company and any other person connected with the Offer have independently verified this information. Industry sources and publications generally state that the information contained therein has been obtained from believed to be reliable, but their accuracy, completeness and underlying assumptions are not guaranteed and their reliability cannot be assured. Industry sources and publications are also prepared based on information as of specific dates and may no longer be current or reflect current trends. Industry sources and publications may also base their information on estimates, projection forecasts and assumptions that may prove to be incorrect. Accordingly, investors should not place undue reliance on information.

**Global economic outlook**

The World Bank is revising its 2016 global economic growth forecast down to 2.4 percent from the 2.9 percent pace projected in January. The move is due to sluggish growth in advanced economies, stubbornly low commodity prices, weak global trade, and diminishing capital flows. Commodity-exporting emerging market and developing economies have struggled to adapt to lower prices for oil and other key commodities. Growth in these economies is projected to advance at a meager 0.4 percent pace this year, whereas growth in commodity importers has been more resilient. Projections are subject to substantial downside risks, including additional growth disappointments in advanced economies or key emerging markets and rising policy and geopolitical uncertainties. In an environment of weak growth and eroding policy buffers, structural reforms have become even more urgent. “Depressed commodity prices have slowed growth sharply in commodity-exporting emerging and developing economies, which are home to more than half the global poor,” said World Bank Group President Jim Yong Kim, “Economic growth remains the most important driver of poverty reduction. This underscores the critical priority of pursuing growth-enhancing policies to eliminate extreme poverty and boost shared prosperity.”

(Source:- <https://www.worldbank.org/en/publication/global-economic-prospects>)

Since the onset of the global financial crisis, developing countries generated much of the global output growth as per below chart. China, in particular, became the locomotive of global growth, contributing nearly one third of world output growth during 2011-2012. As the largest trading nation, China sustained the global growth momentum during the post-crisis period, maintaining strong demand for commodities and boosting export growth in the rest of the world. With a much anticipated slowdown in China and persistently weak economic performances in other large developing and transition economies—notably Brazil and the Russian Federation—the developed economies are expected to contribute more to global growth in the near term, provided they manage to mitigate deflationary risks and stimulate investment and aggregate demand. On the other hand, bottoming-out of the commodity price decline, which will contribute to reducing volatility in capital flows and exchange rates, will help reduce macroeconomic uncertainties and stimulate growth in a number of developing and emerging economies, including in the least developed countries (LDCs). Developing countries are expected to grow by 4.3 per cent and 4.8 per cent in 2016 and 2017, respectively.

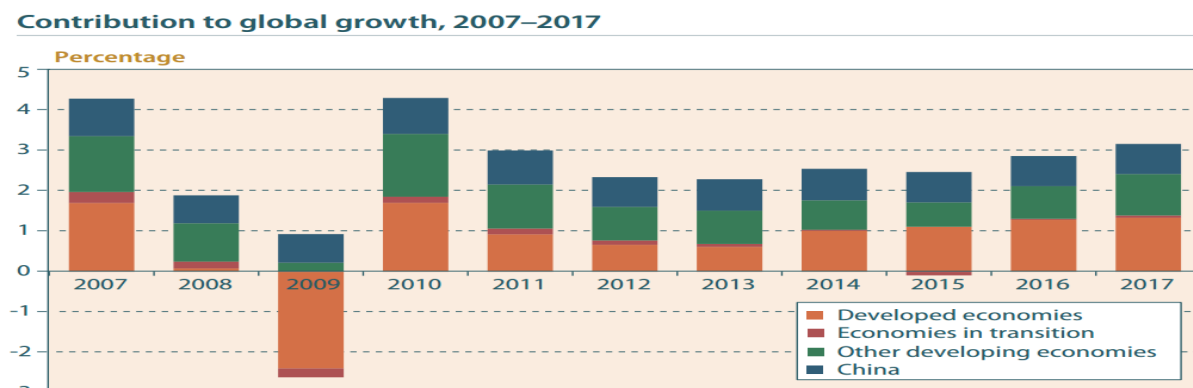

(Source - [http://www.un.org/en/development/desa/policy/wesp/wesp\\_current/2016wesp\\_ch1\\_en.pdf](http://www.un.org/en/development/desa/policy/wesp/wesp_current/2016wesp_ch1_en.pdf))

### Recent Developments: Major Economies

Major advanced economies are at different stages of their post-crisis recovery but are expected to stabilize around a weak growth trajectory. Rising or high public debt and monetary policy rates at or near the zero lower bound could reduce the effectiveness of counter-cyclical policies, leaving these economies more vulnerable to domestic and external shocks. At the same time, declining productivity growth and aging populations exert a more fundamental drag on potential growth

#### A. GDP level

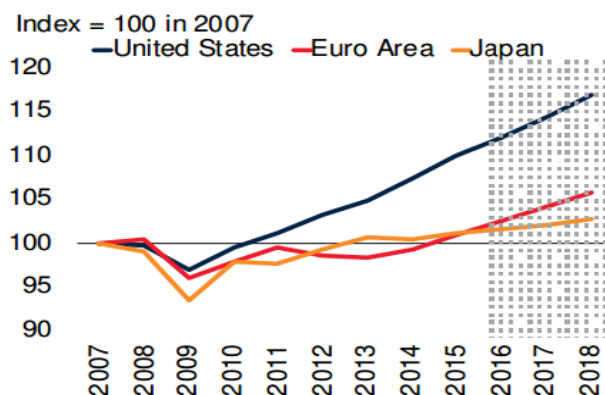

#### B. Public debt and nominal policy rates in G3 countries

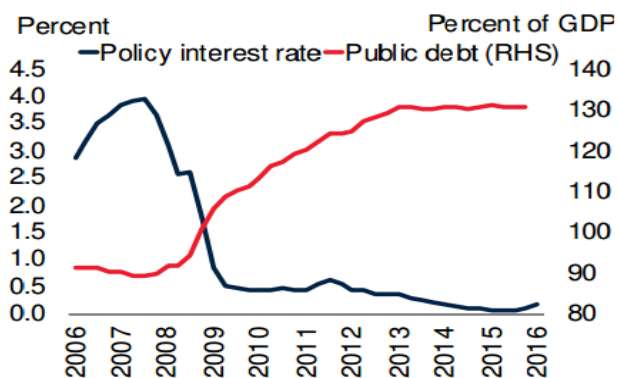

**Financial markets:** Following bouts of volatility at the start of 2016, financial market conditions have improved, but capital flows to emerging and developing economies remain vulnerable to sudden changes in investors’ risk appetite. Oil and, to a lesser degree, other commodity prices fell significantly in early 2016 and, although they have retraced some of their declines, are generally lower than anticipated at the start of the year. Global trade prospects have been significantly downgraded for 2016 and 2017, reflecting a combination of cyclical and structural factors.

**Commodity Markets:** The weakness of commodity prices, especially for energy, persisted into 2016, pushing some prices to new lows at the start of the year. Abundant supplies and stocks across most commodity sectors, softening global growth prospects, and a strong U.S. dollar have all contributed to the weakness. Prices have since generally recovered from their lows, on expectations of reduced supplies going forward, and some short-covering in futures markets. However, most commodity markets remain well supplied with large stocks, making significant price increases unlikely.

**Agricultural Commodity Markets.** Agricultural prices continued their downward trend during the first quarter of 2016, the seventh consecutive quarterly decline. Ample supplies during the current and past two seasons have kept most grain and oilseed markets well-supplied. Since agriculture is an energy intensive sector, weakness in agricultural prices has also reflected the pass-through from lower energy prices. A 10 percent decline in energy prices is associated with a 1.5 to 2 percent decline in agricultural commodity prices. Input costs for agricultural commodities have also eased because policy-driven demand for biofuels, crops that compete with agricultural commodities for land, has leveled off.

### Recent Developments: Emerging market and developing economies

The weakness in emerging market and developing economies in 2015 has extended into 2016. Aggregate growth for EMDEs is projected at 3.5 percent for 2016, marginally above the disappointing pace of 3.4 percent in 2015. However, this forecast masks a marked difference between commodity exporters and importers. After stagnating last year, growth in commodity exporting EMDEs for 2016 is expected to be 0.4 percent—substantially below the 1.6 percent envisaged in January, reflecting further downward revisions to commodity price forecasts, weak global trade, volatile capital flows, and persistent domestic challenges. In contrast, growth projections for commodity importing EMDEs are little changed, at 5.8 percent for 2016, and are expected to be broadly stable at that level through 2018. In low-income countries, growth in 2016 is projected at 5.3 percent. Policy buffers continue to erode in commodity exporting EMDEs, especially in oil exporting countries, reducing their ability to withstand further downside shocks.

**A. Regional growth (weighted average)**

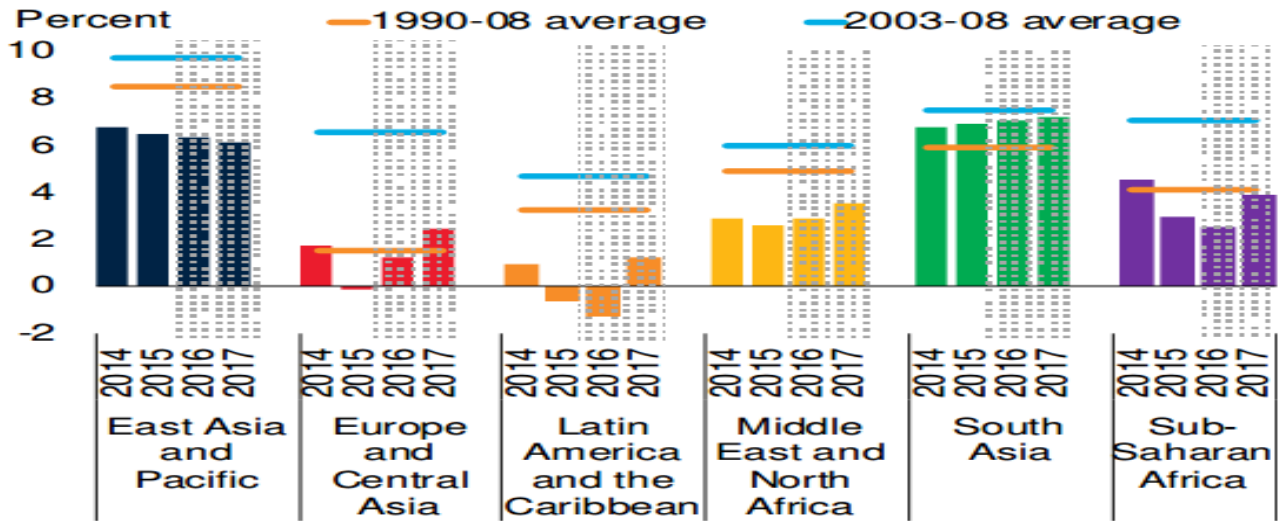

**Regional perspectives:**

**Recent developments and outlook**

Differences in recent developments and prospects across EMDE regions reflect in part the divergences between commodity exporters and importers. Broadly speaking, the 2016 growth forecasts for East Asia and Pacific and South Asia are little changed from the start of the year. In contrast, baseline 2016 forecasts for regions with major commodity exporting economies—Europe and Central Asia, Latin America and the Caribbean, the Middle East and North Africa, and Sub-Saharan Africa—have been downgraded since January.

**Risks to the outlook**

In a weak growth environment, the global economy is facing increasingly pronounced downside risks. These are associated with deteriorating conditions among key commodity exporters, disappointing activity in advanced economies, rising private sector debt in large emerging markets, and heightened policy and geopolitical uncertainties. Other major downside risks over the medium term include increased protectionism and slower catch-up of large emerging markets toward advanced economy income levels. The possibility of delayed benefits from lower energy prices remains an upside risk.

(Source: <http://pubdocs.worldbank.org/en/842861463605615468/Global-Economic-Prospects-June-2016-Divergences-and-risks.pdf>)

**Indian Economy Overview**

**Introduction:**

India is the world’s fastest-growing large economy, having outpaced China over the past year. Yet though economic growth has improved living standards, India, which has the largest number of poor in the world, is still struggling to lift its 1.2 billion population out of poverty. The IMF predicts a robust growth rate of 7.6% for India’s economy in 2016 and 2017.

"India has benefited from lower oil prices and remains the fastest-growing large economy in the world," the IMF said.

However, concerns remain about jobs, which have not kept pace with economic growth. India now ranks 39th among the world’s most competitive economies, up 16 places from last year – the biggest leap for any country in the World Economic Forum’s Global Competitiveness Report 2016-2017.

(Source: <https://www.weforum.org/agenda/2016/10/india-economy-in-numbers/>)

Economic growth is projected to remain strong, hovering around 7.5%. Private consumption will be boosted by expected large increases in public wages and declining inflation. Investment will pick up gradually as excess capacity fades, deleveraging continues for corporations and banks, and infrastructure projects mature.

Inflation is above the long-term target and public debt is high, leaving little room for accommodative policies. However, some monetary impulse is to come as recent cuts in policy rates are passed on to consumers and investors. The renewed commitment for fiscal consolidation is welcome but the quality of public finances should be improved by increasing tax revenue and tilting the spending mix towards physical and social infrastructure. Creating more and better quality jobs is the key to inclusive growth and requires modernizing labour laws and making further progress in the ease of doing business.

Improving productivity is essential for India's GDP per capita to catch up with higher-income countries. In the agriculture sector, which still absorbs about half of total employment, this would require farm consolidation and mechanization as well as better storage and transport infrastructure. In the manufacturing sector, labour and product market regulations should be reformed to enable firms to expand to an efficient size. Providing better access to quality health and education systems is also key, both to raise productivity and to ensure its fruits are spread more equitably.

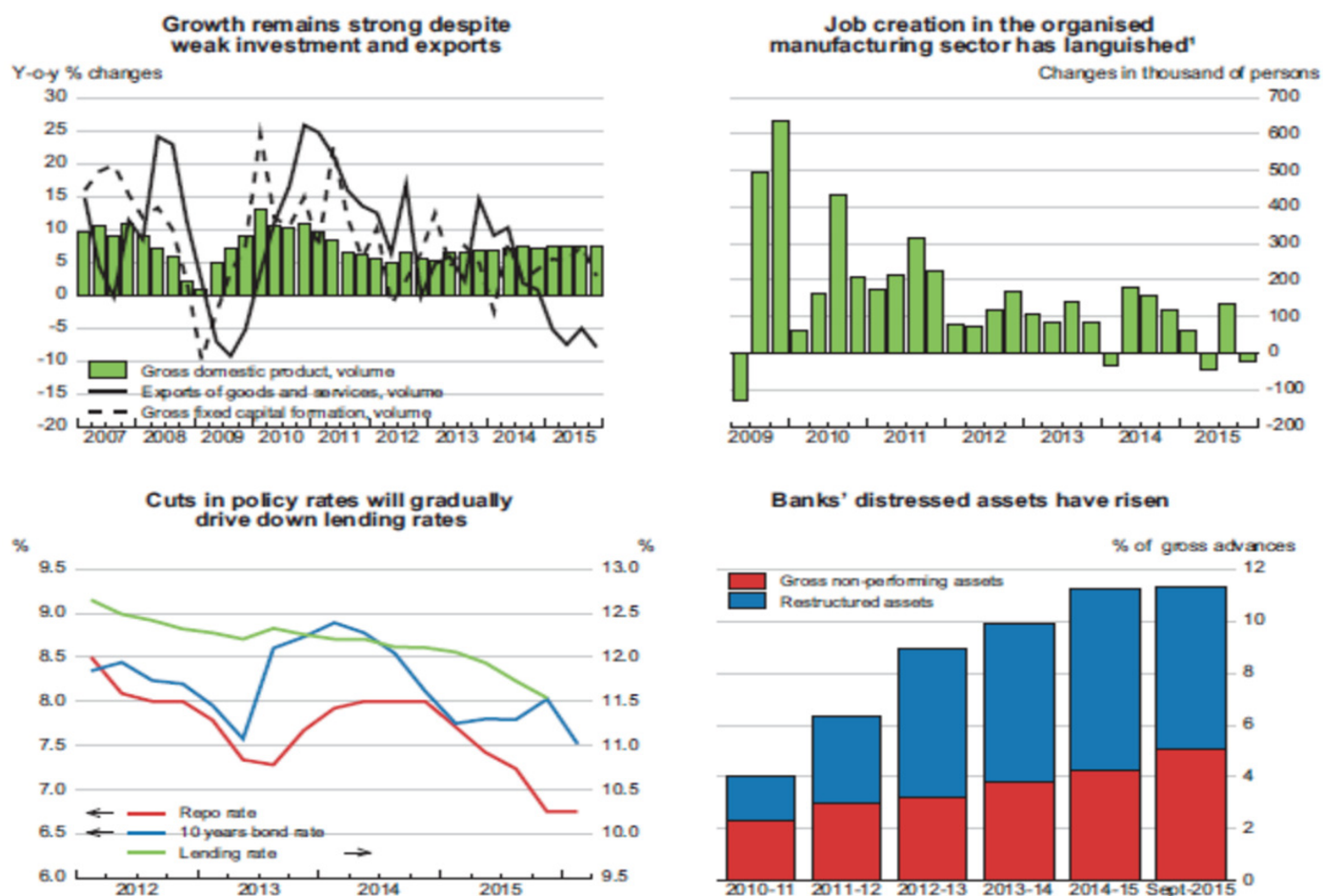

(Source: <http://www.oecd.org/economy/india-economic-forecast-summary.htm>)

**Recent Developments:-**

The Indian economy will continue to post robust growth in the coming years, says the latest India Development Update of the World Bank. The Update also reviews the current challenges in India's financial sector and analyzes some of the impacts of the recommendations of the 14<sup>th</sup> Finance Commission on Indian states.

According to the Update, India’s economy expanded at a faster pace in financial year (FY) 2016 even as a number of its growth engines stalled. Agriculture – having faced two consecutive drought years – rural household consumption, private investments, and exports have not performed to potential. The oil bonanza most directly benefited the government, which for the first time in five years exceeded its revenue collection targets and used the resources to contain the fiscal deficit, transfer more resources to states, and spend more on infrastructure. Capital spending by the central government was ramped up, its efforts amplified by state governments that had additional resources from larger fiscal devolution.

But it was urban households who were the main drivers of growth in FY 2016. The manufacturing and services sectors, which expanded 7.4 and 8.9 percent, respectively, also created urban jobs. Inflation abated, primarily because of lower food prices. Lower inflation raised real incomes, and allowed RBI to cut interest rates, which favored the financially-connected urban households.

To remain on this growth path and sustain growth at 7.6 percent into FY17, the challenge for the Indian economy is to activate the stalled engines – agricultural growth and rural demand; trade; and private investment, while ensuring that demand from urban households and public investments.

The Update, a twice yearly report on the Indian economy and its prospects, expects India’s economic growth to be at 7.6 percent in 2016-2017, followed by a modest acceleration to 7.7 percent in 2017-2018 and 7.8 percent in 2018-2019. According to the Update, the most significant near-and medium-term risks stem from the banking sector and its ability to finance private investment which continues to face several impediments in the form of excess global capacity, regulatory and policy challenges, in addition to corporate debt overhang.

In less than three decades, India’s financial sector has evolved from an essentially state-controlled system toward one with greater participation of private banks and generally more competition. Banks currently have capital levels in excess of regulatory requirements, regulations have been strengthened, and overall credit growth in real terms has been resilient. On the other hand, concerns have arisen about growing non-performing assets (NPAs) and declining credit growth, particularly in public sector banks (PSBs).

The Update suggests two key reform fronts for the financial sector. First, accelerate the ongoing structural transformation of the sector toward one that is more market-oriented and competitive, for example by providing a roadmap for relaxing government mandates on banks. Second, address the NPA challenge, both by its branches (through recapitalization of PSBs and providing tools for banks to manage stressed assets), and its roots (through stronger governance of both commercial banks as well as the corporate sectors that have generated the largest share of NPAs).

An analysis of the FY17 budget documents of 20 states suggests all states gained following the implementation of the 14th FC recommendations in FY16, but the extent of gains varied significantly. Tax devolution increased everywhere, even for states that saw a reduction in their inter-state share, such as Bihar and Rajasthan. Overall, transfer of grants to states increased by 0.7 percent of GDP in FY16 compared to the budget estimate of a net increase of 0.5 percent.

**Health and education expenditures increased in almost every state in FY16.** Combined health and education expenditures increased in 13 of the 14 states for which data was available. Education expenditures generally increased more than health, likely on account of implementation of the Right to Education Act and as states allocated additional amounts to cover lower contributions from the centrally sponsored schemes. On average, states increased health and education expenditures by 0.4 percent of GSDP. **Uttar Pradesh** spent over one-third of its additional resources on health and education. **Rajasthan and Kerala** stand out as spending the equivalent of over 70 percent of additional resources on health, education, and infrastructure.

(Source: <http://www.worldbank.org/en/news/press-release/2016/06/20/manufacturing-and-services-urban-consumption-keep-economy-on-growth-path>)

**Challenges In 2016-17:**

- Risks of further global slowdown and turbulence
- Additional fiscal burden due to 7th Central Pay Commission recommendations and OROP.

**Roadmap & Priorities:**

- ‘Transform India’ to have a significant impact on economy and lives of people.
- Government to focus on –

- ensuring macro-economic stability and prudent fiscal management
- boosting on domestic demand
- Continuing with the pace of economic reforms and policy initiatives to change the lives of our people for the better.
- Focus on enhancing expenditure in priority areas of - farm and rural sector, social sector, infrastructure sector employment generation and recapitalisation of the banks.
- Focus on Vulnerable sections through:
  - Pradhan Mantri Fasal Bima Yojana
  - New health insurance scheme to protect against hospitalisation expenditure
  - facility of cooking gas connection for BPL families
- Continue with the ongoing reform programme and ensure passage of the Goods and Service Tax bill and Insolvency and Bankruptcy law
- Undertake important reforms by:
  - giving a statutory backing to AADHAR platform to ensure benefits reach the deserving.
  - freeing the transport sector from constraints and restrictions
  - incentivising gas discovery and exploration by providing calibrated marketing freedom
  - enactment of a comprehensive law to deal with resolution of financial firms
  - provide legal framework for dispute resolution and re-negotiations in PPP projects and public utility contracts
  - undertake important banking sector reforms and public listing of general insurance companies undertake significant changes in FDI policy.

#### Government Initiatives:-

- 'Social Sector', is one of the nine distinct pillars of the transformative agenda of the Union Budget 2016-17. The Budget has a special focus on the vulnerable sections of the society. This could be noticed from the Budget Speech of the Finance Minister (FM). In addition to some on-going important social sector schemes, especially those for the minorities, the major new initiatives announced for social sector by the FM are:
- LPG connection to rural households in Mission Mode
- a new health protection scheme to provide health cover up to Rs. 1 lakh per family with additional top-up package up to Rs. 30000 for senior citizens of 60 years and above
- "National Dialysis Services Programme" to provide dialysis services in all district hospitals under the National Health Mission
- supply of generic drugs through new 3000 stores under Prime Minister's Jan Aushadhi Yojana to make available quality medicines at affordable prices
- a new "Stand Up India Scheme" with allocation of Rs. 500 crore to promote entrepreneurship amongst SCs, STs and women
- National Scheduled Castes and Scheduled Tribes Hubs in partnership with Industry associations to provide professional support to SC/ST entrepreneurs
- The Budget exhibits the intention of the Government to further strengthen and consolidate some of the important on-going initiatives for other vulnerable sections viz. Scheduled Castes (SCs), Scheduled Tribes (STs), minorities, persons with disabilities etc. The Post Matric Scholarship (PMS) Scheme for SC students had BE of only about Rs. 1600 crore in 2015-16 which was enhanced to Rs. 2216 crore at RE stage. The scheme needed some mid-course correction for better implementation, which is under process. Provision of an amount of Rs. 2791 crore has been made for the scheme for 2016-17 i.e. increase by 74 % over BE of previous year. Similarly the plan allocation for the Department of Social Justice and Empowerment has been increased from Rs. 5912 crore in 2015-16 (RE) to Rs. 6500 crore in 2016-17 (BE).
- With respect to persons with disability, the areas which draw attention in the Budget of 2016-17 are: Assistance to Disable Persons for purchase/ fitting of Aids and Appliances and Accessible India Campaign (Sugamya Bharat Abhiyan) and Implementation of Persons with Disability Act, 1995. The Sugamya Bharat Abhiyan was launched by the Prime Minister of India on 5th December, 2015. The activities related to the campaign are mainly for rehabilitation and provision of barrier free access. The range of activities include ramps, lifts, tactile paths, accessible toilets, new product development, creation of accessible websites and research, etc. The Department of Empowerment of Persons with Disabilities will have a Plan allocation of Rs. 700 crore during 2016-17 (BE) against Rs. 540 crore in 2015-16(RE).
- The major initiatives for STs include Special Central Assistance to Tribal Sub-Plan Area; Grant-in-Aid under Article 275(1); provision for education of the children under the Umbrella Scheme for Development of Scheduled Tribes; and Vanbandu Kalyan Yojana. The allocation for Special Central Assistance for Tribal Sub-Plan area has been increased from

Rs. 1132 crore in 2015-16 (RE) to Rs. 1250 crore in 2016-17 (BE). The Umbrella Scheme for Development of Scheduled Tribes, which is mainly for education of the children, will have Rs. 1505 crore in 2016-17 (BE) against RE of Rs. 1211 crore in the previous year. The Vanbandu Kalyan Yojana will have a substantially enhanced allocation of Rs. 505 crore in 2016-17 (BE) compared to BE of Rs. 200 crore in the previous year. The total allocation for Ministry of Tribal Affairs has been increased from Rs. 4550 crore in 2015-16 (RE) to Rs. 4800 crore in 2016-17 (BE).

- The enhanced allocation of Rs. 3800 crore provided to the Ministry of Minority Affairs for 2016-17 (BE) over Rs. 3713 crore in 2015-16 (RE) will, inter alia, cater to the requirement of payment of scholarships for the promotion of education amongst children belonging to minority communities. The allocation includes Rs. 1125 crore for the Multi-sectoral Development Programme (MsDP), which is a flagship programme to address the Infrastructural gaps and to provide basic amenities to the minorities. Total allocation of the Ministry will have provision of Rs. 385 crore, for 'Nai Manzil', a new scheme announced by the Finance Minister in budget speech of 2015-16. The scheme is aimed at mobilising youths from minority communities, who are school dropouts and provide them formal education and integrated skill training in market driven skills for their self/wage employment.
- In addition to the above, the Scheduled Castes Sub-Plan (SCSP) and Tribal Sub-Plan (TSP) are major on-going initiatives for inclusive growth of the SCs and STs. The SCSP component of the Union Budget has been enhanced from Rs. 34,675 crore in 2015-16 (RE) to Rs. 38,833 crore in 2016-17 (BE). Similarly, Provision from Tribal Sub-Plan (TSP) has been increased from Rs. 20,963 crore in 2015-16 (RE) to Rs. 24,005 crore in 2016-17 (BE).

(Source: <http://niti.gov.in/content/union-budget-2016-17-big-boost-inclusive-growth-vulnerable-groups>)

## INDIAN AGRICULTURE INDUSTRY

Agriculture plays a vital role in India's economy. Over 58 per cent of the rural households depend on agriculture as their principal means of livelihood. Agriculture, along with fisheries and forestry, is one of the largest contributors to the Gross Domestic Product (GDP).

As per estimates by the Central Statistics Office (CSO), the share of agriculture and allied sectors (including agriculture, livestock, forestry and fishery) was 15.35 per cent of the Gross Value Added (GVA) during 2015-16 at 2011-12 prices.

India is the largest producer, consumer and exporter of spices and spice products. India's fruit production has grown faster than vegetables, making it the second largest fruit producer in the world. India's horticulture output, comprising fruits, vegetables and spices, is estimated to be 283.4 million tonnes (MT) in 2015-16 after the third advanced estimate. It ranks third in farm and agriculture outputs. Agricultural export constitutes 10 per cent of the country's exports and is the fourth-largest exported principal commodity. The agro industry in India is divided into several sub segments such as canned, dairy, processed, frozen food to fisheries, meat, poultry, and food grains.

The Department of Agriculture and Cooperation under the Ministry of Agriculture is responsible for the development of the agriculture sector in India. It manages several other bodies, such as the National Dairy Development Board (NDDB), to develop other allied agricultural sectors.

### Market Size

Over the recent past, multiple factors have worked together to facilitate growth in the agriculture sector in India. These include growth in household income and consumption, expansion in the food processing sector and increase in agricultural exports. Rising private participation in Indian agriculture, growing organic farming and use of information technology are some of the key trends in the agriculture industry.

As per the 3rd Advance Estimates, India's foodgrain production has increased marginally to 252.23 million tonnes (MT) in the 2015-16 crop year. Production of pulses is estimated at 17.06 million tonnes.

With an annual output of 146.31 MT, India is the largest producer of milk, accounting for 18.5 per cent of the total world production. It also has the largest bovine population. India, the second-largest producer of sugar, accounts for 14 per cent of the global output. It is the sixth-largest exporter of sugar, accounting for 2.76 per cent of the global exports. India is a leading country in coconut production and productivity in the world, with annual production of 2,044 crore coconuts and the productivity of 10,345 coconuts per hectare as on 2015-16. Spice exports from India are expected to reach US\$ 3 billion by 2016-17 due to creative marketing strategies, innovative packaging, strength in quality and strong distribution networks. The spices market in India is valued at Rs 40,000 crore (US\$ 5.87 billion) annually, of which the branded segment accounts for 15 per cent. In fact, the Spices

Board of India has decided to set up a spice museum at Willingdon Island in Kochi to attract and educate tourists and seafarers about the history and growth of Indian spices industry.

Indian agrochemical industry is expected to grow at 7.5 per cent annually to reach US\$ 6.3 billion by 2020 with domestic demand growing at 6.5 per cent per annum and export demand at 9 per cent per annum\*.

### **Investments**

Several players have invested in the agricultural sector in India, mainly driven by the government's initiatives and schemes.

According to the Department of Industrial Policy and Promotion (DIPP), the Indian agricultural services and agricultural machinery sectors have cumulatively attracted Foreign Direct Investment (FDI) equity inflow of about US\$ 2,278.3 million from April 2000 to March 2016.

Some major investments and developments in agriculture in the recent past are as follows:

- Intertek Group, a UK-based total quality assurance provider, has launched an agricultural technology (Agritech) Laboratory in Hyderabad, which will perform high-tech deoxyribonucleic acid (DNA) analyses for the agri-biotech, plant seeds.
- ITC Ltd, one of India's leading fast-moving consumer goods (FMCG) company, plans to make Andhra Pradesh a hub for its agricultural business operations.
- Mahindra and Mahindra Ltd has acquired 35 per cent stake in a Finnish combine harvesters manufacturer, Sampo Roselnew Oy, for US\$ 20.46 million and will jointly focus on the combine harvester business in Asia, Africa and Eurasian Economic Union countries.
- The Small Farmers' Agri-Business Consortium (SFAC) plans to organise camps in Madhya Pradesh and Chhattisgarh to promote its venture capital assistance scheme (VCAS), which seeks to provide capital and project development facility (PDF) to agri-business entrepreneurs.
- Agri-research institute ICRISAT's incubation arm is looking to set up a Rs.100 crore (US\$ 14.67 million) fund in a year, an initiative that could help small entrepreneurs from the agri-business and nutrition space raise money.
- Mahindra & Mahindra (M&M), India's leading tractor and utility vehicle manufacturer, announced its entry into pulses retailing under the brand 'NuPro'. Going forward, the company plans to foray into e-retailing and sale of dairy products.
- Fertiliser cooperative IFFCO launched a joint venture with Japanese firm Mitsubishi Corp for manufacturing agrochemicals in India.
- Acumen, a not-for-profit global venture fund, has invested Rs 11 crore (US\$ 1.7 million) in Sahayog Dairy, an integrated entity in the segment, based at Harda district in Madhya Pradesh.
- Rabo Equity Advisors, the private equity arm of Netherlands-based Rabo Group, raised US\$ 100 million for the first close of its second fund – India Agri Business Fund II. The fund plans to invest US\$ 15–17 million in 10–12 companies.
- Oman India Joint Investment Fund (OIJIF), a joint venture (JV) between the State Bank of India (SBI) and State General Reserve Fund (SGRF), invested Rs 95 crore (US\$ 13.94 million) in GSP Crop Science, a Gujarat-based agrochemicals company.

### **Government Initiatives**

Given the importance of the agriculture sector, the Government of India, in its Budget 2016–17, planned several steps for the sustainable development of agriculture. The Government of India has started work on 99 major and medium irrigation projects, slated to be completed by 2019. These projects will bring 7.6 million hectares of land under irrigation in some of the most drought-prone regions of India.

Some of the recent major government initiatives in the sector are as follows:

- The government has drawn up a five-year roadmap to increase pulse production from nearly 17.06 MT in 2015-16 to 24 MT in 2020-21 through a dedicated action plan.
- Prime Minister Mr Narendra Modi has unveiled the operational guidelines for the Pradhan Mantri Fasal Bima Yojana which aims to provide farmers with crop insurance as well as



- The Cabinet Committee on Economic Affairs (CCEA) has approved 'Blue Revolution', an umbrella scheme for integrated development and management of fisheries by Government of India, with total financial outlay of Rs 3,000 crore (US\$ 440.15 million) for a period of five years.
- Mr Piyush Goyal, Minister of Power, Coal, New and Renewable Energy has announced that government's plans to invest Rs 75,000 crore (US\$ 11.08 billion) in an energy-efficient irrigation scheme over the next three to four years.
- The new crop insurance scheme for farmers 'Bhartiya Krishi Bima Yojana' aims to cover 50 per cent of the farmers under the scheme in the next two-three years,
- India and Lithuania have agreed to intensify agricultural cooperation, especially in sectors like food and dairy processing.
- Gujarat Government has planned to connect 26 Agricultural Produce Market Committees (APMCs) via electronic market platform, under the National Agriculture Market (NAM) initiative.
- The State Government of Telangana plans to spend Rs 81,000 crore (US\$ 11.88 billion) over the next three years to complete ongoing irrigation projects and also undertake two new projects for lifting water from the Godavari and Krishna river.
- The National Dairy Development Board (NDDB) announced 42 dairy projects with a financial outlay of Rs 221 crore (US\$ 32.42 million) to boost milk output and increase per animal production of milk.
- Government of India has set up an inter-ministerial committee, which will look into ways to examine the potential of Indian agriculture, identify segments with potential for growth, and work towards doubling farm incomes by 2022.
- The Government of India has allocated Rs 200 crore (US\$ 29.9 million) for electronically linking 585 major wholesale agriculture markets across the country, thereby creating a National Agriculture Market (NAM) in July 2015 for three years

(Source: <http://indianbusiness.nic.in/newdesign/index.php?param=advantage/165>)

## WORLD AGRICULTURE

Agricultural development is one of the most powerful tools to end extreme poverty, boost shared prosperity and feed 9 billion people by 2050. Growth in the agriculture sector is about two to four times more effective in raising incomes among the poorest compared to other sectors. This is important for 78 percent of the world's poor who live in rural areas and depend largely on farming to make a living.

But agriculture-driven growth and poverty reduction, as well as food security are at risk: A warming climate could cut crop yields by more than 25 percent. Agriculture and land use change are also responsible for between 19–29 percent of global greenhouse gas emissions. Mitigation in the agriculture sector is part of the solution to climate change.

(Source: <http://www.worldbank.org/en/topic/agriculture/overview>)

*Enabling the Business of Agriculture (EBA)* promotes smart regulations that ensure safety and quality control while at the same time promote efficient regulatory processes that support agribusinesses. Regulation in agriculture is justified to address market failures and protect safety, health and the environment. But some governments do not tackle these issues through appropriate regulation. Regulations may introduce burdensome procedures that shift economic activity to greater informality and corruption without even attaining the original objectives. So it is important to assess the efficiency and quality of specific regulations. The EBA methodology highlights smart regulation in each of the measured areas. This methodology has been informed by an extensive literature review and consultations with experts.

For chemical fertilizers, for example, controls are necessary to prevent damage to the soil and adulterated fertilizer use but excessive tests that prolong fertilizer registration for years and cost thousands of dollars are difficult to defend. Similarly burdensome import procedures, which require fertilizer importers to make purchases months in advance, can hinder market access. EBA assigns higher scores to countries with laws requiring the labeling of fertilizer and prohibiting the sale of open or mislabeled fertilizer bags. At the same time, countries that allow the private sector (including foreigners) to import fertilizers or do not require re-registration if the product has been already registered in another country are also seen as following good practices and given high scores.

**FIGURE 1.1 Regional performance on EBA indicators**

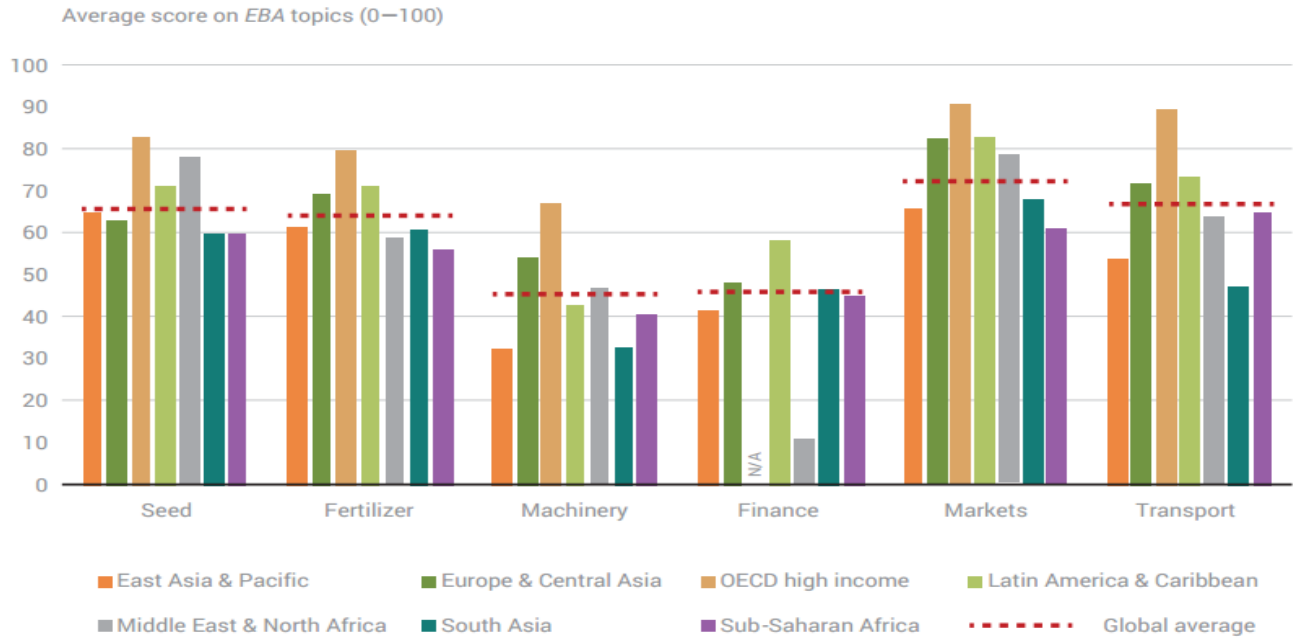

(Source: [http://eba.worldbank.org/~/\\_/media/WBG/AgriBusiness/Documents/Reports/2016/EBA16-Full-Report.pdf](http://eba.worldbank.org/~/_/media/WBG/AgriBusiness/Documents/Reports/2016/EBA16-Full-Report.pdf))

**FERTILIZER INDUSTRY**

**Fertilizer Demand:** Following a drop in 2015/16, world fertilizer demand is anticipated to recover in 2016/17

In response to the economic slowdown in many emerging and developing countries, persistent low international prices for most agricultural commodities, and dry conditions across South Asia, Southeast Asia, Latin America and Africa, world fertilizer demand is expected to contract by 1.0% in 2015/16, to 181 million tonnes (Mt) nutrients. Aggregate demand in 2015/16 is anticipated to rebound in the three regions where it contracted in 2014/15: Eastern Europe & Central Asia (EECA), West Asia and North America. Demand is seen as dropping elsewhere

The outlook for 2016/17 is more optimistic in view of slightly improving market conditions, the expected more favorable weather, and a better political and economic situation in some sizable markets. Global fertilizer demand in 2016/17 is seen as rebounding (+2.9%) to 186 Mt, with growth rates of relatively similar magnitude for all three nutrients.

Demand in developed countries is anticipated to rise marginally, with stronger prospects in Oceania. With N and P demand in China levelling off, about half the world market can be considered ‘mature’. In volume terms, South Asia, East Asia and Latin America would account for 33%, 22% and 22%, respectively, of the global increase in total fertilizer demand anticipated in the next five years.

**Fertilizer Supply:** 2015 was characterized by near-stagnant fertilizer demand. Production capacity and supply availability have both been increasing. Entering 2016, the fertilizer industry continues to face overcapacity conditions and market pressures caused by bearish fertilizer demand and intensified supply competition. Rationalization and consolidation activities have begun in key producing countries. Several producers recently embarked on cost reduction and operational efficiency programmes.

Large integrated producing groups are proceeding to a re-segmentation of activities in order to further engage in the high added-value specialty fertilizer segment.

Between 2016 and 2020 the fertilizer industry will invest close to US\$130 billion in more than 150 new production units, increasing global capacity by over 150 million tonnes products.

### Phosphate Outlook

Global phosphate rock supply would grow 11% compared with 2015, to reach 250 Mt of phosphate concentrate in 2020. Together Africa, Saudi Arabia and China would account for three fifths of this 25 Mt increase.

Global phosphoric acid capacity in 2020 is projected to expand by 13% over 2015, to 65.3 Mt P<sub>2</sub>O<sub>5</sub> in 2020. Large capacity additions would occur in Morocco, China and Saudi Arabia. The global supply of phosphoric acid would increase by 2.4% p.a. compared with 2015, while demand would grow at 2.5%, pointing to a stable potential surplus between 2015 and 2017 followed by a moderate increase towards 2020. Global capacity for the main processed phosphate fertilizers would grow by 7 Mt P<sub>2</sub>O<sub>5</sub> between 2015 and 2020, to 52 Mt P<sub>2</sub>O<sub>5</sub>. Three exporting countries (Morocco, Saudi Arabia and China) would account for the bulk of the increase.

### Sulphur Outlook

Global sulphur production is projected to grow by 4% p.a. compared with 2015, reaching 72 Mt S in 2020. The largest increases in production will occur in the sulphur exporting regions of West Asia and EECA during the next five years, each at 6% p.a. Global consumption of elemental sulphur is projected to grow at an annual rate of 3% compared with 2015, reaching 69 Mt S in 2020. The global supply/demand situation will shift from a near equilibrium condition in 2015 to the emergence of growing surplus towards 2020.

(Source - <http://www.fertilizer.org/> - Fertilizer Outlook 2016-2020)

### Fertilizer Industry in India

In meeting the domestic requirement of food grains and also generating exportable surpluses, the significant role played by chemical fertilizers is well organized.

As of now, the country has achieved 80% self-sufficiency in production capacity of Urea. As a result, India could manage its substantial requirement of nitrogenous fertilizers through the indigenous industry besides imports. Similarly, 50% indigenous capacity has developed in respect of phosphatic fertilizers to meet domestic requirements. However, the raw-materials and intermediates for the same are largely imported. For potash (K), since there are no viable sources/ reserves in the country, its entire requirement is met through imports.

The actual production of all the Fertilizers during the year 2014-15 was 370.03 LMT. The estimated production of all the fertilizers during the year 2015-16 is 402.93 LMT showing an increase of more than 8.89% in comparison of the previous year. The installed capacity has reached a level of 207.53 LMT in respect of Complex Fertilizers during the year 2015-16. The rapid build-up of fertilizer production in the country has been achieved as a result of a favourable policy environment facilitating large investments in the public, co-operative and private sectors.

### Sector - wise, Installed capacity of Urea, DAP and Complex fertilizers during 2015-16:

S. No.	Sector	Annual Installed Capacity		
		Urea <sup>8</sup> *	DAP	Complex Fertilizers
1	Public Sector	63.09	-	21.64
2	Cooperative Sector	54.19	27	16.35
3	Private Sector	90.25	56.32	22.73
	<b>Total</b>	<b>207.53</b>	<b>83.32</b>	<b>60.72</b>

(Source: [http://fert.nic.in/sites/default/files/Annual\\_Report\\_2015-2016\\_English.pdf](http://fert.nic.in/sites/default/files/Annual_Report_2015-2016_English.pdf))

### Fertilizer Policy

For sustained agricultural growth and to promote balanced nutrient application, it is imperative that fertilizers are made available to farmers at affordable prices. With this objective, urea being the only controlled fertilizer, is sold at statutory notified uniform sale price, and decontrolled Phosphatic and Potassic fertilizers are sold at indicative maximum retail prices (MRPs). The problems faced by the manufacturers in earning a reasonable return on their investment with reference to controlled prices, are mitigated by providing support under the New Pricing Scheme for Urea units and the concession Scheme for decontrolled Phosphatic and

Potassic fertilizers. The statutorily notified sale price and indicative MRP is generally less than the cost of production of the irrespective manufacturing unit. The difference between the cost of production and the selling price/MRP is paid as subsidy/concession to manufacturers. As the consumer prices of both indigenous and imported fertilizers are fixed uniformly, financial support is also given on imported urea and decontrolled Phosphatic and Potassic fertilizers.

#### **Fertilizer Subsidy Policy for Phosphatic & Potassic (P&K) and SSP Fertilizers:**

The basic purpose/objective of the Concession Scheme for P&K fertilizers has been to provide P&K fertilizers to the farmers at affordable prices so as to increase the food productivity in the country through balanced use of fertilizers. The concession scheme was also aimed at ensuring reasonable rate of return on the investments made by the entrepreneurs in the fertilizer sector. Initially, the ad-hoc Concession Scheme was applicable on DAP, MOP, NPK Complex fertilizers. This scheme was also extended to SSP from 1993-94.

- (a) **P&K Fertilizers except SSP:** 85% (90% with Bank Guarantee) of the subsidy claims of fertilizer companies is paid as 'on account' payment on receipt of fertilizers in the district on certification by the Company's Statutory Auditor. The balance 15-10% is released on State government's certification of quantity in m-FMS and fertilizer receipt confirmation by retail dealers through mobile Fertilizer Monitoring System (m-FMS).
- (b) **SSP:** 85% (90% with Bank Guarantee) of the claim of subsidy is paid as 'on account' payment on 1st point sale of fertilizers in the districts on certification by the Company's Statutory Auditor. The balance 10-15% claim is released subject to State Government's certification on quantity and quality in m-FMS as well as fertilizer receipt confirmation by retail dealers through m-FMS.

(Source: <http://fert.nic.in/page/fertilizer-policy>)

## OUR BUSINESS

*Some of the information contained in the following discussion, including information with respect to our plans and strategies, contain forward-looking statements that involve risks and uncertainties. You should read the section “Forward-Looking Statements” for a discussion of the risks and uncertainties related to those statements and also the section “Risk Factors” for a discussion of certain factors that may affect our business, financial condition or results of operations. Our actual results may differ materially from those expressed in or implied by these forward looking statements. Our fiscal year ends on March 31 of each year, so all references to a particular fiscal are to the Twelve-month period ended March 31 of that year. In this section, a reference to the “Company” or “we”, “us” or “our” means Krishana Phoschem Limited.*

*All financial information included herein is based on our “Financial information of the Company” included on page 157 of this Prospectus.*

### OVERVIEW

Incorporated in 2004, we are primarily engaged in manufacturing of fertilizers, intermediate dyes and other allied chemical products in the state of Madhya Pradesh. We are manufacturers of Benefited Rock Phosphate (BRP), Single Super Phosphate (SSP), Granulated Single Super Phosphate (GSSP), H-Acid, intermediate dyes and other allied chemicals. Our products Single Super Phosphate (SSP) and Granulated Single Super Phosphate (GSSP) is used in replenishing “P” (Phosphorous) in the soil and act as a fertilizer for crop. Initially our company was engaged in manufacturing of BRP and further expanded to forward integration in manufacturing of SSP and GSSP and expanding for Diversification in intermediate dyes and other allied chemicals.

Our Company manufacture specialized chemicals used for dyeing cloth such as H acid, E K acid, Vinyl sulphone, PNCBOSA, 4 sulphoantranilic acid, Violet acid, Sulpho Tobias acid. The chemicals produce by our company is used as Dye intermediate specifically for textiles Industry.

Our manufacturing facilities are located near the Jhabua, Meghnagar District (M.P), and distributed in two units, viz:

- Unit - I located at 115-120 & 126-133, A.K.V.N. Industrial Area, Meghnagar, Jhabua, Madhya Pradesh installed with production capacity of 200000 MT of Beneficiated Rock Phosphate (BRP), 120000 MT of Single Super Phosphate (SSP) and 90000 MT of Granulated Single Super Phosphate (GSSP).
- Unit - II located at 142 & 143, AKVN Industrial Area, Meghnagar, Jhabua, Madhya Pradesh with installed capacity of acids and other chemicals such as E K Acid, H Acid, H-ACID (By Production from E K Acid), PNCBOSA, Sulpho Anthranilic Acid, Sulpho tobias Acid (STA), Vinyl Sulphone and Violet Acid.

In Addition to above, our company is in process for installation of Unit - III located at 126 A & 134, AKVN Industrial Area, Meghnagar, Jhabua, Madhya Pradesh for manufacturing of sulphuric acid, Chloro sulphonic Acid, Liquid SO<sub>3</sub> and other allied chemicals. Sulphuric acid is a highly corrosive strong mineral acidulfuric acid has a wide range of applications including in domestic acidic drain cleaners, as an electrolyte in lead-acid batteries and in various cleaning agents. It is also a central substance in the chemical industry.

We are an ISO 9001:2008 certified company for manufacturing & supply of Benefited Rock Phosphate (BRP), Single Super Phosphate (SSP) and Granulated Single Super Phosphate (GSSP). Our manufacturing facilities are well equipped with required facilities including machinery, Feed Hopper, Conveyor Belt, Crusher and other handling equipments to facilitate smooth manufacturing process.

Our Company was initially promoted by Mr. Roop Lal Patel, Mrs. Leela Patel, Mr. Jitendra Patel, Mr. Vinod Paliwal, Mrs. Geeta Paliwal, Mr. Narendra Paliwal and Mr. Dilip Kumar Gadia with an object for manufacturing of fertilizers and has successfully implemented the SSP plant at Unit I in the year 2004. The commercial production was started in year 2005-06. Later in the year 2007 the company was taken-over by Mr. Praveen Ostwal and Seasons Agro Chem India Pvt. Ltd. Presently Mr. Praveen Ostwal, Ostwal Phoschem (India) Limited and Seasons Agro Chem India Pvt. Ltd. are Promoters of the Company.

We have entered into the marketing arrangement by signing an Supply and Purchase agreement dated March 20, 2015 for our product SSP with DCM Shriram Limited (through its unit M/s Shriram Fertilizers & Chemicals) for a period of five years, for supply of SSP minimum 40000 Mt per annum. Additionally Rock phosphate and Sulphuric acid are captively consumed to manufacture SSP fertilizer. The other main ingredient of raw material for SSP i.e. Sulphuric Acid is procured from Hindustan Zinc Limited (HZL) and

B Roshan Lal & Chemicals Pvt. Limited etc. We have an excellent business relationship with HZL from a long period of time. Additionally to make fully integrated manufacturing facility, we are in process of setting Unit – III for manufacturing of Sulphuric acid to fulfill the requirement of raw material for manufacturing of SSP and thereby to enter into backward integration. We have quality control checks before any consignment of Raw material is accepted since it has a direct impact on the quality of Finished Product.

Our Company has established a quality control laboratory for analyzing samples of ore received from the mine, regular samples from the process of various streams, reagents and effluents. Rock phosphate samples are analyzed by volumetric/gravimetric methods and use of Instruments like P-H meter, Spectroscope, Electronic weigh Balance, Oven, Muffle furnace etc., and slurry sample preparation requires vacuum filtration and drying. Samples are preserved for some period as reference samples.

For the period ended November 30, 2016 our Company's Total Revenue and Restated Profit after Tax were Rs. 4519.64 Lacs and Rs. 392.39 Lacs, respectively. For the year ended March 31, 2016, our Company's Total Revenue and Restated Profit after Tax were Rs. 9062.67 Lacs and Rs. 315.30 Lacs, respectively. For the year ended March 31, 2015, our Company's Total Revenue and Restated Profit after Tax was Rs. 7725.82 Lacs and Rs. 292.79 Lakhs respectively, compared to our Company's Total Income and Restated Profit after Tax of Rs. 9083.70 Lacs and Rs. 504.54 Lacs respectively, over previous year ended i.e. March 31, 2014.

### **Certifications & Recognitions:**

The high quality and consistency of our products has won the confidence of our customer. Some of the prominent certifications and recognitions received by our Company are the following:-

- ❖ **ISO 9001:2008** certification for manufacturing & Supply of Beneficiated Rock Phosphate (BRP), Single Super Phosphate (SSP) and Granulated Single Super Phosphate (GSSP). The certificate is in recognition of the Company's Quality Management System and is valid till January 17, 2017
- ❖ Our Company has consecutively got Commendation certificate for best Taxpayer from Madhya Pradesh Commercial Department for all the financial years from 2007-08 to 2011-12.

### **OUR BUSINESS STRENGTH:-**

#### **1. Cost Effective sourcing and Strategic Location of Manufacturing Unit:-**

We believe that our cost efficient manufacturing and supply chain management results in a significant reduction in our operational costs. With our experience, we are able to gauge our procurement of raw materials in timely manner. Further, our manufacturing units, situated within the state of Madhya Pradesh are ensured with sufficient raw material which is locally procured. The location of our current manufacturing facilities gives us a significant competitive cost advantage in terms of raw material sourcing manufacturing and labour costs and enables us to address the western markets efficiently.

#### **2. Quality assurance**

Our Company has a testing division and an in house laboratory which is responsible for the final approval of product manufactured. The final product manufactured has to undergo a quality check before it is finally packed and dispatch. We also have quality control checks before any consignment of Raw material is accepted since it has a direct impact on the quality of Finished Product. Our Quality assurance has enabled us provide satisfactory performance to our Customer.

#### **3. Leveraging the expertise of our Promoters and Management Team:-**

Our Promoters are engaged in Mineral beneficiation plant and Fertilizer Industries, which also form part of Board of Directors of our Company. Also, our Company is managed by a team of professional & experienced personnel. The team comprises of personnel having operational and business development experience. We believe that our management team's experience and their understanding of the industry will enable us to continue to take advantage of both current and future market opportunities. It is also expected to help us in addressing and mitigating various risks inherent in our business, including significant competition and the global economic crisis.

#### **4. Forward integration and Diversification:-**

Initially our company was engaged in manufacturing of Beneficiated Rock Phosphate (BRP) in Unit – I with installed capacity of 2,00,000 MT. As a step towards forward integration our Company has set up a manufacturing facilities for production of Single Super Phosphate (SSP) with an installed processing capacity of 1,20,000 MT in the year 2012-13 and production of Granulated Single Super Phosphate (GSSP) with an installed processing capacity of 90,000 MT in the year 2013-14 at Unit –I situated at 115-120 A.K.V.N Industrial area, Meghnagar, Jhabua (M.P.), Madhya Pradesh. Furthermore we have diversified our business into manufacturing of intermediate dyes and other allied chemicals in our Unit II situated at Meghnagar, Jhabua, Madhya Pradesh.

#### **5. Existing relationship with suppliers:-**

We buy low grade rock from Madhya Pradesh State Mines and Minerals Limited and sulphuric acid from Hindustan Zinc Limited and B Roshan Lal & Chemicals Private Limited etc. We had also entered into a Memorandum of Understanding dated September 02, 2004 with Madhya Pradesh State Mining Corporation for purchase of low-grade rock for a period of 10 years. Based on our relationship with supplier, we are still procuring our raw material i.e. Rock Phosphate from MPSMC. Also we have acquired other raw materials from several suppliers and have maintained relationship with them for a long time. Due to our relationships with our suppliers, we get quality and timely supplies of raw materials. This enables us to manage our inventories and supply quality products.

### **OUR BUSINESS STRATEGIES:-**

#### **1. Optimal Utilization of Resources:-**

Our Company constantly endeavors to improve our manufacturing process, and will increase service activities to optimize the utilization of resources. We have invested significant resources, and intend to further invest in our activities to develop customized systems and processes to ensure effective management control. We regularly analyze our existing policies to be carried out for our manufacturing process which enables us to identify the areas of bottlenecks and correct the same. This helps us in improving efficiency and putting resources to optimal use.

#### **2. Continue to invest significantly in R&D**

We intend to increase our initiatives in R & D in order to constantly study industry verticals to identify product inefficiencies in areas in which we could add value. Going forward, we intend to expand our research and development capabilities, by increasing our investment in employing qualified individuals from the industry thereby augmenting our dedicated in-house R&D team. We believe that continued investments in R&D will enable us to increase our productivity, improve our operating efficiency, and enable us to penetrate existing and new market segments.

#### **3. To build-up a professional organization:-**

As an organization, we believe in transparency and commitment in our work and with our customers. We have an experienced team for taking care of our day to day operations. We also consult with external agencies on a case to case basis on technical and financial aspects of our business. We will consistently put efforts among its group of experienced employees to transform them into an outstanding team of empowered professionals which helps in further accelerating the wheels of development of the Organization.

#### **4. Develop and maintain relationships with our Suppliers and Customers:-**

We believe in maintaining good relationship with our Suppliers and Customers which is the most important factor to keep our Company growing. Our dedicated and focused approach and efficient and timely delivery of products has helped us build strong relationships over a number of years. We bag and place repetitive order with our customers as well as with our suppliers. For us, establishing strong, mutually beneficial long-term relationships with strategic supplier relationship management is a critical step in improving performance across the supply chain, generating greater cost efficiency and enabling the business to grow and develop.

#### **5. Broaden and Deepen Our Geographical Presence**

We intend to deepen market penetration and increase our market share for existing products, as well as to position ourselves to successfully commercialize our products under development and any additional products for which we may receive approval. We

may either form important relationships with companies with strong local presence through whom we can undertake our own sales and marketing.

**SWOT ANALYSIS:**

**Strengths**

- Well Established Manufacturing facility
- Quality assurance and Standard
- Experienced Management Team.
- Long term Trade
- Proximity to Raw Material (Low Grade Rock Phosphate & Sulphur) & Long Term Agreements
- Supportive Central and State Government Policies.

**Weakness**

- Working Capital Intensive Business
- Low bargaining power with customers

**Opportunities**

- High Growth Potential
- Government Initiatives for fertilizer Industry

**Threats**

- Industry is prone to change in government policies
- Government intervention

**Our Manufacturing facilities:-**

**Unit I**



**Unit II**





**Our Products:-**

S.No.	Products	Description
1.	<b>Beneficiated Rock Phosphate (BRP)</b>	Beneficiated Rock Phosphate (BRP) is Industrial product in nature as the same is used as raw material by Manufacturing Units producing SSP (Single Super phosphate). The basic raw material used is Rock Phosphate since beneficiation is a process done on Rock Phosphate to remove its impurities. Beneficiation is a process by which valuable constituents of an ore are concentrated by means of a physical separation.
2.	<b>Single Super Phosphate (SSP)</b>	Single Superphosphate is produced by reacting naturally occurring phosphate rock with sulphuric acid. This process converts insoluble phosphates into forms more readily available to plants. Single Super Phosphate (SSP) is used by farmers to improve the productivity levels of their soil which get eroded each year. SSP is used in large quantities for replenishing "P" (Phosphorus) in the soil which gets depleted steadily with each crop. This is preferred phosphate fertilizer by the farmers as it provides much needed nutrients "S" along with "P" unlike other fertilizer.
3.	<b>Granulated Single Super Phosphate (GSSP)</b>	Single Super phosphate (SSP) in form of granulated form is called Granulated Single Super Phosphate. The use of granulated product is more beneficial than the use of powder. The granulated product rolls down the plant and can be used harmlessly on the standing crops. The biggest advantage in using the granulated product is that it is available to the crops for a longer time because it gets dissolved slowly in water.
4.	<b>Intermediate Dyes and other chemicals</b>	Acid includes Di-Calsiam Phosphate (DCP), E K Acid, H Acid, H-ACID (By Production from E K Acid), PNCBOSA, Solpho Anthranilic Acid, Sulpho tobias Acid (STA), Vinyl Sulphone and Violet Acid.

**Features of our Products**

- ❖ Highest Demanded Fertilizer, because of its Low price per kg it is preferred by small and marginal farmers and can be blended with other fertiliser products (except Urea & DAP)
- ❖ Readily accepted by the crops as SSP comprises of 14.50% water soluble phosphate and the ratio of phosphorus and sulphur suits many crop and pasture needs.
- ❖ Only Phosphatic fertilizer which can utilize Indian rock phosphate deposits
- ❖ Can be stored easily for long periods, without taking up moisture.

**OUR LOCATION:-**

<b>Registered Office &amp; Head Office</b>	5-O-20 Basement R.C Vyas Colony, Bhilwara- 311001, Rajasthan
<b>Factory</b>	<b>Unit I</b> –115-120 & 126 -133 AKVN Industrial area, Meghnagar, Jhabua, Madhya Pradesh.
	<b>Unit II</b> – 142 & 143, AKVN Industrial Area, Meghnagar, Jhabua, Madhya Pradesh
	<b>Unit III</b> – 126 A &134, AKVN Industrial Area, Meghnagar, Jhabua, Madhya Pradesh
<b>Godown</b>	Khasra No. 667 and 668, Village Ojayada, Hamirgarh, Dist. Bhilwara, Rajasthan

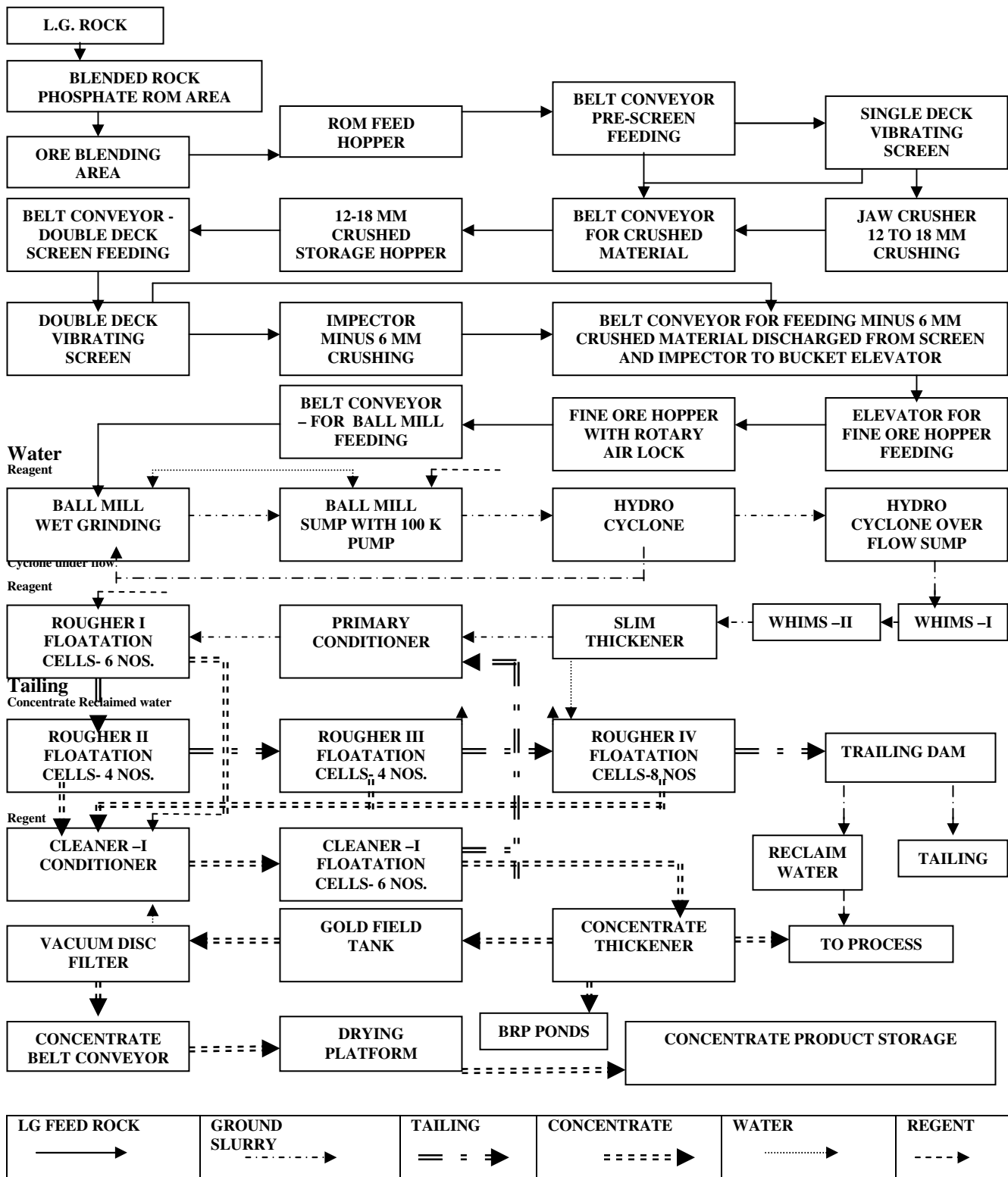
**MANUFACTURING PROCESS FLOW CHARTS:-**
**➤ Beneficiated Rock Phosphate**

## Steps Involved:-

The process for rock phosphate ore beneficiation entails following unit operations:-

- a) Crushing and Screening
- b) Wet Grinding and Classification
- c) Froth Flotation
- d) Solid-Liquid Separation
- e) Tailing disposal and water reclamation.
- f) Regent Preparation and distribution
- g) Quality Control
- h) Support Facilities

### Crushing and Screening

ROM Ore (200 mm) is received in the plant through trucks/dumpers and is weighed in the company's weigh bridge before getting unloaded in ore stock pile. The crushed ore is dumped into ore hopper with the help of JCB.

Ore from the hopper is fed to a belt conveyor by the help of ore feeder/apron feeder. The ore is crushed in a Jaw Crusher. The ore is fed to a D.D.Vibrating screen. Oversize material of +50 mm size is fed to Roll Crusher/Hammer crusher and the under size (-10 mm) gravitates on the belt conveyor. The Belt conveyor takes the material to the 300 tons capacity Fine ore bin. A Tramp iron magnet installed on the conveyor removes any iron material.

All the transfer points of the conveyor belts and vibrating screen/Roll crusher shall be provided with dust extraction ducting. Whereas, ore stock yard shall have an adequate water spray arrangement to suppress dust.

### Wet Grinding and Classification

Ore is fed to belt conveyor with the help of ore feeders/table feeders. The belt conveyor feeds the material into grate discharge Ball Mill (size-2400 mm dia x 3600 mm length) driven by 300 KW 3.3 KV Motor. Electronic Belt Weigh Scale mounted on the belt conveyor records the ore feed rate and totalize the quantity on shift/daily/monthly basis.

Water is added in the feed chute and Mill Discharge sump to regulate the pulp density for the efficient grinding and classification ahead. Feed belt conveyor is driven by variable A.C frequency drive motor.

Wet ground slurry is pumped to Hydro cyclones (1Op+1Sb)) with the help of special slurry pumps (100 K Wilfley) (1Op+1Sb). Ore is normally ground to < 75 microns.

Over flow from the Hydro cyclones is fed to the Magnetic Separator for the removal iron oxide. Non-Magnetics are taken to thickener and non-magnetics gravitate to MS Tank.

Non magnetic slurry thickened to 35-40% solids is fed to 2400mm dia x 2400mm ht HDO MSRL conditioner. The conditioned pulp is floated in series of 100 cft Denver Flotation Cells. The phosphate concentrate produced from Denver Flot, cells is called as 'Rougher' concentrate (RHC). RHC is cleaned in 60 cft Galigher Flot., cells (called Cleaner and Re-cleaner cells) twice to yield final phosphate product having + 32% P<sub>2</sub>O<sub>5</sub>. Tailings from Cleaner cells and Re-cleaner cells are re circulated in reverse order. Tailing (P<sub>2</sub>O<sub>5</sub>-<6%) from Rougher cells constitute final Tails which are pumped to Settling ponds.

Adequate number of slurry pumps, Concentrate pumps and Air Blowers/Fans are installed for transferring slurry/pulp from one stage to other for efficient processing. All operating pumps have stand by pumps to ensure trouble free operation

### Solid-Liquid Separation

Final Phosphate concentrate and Tailings are pumped to respective 12m dia x 3 m SWH Thickeners for the concentration of solids. Over flow water from both the thickeners and other settling tanks are pumped to 'Reclaimed water' storage tanks for the use in the process. Fresh make-up water from the company's bore wells and other sources/AKVN are stored in the Ground storage tank and Over Head storage tanks.

Phosphate concentrate thickened to +50% solids is pumped to Over Head Storage agitated tank. Phosphate concentrate is fed to Belt Press Filter for filtering the concentrate. Filtrate from the filter is recycled.

The product is conveyed to storage shed through belt conveyor. Belt weigh scale is installed on the belt to record weight of the product.

### **Tailing disposal and water reclamation**

Water is reclaimed from the thickeners and tailing dam which is re-used in the process plant. The reclaimed water quality is monitored for suspended solids and P-H. Alum is used as flocculent to facilitate fast settling of solids.

### **Reagent Preparation and distribution**

Flotation process requires some flotation reagents/chemicals which help to selectively float the phosphate and depress waste/gangue minerals like silica, iron, aluminium oxide and carbonates. The reagents are:- a) Sodium oleate, b) sodium silicate c) Starch.

All these reagents are added in dilute solution form (5 to 10% solution) at different pre-selected locations with the help of reagent feeders.

Plant has adequate facility to store reagents, prepare solutions and distribution system.

### **Quality Control**

Quality control laboratory is set up for analyzing samples of ore received from the mine, regular samples from the process of various streams, reagents and effluents. Rock phosphate samples are analyzed by volumetric/gravimetric methods and use of Instruments like P-H meter, Spectroscope, Electronic weigh Balance, Oven, Muffle furnace etc.,

Slurry sample preparation requires vacuum filtration and drying. Samples are preserved for some period as Reference samples.

### **Support Facilities**

Plant would be equipped with support facilities to ensure smooth operation with minimum down time. The support facilities may be summarized as under:-

- a) Front End Loader
- b) J.C.B
- c) D.G.Set- 125 KVA
- d) EOT Cranes/Grab crane
- e) Lathe Machine
- f) Shaper/Drill Machine (Verticle)
- g) Plate Bending Machine
- h) Special tools & Tackles
- i) Electric Chain Pulley Blocks of 1,2 & 5 Tons
- j) Computer/Soft ware/PBX/PAX etc



6. **Den** - Den is a slow rotating machine where reaction completed upto 90% and noxious gases go to scrubber section where gases are scrubbed in presence of water and finally pollution free gases go to the atmosphere with the help of ID fan and chimney.
7. **Den Cutter** - In this process, slurry gets hard and cut in powder form. This powder is known as Single Super Phosphate (SSP)
8. **Finished Shed** – The Single Super Phosphate is stored at finished shed for 5-6 days in piles to the reaction of Sulphuric Acid.
9. **Packing & Dispatch** – In this Stage the final product of Single Super Phosphate is ready for packaging into Bag and dispatched to our Customers.

➤ **Granular Single Super Phosphate**

**G.S.S.P. PROCESS FLOW CHART**

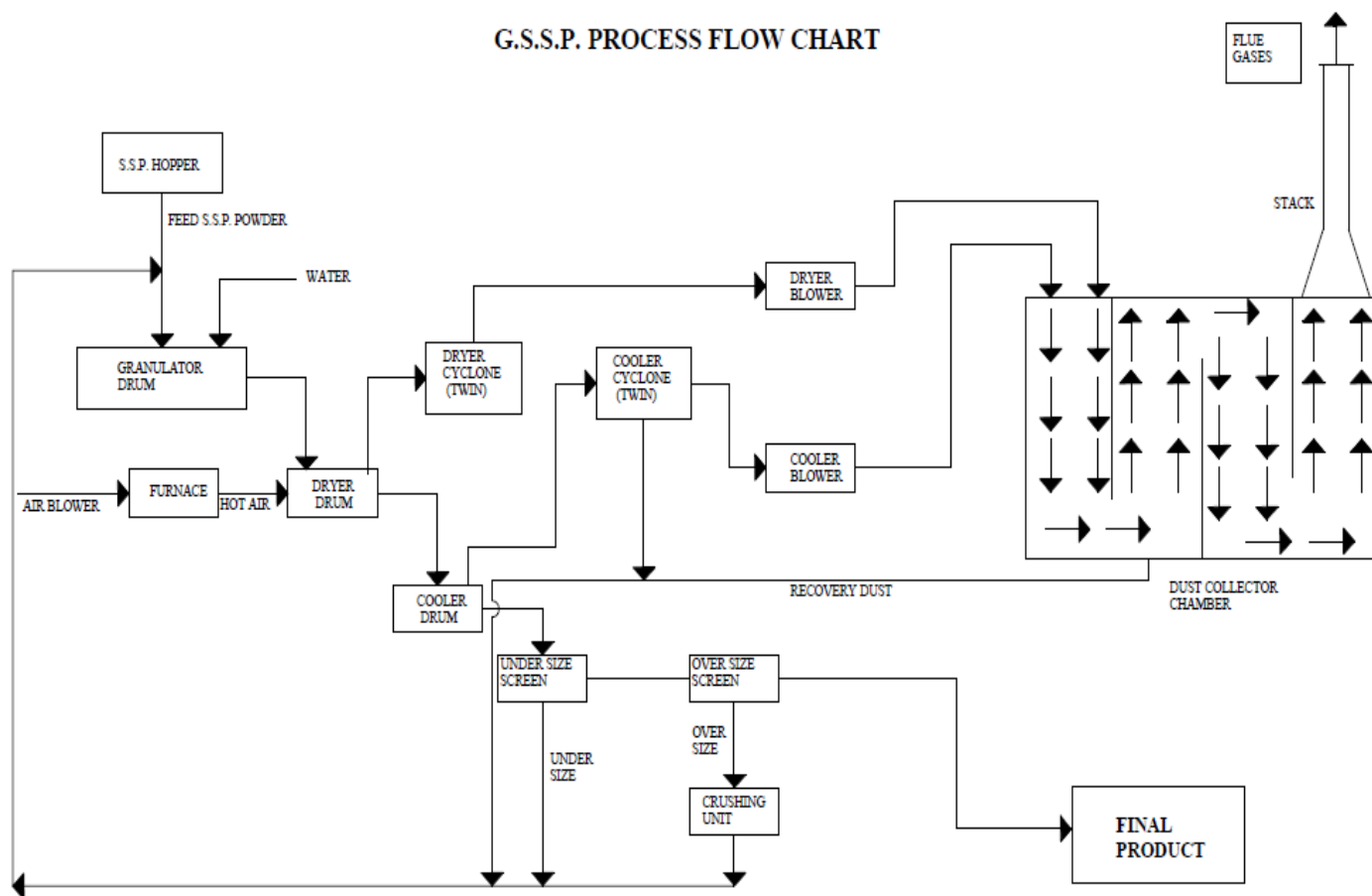

**Manufacturing Process of Granular Single Super Phosphate**

SSP powder is fed into Granulator drum where powder SSP gets converted into granular with addition of water droplets. These granules are fed to granules get dried by blowing hot air. Hot air is generated by burning coal in hot air granulator. Later on dried granules are fed to cooler drum where hot granules get cooled and conveyed to screens where 1 to 4 mm granules collected for packing and more than 4 mm are crushed and recycled all together with less than 1 mm size material. The outlet of drier drum and inlet of cooler drum remain connected with a series of cyclones and I D fans & finally with a chimney to remove dust particles and make air free from dust before releasing to atmosphere.

**CAPACITY UTILISATION:-**

Particulars	Existing			Proposed			
	2013-14	2014-15	2015-16	Nov, 2016	March, 2017	2017-18	2018-19
<b>Unit - I</b>							
<b>Beneficiated Rock Phosphate (BRP)</b>							
Total Installed Capacity (Metric tonnes)	200000	200000	200000	200000	200000	200000	200000
Capacity Utilization (in %)	31.70%	5.43%	4.02%	3.64%	10.20%	10.20%	10.20%
<b>Super Single Phosphate (SSP)</b>							
Total Installed Capacity (Metric tonnes)	120000	120000	120000	120000	120000	120000	120000
Capacity Utilization (in %)	85.23%	71.74%	68.21%	55.43%	83.33%	83.33%	83.33%
<b>Granulated Single Super Phosphate (GSSP)</b>							
Total Installed Capacity (Metric tonnes)	90000	90000	90000	90000	90000	90000	90000
Capacity Utilization (in %)	10.62%	24.04%	24.63%	19.84%	30.45%	30.45%	30.45%
<b>Unit II</b>							
<b>Intermediate Dyes and H-Acid</b>							
Total Installed Capacity (Metric tonnes)	-	-	-	1324	1324	1324	1324
Capacity Utilization (in %)	-	-	-	2.57%	21.15%	43.23%	57.24%
<b>Unit III</b>							
<b>Sulphuric Acid</b>							
Total Installed Capacity (Metric tonnes)	-	-	-	-	49500	49500	49500
Capacity Utilization (in %)	-	-	-	-	-	60.00%	90.00%

**PLANT & MACHINERY:-**

We have installed sufficient Plant and Machinery in all the manufacturing units for manufacturing of Single Super Phosphate, Beneficiated Rock Phosphate, Granulated Single Super Phosphate (GSSP), H-Acid and Sulphuric Acid. Brief details of major Plant and Machinery installed for each Product are as follows:-

**Single Super Phosphate (SSP):-** Coarse Rock Hopper, C.R. Belt Conveyor, C.R. Mill Feed Hopper, Grinding Mill, Model SM-8 Mill Fan, Mill Feeder Rotary valve, Fine Rock Cyclone, Dust collector Bag filter assembly, Ground Rock discharge rotary valve, Ground Rock Hopper (6 M X 3M X 4 M), Rotary valve, Screw Conveyor, Elevator, Surge Hopper, Screw Conveyor, Weigh Belt Feeder Electronic, Mixer, Den, Cutter, RP Den, Scrubber Pump, Lagoon Pump, Water Pump, Acid pump, Scrubber ID Fan, Acid Storage Tank, Tanker Unloading Tank, Chimney MSRL, EOT Crane, LT Motor, Crabing Motor, Hoisting Motor, CT Motor.

**Beneficiated Rock Phosphate (BRP):-** Rock Phosphate Feed Hopper, Belt Conveyor for Screen feeding before crushing, Vibrating Grizzly Screen, Jaw Crusher, Bucket Elevator, Fine Ore Storage Hopper, Wet Grinding Ball Mill, Primary Hydro Cyclone, Cleaner – Flotation Cells, Rougher Flotation Cells, Concentrate Pump for Cleaner, Silicate Storage Tank, Reagent Transfer pump, Gold Field Tank, Slime Thickener, Water Cooling Plant, Blower SLM Maniklal Rotary Positive Displacement, Dust Collection system, Drill Machine, Lathe Machine, Saping Machine, Hydrolych Interlock Bricks Machine, Roll Crusher and Jaw Crusher.

**Granulated Single Super Phosphate (GSSP):-** Raw Material Hopper, feed belt, Elevator, Granulation Drum, Dryer Drum, DC Belt, Cooler Drum Dia, Cooler outlet belt, Under Size screen, Over size Screen, Chain Mill, Dryer Blower, Coller Blower, Recycle Belt, Production Belt, Production Hopper, Sticking machine with packing Conveyor, Sticker/ Loader, Twin Cyclone for Dryer and for Cooler, Chimney, Hot air Genrator, Priamary Air Blower, Slicer at R.M elevator inlet

**H-Acid:-** Sulphuric Acid Storage Tank, Oleum Storage Tank, Nitric Acid Storage Tank, Measuring Tank for Sulphuric acid, Measuring Tank for Oleum, Measuring Tank for Nitric, CI Sulphonator 8 KL with gear motor, CI Sulphonator 10 KL with gear motor (old), Nitrator with gear motor, Neturiliser with gear motor, Lime slurry vessel with gear motor, Lime slurry vessel with gear motor, Belt Filter system Vaccum receiver, Vaccum pump with motor, Vaccum pump water circulation tank, Belt wash water tank,

Nitro solution holding tank, Nitro solution holding tank, Nitro solution back wash tank, Reduction vessel with gear motor stirrer, Reduction mass filter box, PP Filter press, Dilute amino solution holding tank, Dilute amino solution holding tank, Concentrate amino holding tank, Amino solution back wash tank, M.S. Auto Clave, M.S. Reboiler, Fusion mass holding tank, stirrer, H acid isolation vessel, H acid filter neutch, Centrifuge, Vaccum receiver, Vaccum trap, Vaccum pump, H acid filter, ML Neturiliser, Nox scrubbing column, Syntex tank, Hot water tank, SO<sub>2</sub> scrubbing ventury, SBS scrubbing tank, SBS scrubbing tank, Methanol measuring tank, Methanol recovery column, Heat Exchanger, Spent acid storge tank, Air compressure, Boiler, Thermic fluid boiler, Boiler water storage tank, Spin Flash Dryer, Blender, Wet cake crusher machine, Cooling tower, Chilling plant, Chilling water storage tank, D G Set 500 KVA, Cooling water storage tank, Filter Press

**COLLABORATIONS/TIE UPS/ JOINT VENTURES:-**

Except as disclosed in this Prospectus and normal course of business, we do not have any Collaboration/Tie Ups/ Joint Ventures as on date.

**EXPORT OBLIGATION:**

Our Company does not have any export obligation as on date

**SALES AND MARKETING:-**

Marketing is an important function of our organization. Our success lies in the strength of our relationship with our customer who has been associated with our Group for a long period. Also our Company has entered to a Memorandum of understanding with DCM Shriram Limited (its Unit M/s Shriram Fertilizers & Chemicals) (“Our Customer”) to source and market the Single Super Phosphates (SSP) for the period of five years from April 01, 2015 and Beneficiated Rock Phosphate (BRP) are captivity consumed by the SSP plant and if any surplus will be sold out in the market and considering the same no marketing arrangements are required for BRP.

**Marketing Strategy:**

We intend to focus on following marketing strategies:

1. Focus on existing markets.
2. To expand our existing distribution base
2. Continuously holding markets Trends.
3. Supply of Quality Products.
4. Fulfillment of Order Quantity.

**COMPETITION:-**

SSP is one of the fertilizers which are in bulk demand in India and there are few dedicated players in this line of activity. There are certain few peer companies whose one of the products manufactured is SSP; they are manufacturing other complex fertilizers along with manufacturing SSP. We face substantial competition for our products from other manufacturers in domestic market. Our competition varies for our products and regions. Some of our major competitors are:-

- Rama Phosphates Limited
- 
- Aries Agro Limited
- Coromandel International Limited

**INFRASTRUCTURE & UTILITIES:-****Raw Materials:-**

The raw material required by us is usually sourced either domestically or from international markets. Our Company has also been adopting a strategy of forward integration whereby BRP, being the basic raw material for manufacturing SSP is produced in our Unit I for captive consumption. Over the years, such strategy has not only helped us to increase the proportion of raw material



sourced internally from our own production but also reduced our dependency on suppliers. Although we have an established supplier base with whom we have been dealing for years.

For Manufacturing BRP, the main raw material required is “Rock Phosphate” and along with it Sodium Silicate, Sodium Oleate etc. is mixed so as to convert this low grade rock phosphate into high grade rock phosphate and this low grade rock phosphate is abundantly available from Mines which are under control of Madhya Pradesh State Mining Corporation (MPSMC). We had also entered into a Memorandum of Understanding dated September 02, 2004 with Madhya Pradesh State Mining Corporation for purchase of low-grade rock for a period of 10 years. Based on our relationship with supplier, we are still procuring our raw material i.e. Rock Phosphate from MPSMC.

For Manufacturing of SSP, the main raw material is Beneficiated Rock Phosphate (BRP), Sulphuric Acid and water. Our company is also entered into agreement with Deepak Nitrate Limited dated April 01, 2016 for supply of Dilute Sulphuric Acid. Also we had an established supplier base with which we have been dealing for years. We have quality control checks before any consignment of Raw material is accepted since it has a direct impact on the quality

For Manufacturing of GSSP, the main raw material is Single Super Phosphate (BRP) and water to make the powder form into Granulated form.

For Manufacturing of H-Acid, the main raw material is Naphthalene, Sulphuric Acid, Oleum, Nitric Acid, Sodium Sulphate, Lime Powder, C.I powder, Caustic soda flakes, Spent acid, Solvent, Soda Ash.

**Power:-**

The requirement of power for our operations, like power for lighting and operating the machinery/equipment is met through MPPKVV (M.P. Paschim Kshetra Vidyut Vitran Nigam Co. Ltd.) for all the Units.

**Water:-**

Our water requirement is for production process and for general purpose also. Water requirement is fulfilled through open well at factory site and through boring.

**Logistics:**

The plant of the company is well connected with road and situated at just 20 Kms away from the National highway Indore- Jhabua. The Meghnagar railway station also is only 3 Kms far away from the plant location. The railway station also has a rack point to facilitate the loading and unloading of containers. So there is no problem about the transportation. Its very well connected with 3 state Maharashtra, Gujarat and Rajasthan.

**Human Resource:-**

We have experienced Promoter and management whom we rely on to anticipate industry trends and capitalize on new business opportunities that may emerge. We believe that our employees are key contributors to our business success. We focus on attracting and retaining the best possible talent. Our Company looks for specific skill-sets, interests and background that would be an asset for its kind of business. Our senior management team consists of experienced individuals with diverse skills in manufacturing, engineering, and finance. Our manpower is a prudent mix of the experienced and youth which gives us the dual advantage of stability and growth.

As on 30 November 2016, we have 64 employees (including HO Staff and Factory Workmen) on payroll and our Company hires contract labour in our factories as per requirement of the work. The details of which is given below:

Sr. No.	Particular	Employees
1.	Head Office Staff	18
2.	Unit – I	41
3.	Unit – II	3
4.	Unit – III	2
<b>Total</b>		<b>64</b>

**INSURANCE:-**

We maintain a range of insurance policies to cover our assets, risks and liabilities. Substantially all of our insurance policies related to our registered office, factories, our movable property provide appropriate coverage in relation to fire, explosions, floods, inundations, earthquakes, landslides, marine cargo and workmen compensation claims by our personnel. We constantly evaluate the risks in an effort to be sufficiently covered for all known risks. We believe that the amount of insurance coverage presently maintained by us represents an appropriate level of coverage required to insure our business and operations and is in accordance with the industry standard in India.

**PROPERTY:-****Intellectual Property:-**

Our Company does not own any trademark on its own name except as disclosed below:-

S.No.	Logo/Trademark	Class	Nature of Trademark	Owner	Application No. & Date	Remarks
1.	Trademark	Class - 1		Krishana Limited Phoschem	Application No.:- 2376371 Date of Application - 08/08/2012	Opposed

In Addition to above, our company has signed an Agreement for use of Logo dated November 24, 2016 with our Group Company “Ostwal Phoschem (India) Limited (formerly known as Tedco Granite Limited)” for use of trademark. Below are the details of trademark used by our Company:-

S.No.	Logo/Trademark	Class	Nature of Trademark	Owner	Application No. & Date	Remarks
1.	Trademark	Class - 1		Ostwal Phoschem (India) Limited (Formally known as Tedco Granite Limited)	Application No.:- 1927451 Date of Application - 25/02/2010	Valid Upto 25/02/2020

The Details of Domain Name registered on the name of the Company is:-

S.No.	Domain Name and ID	Sponsoring Registrar and IANA ID	Creation Date	Registration Expiry Date
1.	<a href="http://www.krishnaphoschem.com">www.krishnaphoschem.com</a> Registry Domain ID: 1432944007_DOMAIN_COM-VRSN	Registrar: PDR Ltd. d/b/a PublicDomainRegistry.com Registrar IANA ID: 303	March 25, 2008	March 25, 2018

**IMMOVABLE PROPERTY:-**

Details of our properties are as follows: -

S. No.	Details of the Property	Actual Use	Owned/ Leased/ License	Licensor / Lessor / Vendor	Consideration/ Lease Rental/ License Fees
<b>REGISTERED OFFICE</b>					
1.	5-O-20, Basement R C Vyas Colony, Bhilwara – 311001, Rajasthan, India.	Registered Office	Leased	Ostwal (India) [Lessor]	Phoschem Limited Lease Agreement dated May 1, 2015 for a period of 15 years between Ostwal Phoschem (India) Limited and Krishana Phoschem Limited for Annual rent of Rs. 5,000/-.
<b>UNIT I</b>					
1.	Plot No. 115, 116, 117 and 118-A, Meghnagar Jhabua, Madhya Pradesh	Unit I	Leased	Madhya Pradesh Vikas Nigam (Indore) [Lessor]	Pradesh Kendra Nigam Limited Lease Agreement dated August 27, 2004 for a period of 30 years commencing from 25/08/2004 to 24/08/2034 between Madhya Pradesh Audyogik Kendra Vikas Nigam (Indore) Limited and Krishana Phoschem Limited for Annual ground rent of Rs. 25,473/-, Annual Development Fund for maintenance of Industrial Area of Rs. 25,473/- and Annual Street Light charges of Rs. 5,095/-.
2.	Plot No. 118-B, 119 and 120, Meghnagar Jhabua, Madhya Pradesh		Leased	Madhya Pradesh Vikas Nigam (Indore) [Lessor]	Pradesh Kendra Nigam Limited Lease Agreement dated July 07, 2008 for a period of 30 years commencing from 07/07/2008 to 06/07/2038 between Madhya Pradesh Audyogik Kendra Vikas Nigam (Indore) Limited and Krishana Phoschem Limited for Annual ground rent of Rs. 18,529/- and Annual Maintenance charges of Rs. 56,148/-.
3.	Plot No. 126 – 133, Meghnagar Jhabua, Madhya Pradesh		Leased	Madhya Pradesh Vikas Nigam (Indore) [Lessor]	Pradesh Kendra Nigam Limited Lease Agreement dated January 03, 2009 for a period of 30 years commencing from 03.01.2009 to 02.01.2039 between Madhya Pradesh Audyogik Kendra Vikas Nigam (Indore) Limited and Krishana Phoschem Limited-for Annual ground rent of Rs. 51,995/- and Annual Maintenance charges of Rs. 76,811/-.
<b>UNIT II</b>					
1.	Plot No. 142 and 143, Meghnagar Jhabua, Madhya Pradesh	Unit II	Leased	Madhya Pradesh Vikas Nigam (Indore) [Lessor]	Pradesh Kendra Nigam Limited Lease Agreement dated July 23, 2010 for a period of 30 years commencing from July 23, 2010 to July 22, 2040 between Madhya Pradesh Audyogik Kendra Vikas Nigam (Indore) Limited and Krishana Phoschem Limited for Annual ground rent of Rs. 39,600/- and Annual Maintenance charges of Rs. 60,000/-.
<b>UNIT III</b>					
1.	Plot No. 126-A and 134, Meghnagar Jhabua, Madhya Pradesh	Unit III	Leased	Madhya Pradesh Vikas Nigam (Indore) [Lessor]	Pradesh Kendra Nigam Limited Lease Agreement dated March 15, 2012 for a period of 30 years commencing from March 15, 2012 to March 14, 2042 between Madhya Pradesh Audyogik Kendra Vikas Nigam (Indore) Limited

and Krishana Phoschem Limited for Annual ground rent of Rs. 38,500/- and Annual Maintenance charges of Rs. 55,000/-.

**GODOWN**

1.	Khasra No. 667 and 668, Village Ojayada, Hamirgarh, Dist. Bhilwara, Rajasthan	Godown	Leased	Seasons Agro Chem India Pvt. Ltd. [Lessor]	Lease Agreement dated December 23, 2015 for a period of 3 years between Seasons Agro Chem India Pvt. Ltd. and Krishana Phoschem Limited for Annual rent of Rs. 2,000/-.
----	---	--------	--------	--	---

## **REGULATIONS AND POLICIES**

*The following description is a summary of the relevant regulations and policies as prescribed by the Government of India, and the respective bye laws framed by the local bodies, and others incorporated under the laws of India. The information detailed in this Chapter has been obtained from the various legislations, including rules and regulations promulgated by the regulatory bodies and the bye laws of the respective local authorities that are available in the public domain. The regulations and policies set out below may not be exhaustive and are only intended to provide general information to the investors and are neither designed nor intended to be a substitute for professional advice. The Company is primarily engaged in the business of manufacturing fertilizers and allied chemical products.*

*The statements below are based on the current provisions of Indian law, and the judicial and administrative interpretations thereof, which are subject to change or modification by subsequent legislative, regulatory, administrative or judicial decisions. The regulations set out below may not be exhaustive, and are only intended to provide general information to Applicants and is neither designed nor intended to be a substitute for professional legal advice.*

*For details of Government and Other Approvals obtained by the Company in compliance with these regulations, see section titled "Government and Other Approvals" beginning on page 222 of the Prospectus.*

### **A. BUSINESS/TRADE RELATED LAWS/REGULATIONS**

#### **Essential Commodities Act, 1955**

The Essential Commodities Act, 1955 gives powers to control production, supply, and distribution etc. of essential commodities, for maintaining or increasing supplies and for securing their equitable distribution and availability to the Central Government. Various Ministers / Departments of the Central Government and Government/UT Administrations have issued Control Orders for regulating production / distribution / quality aspects / movement etc. pertaining to the commodities which are essential and administered by them under the Act.

The state government/UT Administrators have issued various control orders to regulate various aspects trading in Essential Commodities such as food grains, edible oils, pulses, sugar etc. The Central Government regularly monitors the action taken by the State Government /UT Administrators to implement the provisions of the Essential Commodities Act, 1955.

#### **Fertilizer Subsidy Policy for Phosphatic & Potassic (P&K) Fertilizers:**

Since independence, Government of India has been regulating sale, price and quality of fertilizers. For this purpose, Government of India has passed Fertilizer Control Order (FCO) under Essential commodity Act (EC Act) in the year 1957. No subsidy was paid on Fertilizers till 1977 except Potash for which subsidy was paid only for a year in 1977. On the recommendation of the Maratha Committee, the Government had introduced Retention Price Scheme (RPS) for nitrogenous fertilizers in November 1977. Subsequently, RPS was extended to phosphatic and other complex fertilizers from February 1979 and to Single Super Phosphate from May 1982, which continued up to 1991. Later on, subsidy was also extended to imported phosphatic and potassic (P&K) fertilizers. Fearing imbalance fertilization of the soil, unaffordability by farmers due to increase in phosphatic and potassic fertilizer prices, Government of India announced ad hoc Concession Scheme for phosphatic and potassic fertilizers from Rabi 1992 to cushion the impact of price hike with a view to encourage balanced fertilizer consumption. Initially, the ad-hoc Concession Scheme was applicable on DAP, MOP, NPK Complex fertilizers. This scheme was also extended to SSP from 1993-94. The basic purpose/objective of the Concession Scheme for P&K fertilizers has been to provide P&K fertilizers to the farmers at affordable prices so as to increase the food productivity in the country through balanced use of fertilizers. The concession scheme was also aimed at ensuring reasonable rate of return on the investments made by the entrepreneurs in the fertilizer sector.

#### **Fertilizers Control Order, 1985**

**Govt. of India to promote the fertilizer industries in India & to control the quality & prices of fertilizer has issued such order.** The major clauses of the said order applicable to our Company are as below:

### **1. Fixation of prices of fertilizers –**

- a. The Central Government may, with a view to regulating equitable distribution of fertilisers and making fertilisers available at fair prices, by notification in the Official Gazette, fix the maximum prices or rates at which any fertilizer may be sold by a dealer, manufacturer, importer or a pool handling agency.
- b. The Central Government may having regard to the local conditions of any area, the period of storage of fertilisers and other relevant circumstances, fix different prices or rates for fertilisers having different periods of storage or for different areas or for different classes of consumers.
- c. No dealer, manufacturer, importer or pool handling agency shall sell or offer for sale any fertiliser at a price exceeding the maximum price or rate fixed under this clause. Our products are not falling under price controls.

### **2. Allocation of fertilizers to various States**

The Central Government may, with a view to securing equitable distribution and availability of fertilisers to the farmers in time, by notification in the Official Gazette, direct any manufacturer/importer to sell the fertilisers produced by him in such quantities and in such State or States and within such period as may be specified in the said notification.

### **3. Application for intimation or registration**

- a. Every person intending to sell or offer for sale or carrying on the business of selling of fertilizer as Industrial Dealer shall obtain a certificate of registration from the controller by making an application in Form A together with the fee prescribed under clause 36 and a Certificate of source in Form O.
- b. Every person including a manufacturer, an importer, a pool handling agency, wholesaler and a retail dealer intending to sell or offer for sale or carrying on the business of selling of fertilizer shall make a Memorandum of Intimation to the Notified Authority, in Form A1 duly filled in, in duplicate, together with the fee prescribed under clause 36 and certificate of source in Form O.
- c. On receipt of a Memorandum of Intimation, complete in all respects, the Notified Authority shall issue an acknowledgement of receipt in Form A2 and it shall be deemed to be an authorization letter granted and the concerned person as authorised dealer for the purposes of this Order.

### **4. Period of validity of certificate of registration and letter of authorization**

Every certificate of registration granted under clause 9 and every authorization letter issued under clause 8 shall, unless renewed, suspended or cancelled, be valid for a period of three years from the date of its issue.

### **5. Renewal of certificates of registration and authorization letters**

If an application for renewal of a certificate of registration or authorization letter is not made within one month from the date of expiry of their period of validity, the same shall be deemed to have lapsed on the 119 date on which its validity expired and any business carried on after that date shall be deemed to have been carried on in contravention of clause 7.”

### **Manufacture of Mixtures and Fertilizers**

#### **6. Restriction on preparation of mixtures of fertilizer**

No person shall carry on the business of preparing any mixture of fertilizers or special mixture of fertilizers except under and in accordance with the terms and conditions of a certificate of manufacture granted to him under clauses 15 or 16.

#### **7. Standards of mixtures of Fertilizers**

- a. Subject to the other provisions of the order, no person shall manufacture any mixture of fertilisers whether of solid or liquid fertilisers unless such mixture conforms to the standards set out in the notification to be issued by the Central Government in the Official Gazette;
- b. Subject to the other provisions of this order, no person shall manufacture any “mixture of fertilisers unless such mixture conforms to the standards set out in the notification to be issued by the State Government in the Official Gazette;

Explanation- For the purposes of this sub-clause, mixture of fertilizers shall not include liquid fertilizers and 100% water soluble fertilizers, containing N. P. K.

- c. No Certificate of manufacture shall be granted in respect of any fertiliser which does not conform to the standards set out in the notification referred in sub- clause (1) or (2);
- d. Nothing in this clause shall apply to special mixtures of fertilisers.

### **8. Application for certificate of manufacture of mixtures of fertilisers**

Every person desiring to obtain a certificate of manufacture for preparation of any mixture of fertilisers or special mixture of fertilisers shall possess such mixture, and possess the minimum laboratory facility as specified in clause 21A of this Order.

### **9. Period of validity of a certificate of manufacture for preparation of mixtures of fertilisers**

Every certificate of manufacture granted under clause 15 for preparation of a mixture of fertilisers shall, unless suspended or cancelled, be valid for a period of three years from the date of issue.

## **B. CORPORATE AND COMMERCIAL LAWS**

### **The Companies Act, 1956**

The Act deals with laws relating to companies and certain other associations. It was enacted by the parliament in 1956. The Companies Act primarily regulates the financing, functioning and winding up of companies. The Act prescribes regulatory mechanism regarding all relevant aspects including organizational and financial aspects of companies. In the functioning of the corporate sector, although freedom of companies is important, protection of the investors and shareholders, on whose funds they flourish, is equally important. The Companies Act plays the balancing role between these two competing factors, namely, management autonomy and investor protection.

### **The Companies Act, 2013**

The Companies Act, 2013, has been introduced to replace the existing Companies Act, 1956 in a phased manner. The Ministry of Corporate Affairs has vide its notification dated September 12, 2013 has notified 98 Sections of the Companies Act, 2013 and the same are applicable from the date of the aforesaid notification. A further 183 Sections 110 have been notified on March 26, 2014 and have become applicable from April 1, 2014. The Companies (Amendment) Act, 2015 has inter-alia amended various Sections of the Companies Act, 2013 to take effect from May 29, 2015. Further, vide the Companies (Amendment) Act, 2015, Section 11 of the Companies Act, 2013 has been omitted and Section 76A has been inserted in the Companies Act, 2013. The Ministry of Corporate Affairs, has also issued rules complementary to the Companies Act, 2013 establishing the procedure to be followed by companies in order to comply with the substantive provisions of the Companies Act, 2013.

### **The Competition Act, 2002**

The Competition Act, 2002 “prohibits anti competitive agreements, abuse of dominant positions by enterprises and regulates “combinations” in India. The Competition Act also established the Competition Commission of India (the “CCI”) as the authority mandated to implement the Competition Act. The provisions of the Competition Act relating to combinations were notified recently on March 4, 2011 and came into effect on June 1, 2011. Combinations which are Likely to cause an appreciable adverse effect on competition in a relevant market in India are void under the Competition Act. A combination is defined under Section 5 of the Competition Act as an acquisition, merger or amalgamation of enterprise(s) that meets certain asset or turnover thresholds. There are also different thresholds for those categorized as „Individuals and „Group. The CCI may enquire into all combinations, even if taking place outside India, or between parties outside India, if such combination is Likely to have an appreciable adverse effect on competition in India. Effective June 1, 2011, all combinations have to be notified to the CCI within 30 days of the execution of any agreement or other document for any acquisition of assets, shares, voting rights or control of an enterprise under Section 5(a) and (b) of the Competition Act (including any binding document conveying an agreement or decision to acquire control, shares, voting rights or assets of an enterprise); or the board of directors of a company (or an equivalent authority in case of other entities) approving a proposal for a merger or amalgamation under Section 5(c) of the Competition Act. The obligation to notify a combination to the CCI falls upon the acquirer in case of an acquisition, and on all parties to the combination jointly in case of a merger or amalgamation.

### **Indian Contract Act, 1872**

Indian Contract Act codifies the way we enter into a contract, execute a contract, implement provisions of a contract and effects of breach of a contract. The Act consists of limiting factors subject to which contract may be entered into, executed and breach enforced as amended from time to time. It determines the circumstances in which promise made by the parties to a contract shall be legally binding on them. Each contract creates some right and duties upon the contracting parties. Indian contract deals with the enforcement of these rights and duties upon the parties. The Indian Contract Act also lays down provisions of indemnity, guarantee, bailment and agency. Provisions relating to sale of goods and partnership which were originally in the act are now subject matter of separate enactments viz., the Sale of Goods Act and the Indian Partnership Act.

### **Standards of Weights and Measures Act, 1976**

This Legislation and the rules made there under apply to any packaged commodity that is sold or distributed. It provides for standardization of packages in specified quantities or numbers, in which the manufacturer, packer or distributor shall sell, distribute or deliver some specified commodity to avoid undue proliferation of weights, measures or number in which such commodities may be packed. The Act regulates interstate trade and commerce in weights and measures and commodities sold, distributed or supplied by weights or measures, pre-packed commodities sold or intended to be sold in the course of inter-state and commerce, inspection of weighing and measuring instruments during their use to prevent fraudulent practices. It also empowers the inspectors appointed under the provision of this Act to search, seize and forfeit non-standard weight or measure and to file case in the court for prosecution. Any person intending to pre-pack or import any commodity for sale, distribution or delivery has to make an application to the Director of Legal Metrology for registration.

### **Legal Metrology Act, 2009**

The Legal Metrology Act replaces the Standards of Weights and Measures Act, 1976 and the Standards of Weights and Measures (Enforcement) Act, 1985. The Legal Metrology Act seeks to establish and enforce standards of weights and measures, regulate trade and commerce in weights, measures and other goods which are sold or distributed by weight, measure or number and for matters connected therewith or incidental thereto. The Legal Metrology Act inter-alia requires any person who manufactures, repairs or sells, or offers, exposes or possesses for repair or sale, any weight or measure, to obtain a license issued by the Controller of Legal Metrology. It has been clarified that no license to repair is required by a manufacturer for repair of his own weight or measure in a State other than the State of manufacture of the same. The Legal Metrology Act inter-alia provides that any person who is required to obtain a license under the Legal Metrology Act or the rules made thereunder, repairs or sells, or offers, exposes or possesses for repair or sale, any weight or measure, without being in possession of a valid license, will be punished in the first instance with fine and for a subsequent offence, with imprisonment and/or fine.

### **The Consumer Protection Act, 1986 (COPRA)**

The Consumer Protection Act, 1986 (COPRA) provides better protection to the interests of consumers. This is enabled with the establishment of consumer councils and other authorities for the settlement of consumers' disputes and matters connected therewith. COPRA protects the consumers against any unfair/restrictive trade practice that has been adopted by any trader or service provider or if the goods purchased by him suffer from any defect or deficiency. In case of consumer disputes, the same can be referred to the redressal forums set up by the government such as the National Commission, the State Commission and the District Forums. Such redressal forums have the authority to grant the following reliefs, that is, removal of defects, replacement of goods, compensation to the consumer, etc. The COPRA provides for a three tier consumer grievance redressal mechanism at the national, state and district levels.

### **Negotiable Instruments Act, 1881**

In India, cheques are governed by the Negotiable Instruments Act, 1881, which is largely a codification of the English Law on the subject. The Act provides effective legal provision to restrain people from issuing cheques without having sufficient funds in their account or any stringent provision to punish them in the event of such cheque not being honoured by their bankers and returned unpaid. Section 138 of the Act, creates statutory offence in the matter of dishonour of cheques on the ground of insufficiency of funds in the account maintained by a person with the banker which is punishable with imprisonment for a term which may extend to two year, or with fine which may extend to twice the amount of the cheque, or with both.



## **C. LAWS AND REGULATIONS REGULATING FOREIGN TRADE AND INVESTMENT**

### **FEMA Regulations**

As laid down by the FEMA Regulations, no prior consents and approvals are required from the Reserve Bank of India, for Foreign Direct Investment under the 'automatic route' within the specified sectoral caps. In respect of all industries not specified as FDI under the automatic route, and in respect of investment in excess of the specified sectoral limits under the automatic route, approval may be required from the FIPB and/or the RBI. The RBI, in exercise of its power under the FEMA, has notified the Foreign Exchange Management (Transfer or Issue of Security by a Person Resident Outside India) Regulations, 2000 ("FEMA Regulations") to prohibit, restrict or regulate, transfer by or issue security to a person resident outside India. Foreign investment in India is governed primarily by the provisions of the FEMA which relates to regulation primarily by the RBI and the rules, regulations and notifications thereunder, and the policy prescribed by the Department of Industrial Policy and Promotion, Ministry of Commerce & Industry, Government of India.

### **Foreign Trade (Development and Regulation) Act, 1992**

This statute seeks to increase foreign trade by regulating the imports and exports to and from India. This legislation read with the Indian Foreign Trade Policy provides that no export or import can be made by a person or company without an importer exporter code number unless such person or company is specifically exempt. An application for an importer exporter code number has to be made to the office of the Joint Director General of Foreign Trade, Ministry of Commerce. An importer-exporter code number allotted to an applicant is valid for all its branches, divisions, units and factories.

## **D. INDUSTRIAL LAWS**

### **Micro, Small and Medium Enterprises Development Act, 2006**

The Micro, Small and Medium Enterprises Development Act, 2006 as amended from time to time ('MSMED Act') seeks to facilitate the development of micro, small and medium enterprises.

The MSMED Act provides for the memorandum of micro, small and medium enterprises to be submitted by the relevant enterprises to the prescribed authority. While it is compulsory for medium enterprises engaged in manufacturing to submit the memorandum, the submission of the memorandum by micro and small enterprises engaged in manufacturing is optional. The MSMED Act defines a supplier to mean a micro or small enterprise that has filed a memorandum with the concerned authorities. The MSMED Act ensures that the buyer of goods makes payment for the goods supplied to him immediately or before the date agreed upon between the buyer and supplier. The MSMED Act provides that the agreed period cannot exceed forty five days from the day of acceptance of goods. The MSMED Act also stipulates that in case the buyer fails to make payment to the supplier within the agreed period, then the buyer will be liable to pay compound interest at three times of the bank rate notified by the Reserve Bank of India from the date immediately following the date agreed upon. The MSMED Act also provides for the establishment of the Micro and Small Enterprises Facilitation Council ('Council'). The Council has jurisdiction to act as an arbitrator or conciliator in a dispute between the supplier located within its jurisdiction and a buyer located anywhere in India.

### **Shops & Commercial Establishments Acts of the respective States in which Our Company has an established place of business/ office ("Shops Act")**

The Shops Act provides for the regulation of conditions of work in shops, commercial establishments, restaurants, theatres and other establishments. The Act is enforced by the Chief Inspector of Shops (CIS) and various inspectors under the supervision and control of Deputy/Assistant Labour Commissioners of the concerned District, who in turn functions under the supervision of Labour Commissioner.

### **Motor Vehicles Act, 1988 and Central Motor Vehicle Rules, 1989**

The purpose of Motor Vehicles Act, 1988 is to regulate the activities associated with the driving licences, vehicle registration, vehicles safety etc. The Central Motor Vehicle Rules, 1989 framed under the above Act also prescribe various road safety measures. The Motor Vehicles Act, 1988 and the Central Motor Vehicle Rules, 1989 (Chapter- II) prescribes stringent procedure for grant of Driving Licences. Changes in the said Act and related rules have a bearing on the business of the Company

### **The Transfer of Property Act, 1882**

The Transfer of Property Act, 1882 establishes the general principles relating to the transfer of property in India. It forms a basis for identifying the categories of property that are capable of being transferred, the persons competent to transfer property, the validity of restrictions and conditions imposed on the transfer and the creation of contingent and vested interest in the property. It also provides for the rights and liabilities of the vendor and purchaser in a transaction for the sale of land.

### **The Specific Relief Act, 1963 (“Specific Relief Act”)**

The Specific Relief Act is complimentary to the provisions of the Contract Act and the Transfer of Property Act, as the Specific Relief Act applies both to movable property and immovable property. The Specific Relief Act applies in cases where the Court can order specific performance of a contract. Specific relief can be granted only for purpose of enforcing individual civil rights and not for the mere purpose of enforcing a civil law. ‘Specific performance’ means Court will order the party to perform his part of agreement, instead of imposing on him any monetary liability to pay damages to other party.

### **Registration Act, 1908**

The Registration Act, 1908 details the formalities for registering an instrument. Section 17 of the Registration Act identifies documents for which registration is compulsory and includes, inter alia, any non-testamentary instrument which purports or operates to create, declare, assign, limit or extinguish, whether in the present or in future, any right, title or interest, whether vested or contingent, in immovable property of the value of `100 or more, and a lease of immovable property for any term exceeding one year or reserving a yearly rent. The Registration Act also stipulates the time for registration, the place for registration and the persons who may present documents for registration. Any document which is required to be compulsorily registered but is not registered will not affect the subject property, nor be received as evidence of any transaction affecting such property (except as evidence of a contract in a suit for specific performance or as evidence of part performance of a contract under the Transfer of Property Act or as evidence of any collateral transaction not required to be effected by registered instrument), unless it has been registered.

### **Indian Stamp Act, 1899**

Stamp duty is payable on all instruments/ documents evidencing a transfer or creation or extinguishment of any right, title or interest in immovable property. The Indian Stamp Act, 1899 provides for the imposition of stamp duty at the specified rates on instruments listed in Schedule I of the Stamp Act. However, under the Constitution of India, the states are also empowered to prescribe or alter the stamp duty payable on such documents executed within the state. Instruments chargeable to duty under the Stamp Act but which have not been duly stamped, are incapable of being admitted in court as evidence of the transaction contained therein. The Stamp Act also provides for impounding of instruments by certain specified authorities and bodies and imposition of penalties, for instruments which are not sufficiently stamped or not stamped at all. Instruments which have not been properly stamped instruments can be validated by paying a penalty of up to 10 times of the total duty payable on such instruments.

### **Madhya Pradesh State Industrial Land and Industrial Building Management Rules, 2015 (erstwhile Madhya Pradesh State Industrial Land and Industrial Building Management Rules, 2008)**

The Madhya Pradesh State Industrial Land and Industrial Building Management Rules, 2015 was enacted by the Madhya Pradesh State Government for the development of underdeveloped Industrial areas and to make provisions for the allotment of land for the purpose of construction of Roads/Sheds, residential, commercial, warehousing and Industrial use. The main objective of these rules is to ensure the maximum use, maintenance and management of Industrial lands, commercial Buildings/sheds etc. that comes under the possession and ownership of Trade, Commerce and Employment departments of the states. All the procedures and the form of documentation for the purpose of allotment of land is provided under the rules and the validity for the allotment of such land for Industrial use is 30 years and for Industrial Building is 10 years.

## **E. ENVIRONMENTAL LAWS**

### **Environment (Protection) Act, 1986**

The Environment (Protection) Act, 1986 was enacted as a general legislation to safeguard the environment from all sources of pollution and prevention of hazards to human beings, other living creatures, plants and property to enable creation of an authority with powers for environmental protection, regulation of discharge of environmental pollutants etc. The purpose of the Act is to act

as an "umbrella" legislation designed to provide a frame work for Central government co-ordination of the activities of various central and state authorities established under previous laws, such as Water Act & Air Act. It includes water, air and land and the inter-relationships which exist among water, air and land, and human beings and other living creatures, plants, micro-organisms and property.

### **The Water (Prevention and Control of Pollution) Act, 1974 ("Water Act")**

The Water Act was enacted in 1974 in order to provide for the prevention and control of water pollution by factories and manufacturing industries and for maintaining or restoring the wholesomeness of water. "Pollution" means such contamination of water or such alteration of the physical, chemical or biological properties of water or such discharge of any sewage or trade effluent or of any other liquid, gaseous or solid substance into water (whether directly or indirectly) as may, or is likely to, create a nuisance or render such water harmful or injurious to public health or safety, or to domestic, commercial, industrial, agricultural or other legitimate uses, or to the life and health of animals or plants or of aquatic organisms. In respect to an Industrial Undertaking it applies to the (i) Occupier (the owner and management of the undertaking) (ii) outlet (iii) Pollution and (iv) Trade effluents. The Act requires that approvals be obtained from the corresponding pollution control Boards in the state

### **The Air (Prevention and Control of Pollution) Act, 1981**

The Air (Prevention and Control of Pollution) Act, 1981 has been enacted to provide for the prevention, control and abatement of air pollution. 'Air Pollution' means the presence in the atmosphere of any 'air pollutant', which means any solid, liquid or gaseous substance (including noise) present in the atmosphere in such concentration as may be or tend to be injurious to human beings or other living creatures or plants or property or environment. The statute was enacted with a view to protect the environment and surroundings from any adverse effects of the pollutants that may emanate from any factory or manufacturing operation or activity. It lays down the Limits with regard to emissions and pollutants that are a direct result of any operation or activity. Periodic checks on the factories are mandated in the form of yearly approvals and consents from the corresponding Pollution Control Boards in the state.

### **Noise Pollution (Regulation & Control) Rules 2000 ("Noise Regulation Rules")**

The Noise Regulation Rules regulate noise levels in industrial, commercial and residential zones. The Noise Regulation Rules also establish zones of silence of not less than 100 meters near schools, courts, hospitals, etc. The rules also assign regulatory authority for these standards to the local district courts. Penalty for non-compliance with the Noise Regulation Rules shall be under the provisions of the Environment (Protection) Act, 1986.

### **Electricity Act, 2003**

The Electricity Act, 2003 has been recently introduced with a view to rationalize electricity tariff, and to bring about transparent policies in the sector. The Act provides for private sector participation in generation, transmission and distribution of electricity, and provides for the corporatization of the state electricity boards. The related Electricity Regulatory Commissions Act, 1998 has been enacted with a view to confer on these statutory Commissions the responsibility of regulating this sector

### **Environment Impact Assessment Notifications**

The Environment Impact Assessment Notification S.O.60(E), issued on January 27, 1994 ("1994 Notification") under the provisions of the Environment Act, as amended, prescribes that for the construction of certain power projects specified in the 1994 Notification, in the case of new projects, if the investment is more than `1,000 million and in the case of expansion or modernization projects, if the investment is more than `500 million the prior environmental clearance of the Ministry of Environment and Forest ("MoEF") is required. The environmental clearance must be obtained from the MoEF according to the procedure specified in the 1994 Notification. No construction work, preliminary or other, relating to the setting up of a project can be undertaken until such clearance is obtained.

The application to the MoEF is required to be accompanied by a project report which should include, *inter alia*, an Environmental Impact Assessment Report and an Environment Management Plan. The Impact Assessment Authority evaluates the report and plan submitted. Such assessment is required to be completed within a period of 90 days from receipt of the requisite documents from the project developer / manager. Thereafter, a public hearing has to be completed and a decision conveyed within thirty days.

The clearance granted is valid for a period of five years from the commencement of the construction or operation of the project. The project developer / manager concerned are required to submit a half yearly report to the Impact Assessment Authority to enable it to effectively monitor the implementation of the recommendations and conditions subject to which the environmental clearance has been given. If no comments from the Impact Assessment Authority are received within the time limits specified above, the project will be deemed to have been approved by the project developer / manager.

On September 14, 2006, the Environmental Impact Assessment Notification S.O. 1533 (“2006 Notification”) superseded the 1994 Notification. Under the 2006 Notification, the environmental clearance process for new projects consists of four stages – screening, scoping, public consultation and appraisal. After completion of public consultation, the applicant is required to make appropriate changes in the draft Environment Impact Assessment Report and the Environment Management Plan. The final Environment Impact Assessment Report has to be submitted to the concerned regulatory authority for appraisal. The regulatory authority is required to give its decision within 105 days of the receipt of the final Environment Impact Assessment Report.

### **The Hazardous wastes (Management and Handling) Rules, 1989**

The Hazardous Wastes (Management, Handling and Trans boundary Movement) Rules, 2008, as amended (the "Hazardous Wastes Rules"), which superseded the Hazardous Wastes (Management and Handling) Rules, 1989, state that the occupier will be responsible for safe and environmentally sound handling of hazardous wastes generated in his establishment. The hazardous wastes generated in the establishment of the occupier should be sent or sold to a recycler or re-processor or re-user registered or authorized under the Hazardous Wastes Rules or should be disposed of in an authorized disposal facility. The MOEF has been empowered to deal with the trans-boundary movement of hazardous wastes and to grant permission for transit of hazardous wastes through any part of India. No import of hazardous waste is permitted in India. The State Government, occupier, operator of a facility or any association of the occupier will be individually or jointly or severally responsible for, and identify sites for, establishing the facility for treatment, storage and disposal of hazardous wastes for the State.

### **Public Liability Insurance Act, 1991 (“Public Liability Act”)**

The Public Liability Act imposes liability on the owner or controller of hazardous substances for any damage arising out of an accident involving such hazardous substances. A list of hazardous substances covered by the legislation has been enumerated by the Government by way of a notification. The owner or handler is also required to take out an insurance policy insuring against liability under the legislation. The rules made under the Public Liability Act mandate that the employer has to contribute towards the Environment Relief Fund, a sum equal to the premium paid on the insurance policies. This amount is payable to the insurer.

## **F. LABOUR LAWS**

### **Factories Act, 1948**

The Factories Act, 1948 (“Factories Act”) defines a ‘factory’ to cover any premises which employs ten or more workers and in which manufacturing process is carried on with the aid of power and covers any premises where there are atleast 20 workers whom are may not been engaged in an electrically aided manufacturing process. Each State Government has rules in respect of the prior submission of plans and their approval for the establishment of factories and registration and licensing of factories.

The Factories Act provides that the occupier of a factory, *i.e.* the person who has ultimate control over the affairs of the factory and in the case of a company, anyone of the directors, must ensure the health, safety and welfare of all workers especially in respect of safety and proper maintenance of the factory such that it does not pose health risks, the safe use, handling, storage and transport of factory articles and substances, provision of adequate instruction, training and supervision to ensure workers’ health and safety, cleanliness and safe working conditions. Persons who design, manufacture, import or supply articles for use in a factory must ensure the safety of the workers in the factory where the articles are used. If the safety standards of the country where the articles are manufactured are above Indian safety standards, the articles must conform to the relevant foreign standards. There is a prohibition on employing children below the age of fourteen years in a factory. If there is violation of any provisions of the Factories Act or rules framed there under, the occupier and manager of the factory may be punished with imprisonment for a term up to two years and/or with a fine up to ₹1 lakhs or both, and in case of such violation continuing after conviction, with a fine of up to ₹1,000 per day of violation. In case of a contravention which results in death or serious bodily injury, the fine shall not be less than ₹0.25 lakhs in the case of an accident causing death, and ₹5,000 in the case of an accident causing serious bodily injury. In case of contravention after a prior conviction, the term of imprisonment increases upto three years and the fine would be ₹ 3 lakhs and in case such contravention results in death or serious bodily injury the fine would be a minimum of ₹ 0.35 lakhs and ₹ 0.10 Lakhs, respectively.

The ambit of operation of this Act includes the approval of Factory Building Plans before construction/extension, investigation of complaints with regard to health, safety, welfare and working conditions of the workers employed in a factory, the maintenance of registers and the submission of yearly and half-yearly returns.

### **Minimum Wages Act, 1948**

The State Governments may stipulate the minimum wages applicable to a particular industry. The minimum wages generally consist of a basic rate of wages, cash value of supplies of essential commodities at concession rates and a special allowance, the aggregate of which reflects the cost of living index as notified in the Official Gazette. Workers are to be paid for overtime at overtime rates stipulated by the appropriate State Government. Any contravention may result in imprisonment of upto six months or a fine of upto ₹500.

### **Employees' Compensation Act, 1923**

The Employee's Compensation Act, 1923 has been enacted with the objective to provide for the payment of compensation by certain classes of employers to their workmen or their survivors for industrial accidents and occupational diseases resulting in the death or disablement of such workmen. The Act makes every employer liable to pay compensation in accordance with the Act if a personal injury/disablement/loss of life is caused to a workman (including those employed through a contractor) by an accident arising out of and in the course of his employment. In case the employer fails to pay compensation due under the Act within one month from the date it falls due, the Commissioner may direct the employer to pay the compensation amount along with interest and may also impose a penalty.

### **Payment of Wages Act 1936**

The Payment of Wages Act applies to the persons employed in the factories and to persons employed in industrial or other establishments where the monthly wages payable to such persons is less than ₹10,000/-. The Act confers on the person(s) responsible for payment of wages certain obligations with respect to the maintenance of registers and the display in such factory/establishment, of the abstracts of this Act and Rules made there under.

### **Industrial (Development and Regulation) Act, 1955**

The Industrial (Development and Regulation) Act, 1951 has been liberalized under the New Industrial Policy dated July 24, 1991, and all industrial undertakings are exempt from licensing except for certain industries such as distillation and brewing of alcoholic drinks, cigars and cigarettes of tobacco and manufactured tobacco substitutes, all types of electronic aerospace and defense equipment, industrial explosives including detonating fuses, safety fuses, gun powder, nitrocellulose and matches and hazardous chemicals and those reserved for the small scale sector.

An industrial undertaking, which is exempt from licensing, is required to file an Industrial Entrepreneurs Memorandum ("IEM") with the Secretariat for Industrial Assistance, Department of Industrial Policy and Promotion, Ministry of Commerce and Industry, Government of India, and no further approvals are required.

### **The Employees State Insurance Act, 1948**

All the establishments to which the Employees State Insurance (ESI) Act applies are required to be registered under the Act with the Employees State Insurance Corporation. The Act applies to those establishments where 20 or more persons are employed. The Act requires all the employees of the factories and establishments to which the Act applies to be insured in the manner provided under the Act. Further, employer and employees both are required to make contribution to the fund. The return of the contribution made is required to be filed with the ESI department.

### **Payment of Gratuity Act, 1972**

Gratuity is a lump sum payment made by an employer as the retrial reward for his past service when his employment is terminated. The provisions of the Act are applicable on all the establishments in which ten or more employees were employed on any day of the preceding twelve months and as notified by the government from time to time. The Act provides that within 30 days of opening of the establishment, it has to notify the controlling authority in Form A thereafter whenever there is any change in the name, address or in the change in the nature of the business of the establishment a notice in Form B has to be filed with authority. An employee

who has been in continuous service for a period of five years will eligible for gratuity upon his retirement, superannuation, death or disablement. The maximum amount of gratuity payable shall not exceed ` 3.50 Lakhs. Further, every employer has to obtain insurance for his liability towards gratuity payment to be made under payment of Gratuity Act 1972, with Life Insurance Corporation or any other approved insurance fund.

### **Payment of Bonus Act, 1965**

The Payment of Bonus Act, 1965 is applicable to every establishment employing 20 or more employees. Under the said Act an employee in a factory who has worked for atleast 30 working days in a year is eligible to be paid bonus. The minimum bonus to be paid to each employee is 8.33% of the salary or wage or `100, whichever is higher, and must be paid irrespective of the existence of any allocable surplus. If the allocable surplus exceeds minimum bonus payable, then the employer must pay bonus proportionate to the salary or wage earned during that period, subject to a maximum of 20% of such salary or wage. Contravention of the Act by a company will be punishable by proceedings for imprisonment upto six months or a fine upto `1,000 or both against those individuals in charge at the time of contravention of the Payment of Bonus Act. It further requires for the maintenance of certain books and registers and submission of Annual Return in the prescribed form (FORM D) within 30 days of payment of the bonus to the Inspector.

### **The Employees Provident Fund and Miscellaneous Provisions Act, 1952 (“Act”) and the schemes formulated there under (“Schemes”)**

The Act is applicable to factories employing more than 20 employees and may also apply to such establishments and industrial undertakings as notified by the Government from time to time. All the establishments under the Act are required to be registered with the Provident Fund Commissioners of the State. The Employees Provident Fund and Miscellaneous Provisions Act, 1952 provides for the institution of compulsory provident fund, pension fund and deposit linked insurance fund for the benefit of employees in factories and other establishments. Accordingly, the following schemes are formulated for the benefit of such employees:

i. *The Employees Provident Fund Scheme:* As per this Scheme, a provident fund is constituted and both the employees and employer contribute to the fund at the rate of 12% (or 10% in certain cases) of the basic wages, dearness allowance and retaining allowance, if any, payable to employees per month.

ii. *The Employees Pension Scheme:* Employees’ Pension Scheme is Pension Scheme for survivors, old aged and disabled persons. This Scheme derives its financial resource by partial diversion from the Provident Fund contribution, the rate being 8.33%. Thus, a part of contribution representing 8.33 per cent of the employee’s pay shall be remitted by the employer to the Employees’ Pension fund within 15 days of the close of every month by a separate bank draft or cheque on account of the Employees’ Pension Fund contribution in such manner as may be specified in this behalf by the appropriate authority constituted under the Act. The Central Government shall also contribute at the rate of 1.16 per cent of the pay of the members of the Employees’ Pension Scheme and credit the contribution to the Employees’ Pension Fund.

iii. *The Employees Deposit Linked Insurance Scheme:* As per this Scheme, the contribution by the employer shall be remitted by him together with administrative charges at such rate as the Central Government may fix from time to time under Section 6C (4) of the Act, to the Insurance Fund within 15 days of the close of every month by a separate bank draft or cheque or by remittance in cash in such manner as may be specified in this behalf by the appropriate authority constituted under the Act.

### **Industrial Disputes Act, 1947**

The Industrial Disputes Act, 1947 (“Industrial Disputes Act”) provides for mechanism and procedure to secure industrial peace and harmony by investigation and settlement of industrial disputes by negotiations. The Industrial Disputes Act extends to whole of India and applies to every industrial establishment carrying on any business, trade, manufacture or distribution of goods and services irrespective of the number of workmen employed therein. Every person employed in an establishment for hire or reward including contract labour, apprentices and part time employees to do any manual, clerical, skilled, unskilled, technical, operational or supervisory work, is covered by the Act. The Act also provides for (a) the provision for payment of compensation to the Workman on account of closure or layoff or retrenchment. (b) the procedure for prior permission of appropriate Government for laying off or retrenching the workers or closing down industrial establishments (c) restriction on unfair labour practices on part of an employer or a trade union or workers.

### **Industrial Employment (Standing Orders) Act, 1946**

The Industrial Employment (standing orders) Act requires employers in industrial establishments to formally define conditions of employment under them. It applies to every industrial establishment wherein 100 (reduced to 50 by the Central Government in respect of the establishments for which it is the Appropriate Government) or more workmen are employed. The Act calls for the submission of such conditions of work to the relevant authorities for their approval.

### **The Equal Remuneration Act, 1976 and Equal Remuneration Rules, 1976**

The Constitution of India provides for equal pay for equal work for both men and women. To give effect to this provision, the Equal Remuneration Act, 1976 was implemented. The Act provides for payment of equal wages for equal work of equal nature to male or female workers and for not making discrimination against female employees in the matters of transfers, training and promotion etc.

### **The Maternity Benefit Act, 1961**

The purpose of Maternity Act 1961 is to regulate the employment of pregnant women and to ensure that they get paid leave for a specified period during and after their pregnancy. It provides inter-alia for payment of maternity benefits, medical bonus and enacts prohibition on dismissal, reduction of wages paid to pregnant women etc. It applies in the first instance, to every establishment being a factory, mine or plantation [including any such establishment belonging to Government and to every establishment wherein persons are employed for the exhibition of equestrian, acrobatic and other performances.

### **Apprentices Act, 1961**

The Apprentices Act was enacted in 1961 for imparting training to apprentices i.e. a person who is undergoing apprenticeship training in pursuance of a contract of apprenticeship. Every employer shall make suitable arrangements in his workshop for imparting a course of practical training to every apprentice engaged by him in accordance with the programme approved by the apprenticeship adviser. The central apprenticeship adviser or any other person not below the rank of an assistant apprenticeship adviser shall be given all reasonable facilities for access to each apprentice with a view to test his work and to ensure that the practical training is being imparted in accordance with the approved programme.

### **Child Labour (Prohibition and Regulation) Act, 1986**

This statute prohibits employment of children below 14 years of age in certain occupations and processes and provides for regulation of employment of children in all other occupations and processes. Under this Act the employment of child labour in the building and construction industry is prohibited.

### **Trade Union Act, 1926 and Trade Union (Amendment) Act, 2001**

Provisions of the Trade Union Act, 1926 provides that any dispute between employers and workmen or between workmen and workmen, or between employers and employers which is connected with the employment, or non-employment, or the terms of employment or the conditions of labour, of any person shall be treated as trade dispute. For every trade dispute a trade union has to be formed. For the purpose of Trade Union Act, 1926, Trade Union means combination, whether temporary or permanent, formed primarily for the purpose of regulating the relations between workmen and employers or between workmen and workmen, or between employers and employers, or for imposing restrictive condition on the conduct of any trade or business etc.

### **The Contract Labour (Regulation and Abolition) Act, 1970**

The Contract Labour (Regulation and Abolition) Act regulates the employment, and protects the interests, of workers hired on the basis of individual contracts in certain establishments. In the event any activity is outsourced, and is carried out by labourers hired on contractual basis, compliance with the Act including registration will be necessary and the principal employer will be held liable in the event of default by the contractor to make requisite payments towards provident fund. The Act regulates the employment of contract labour in certain establishments provides for its abolition in certain circumstances. It applies:

- To every establishment which does not carry on intermittent / casual work in which twenty or more workmen are / were employed on any day of the preceding 12 months as contract labour (“Establishment”);
- To every contractor who employs, or who employed on any day of the preceding 12 months, twenty or more workmen.

Every Establishment must, within the specified period, apply to the registering officer for registration of the Establishment and obtain a certificate of registration containing such particulars as may be prescribed.

Further, a contractor can only undertake or execute any work through contract labour under and in accordance with a licence issued in that behalf by the licensing officer. The license may contain conditions including, in particular, conditions as to hours or work, fixation of wages and other essential amenities in respect of contract labour. The license will be valid for the period specified therein.

Every contractor is duty-bound to provide and maintain supply of drinking water, canteens, rest-rooms latrines and urinals, washing facilities, first-aid box in the prescribed manner for contract labour employed in connection with the work of an Establishment to which the Act applies. If such amenities are not provided by the contractor within the prescribed time, such amenities shall be provided by the principal employer of the Establishment. Contractor shall be responsible for payment of wages to each worker employed by him as contract labour within the prescribed period and in case he fails to do so, the principal employer of the Establishment will be so responsible. Every principal employer and contractor is required to maintain the prescribed records in respect of the contract labour employed.

### **The Contract Labour (Regulation and Abolition) Central Rules, 1971**

The Contract Labour Rules were formulated to carry out the purposes of the Contract Labour (Regulation and Abolition) Act, 1970 ("Act") has not been captured. As per the Contract Labour Rules, the application for registration of establishments to which the Act applies shall be made in Form I in triplicate and shall be accompanied by a treasury receipt showing payment of fees. A certificate of registration in Form II containing particulars of the name of the establishment, type of work carried on therein, number of contract labourers employed and other particulars is then issued. Any change in these particulars must be intimated by the principal employer at the establishment within thirty days of such change along with details of such change. Every application for license by the Contractor, made in Form IV, shall be accompanied by a certificate by the principal employer in Form V to the effect that the applicant has been employed by him as a contractor in relation to his establishment. Security as prescribed must also be deposited. Every license granted to the contractor in Form VI i- non-transferable and shall contain particulars such as the maximum number of contract labourers employed.

Further, the employer is required to maintain records and submit periodic returns with regard to the implementation of the Act and Schemes.

### **The Sexual Harassment of Women at Workplace (Prevention, Prohibition and Redressal) Act, 2013 ("SHWW Act")**

The Sexual Harassment of Women at Workplace (Prevention, Prohibition and Redressal) Act, 2013 provides for the protection of women at work place and prevention of sexual harassment at work place. The Act also provides for a redressal mechanism to manage complaints in this regard. Sexual harassment includes one or more of the following acts or behaviour namely, physical contact and advances or a demand or request for sexual favours or making sexually coloured remarks, showing pornography or any other unwelcome physical, verbal or non-verbal conduct of sexual nature. The Act makes it mandatory for every employer of a workplace to constitute an Internal Complaints Committee which shall always be presided upon by a woman. It also provides for the manner and time period within which a complaint shall be made to the Internal Complaints Committee i.e. a written complaint is to be made within a period of 3 (three) months from the date of the last incident. If the establishment has less than 10 (ten) employees, then the complaints from employees of such establishments as also complaints made against the employer himself shall be received by the Local Complaints Committee. The penalty for non-compliance with any provision of the SHWW Act shall be punishable with a fine extending to Rs 50,000/- (Rupees Fifty Thousand Only).

## **G. TAX LAWS**

### **Income Tax Act, 1961**

The Income Tax Act, 1961 deals with the taxation of individuals, corporate, partnership firms and others. As per the provisions of this Act the rates at which they are required to pay tax is calculated on the income declared by them or assessed by the authorities, after availing the deductions and concessions accorded under the Act. The maintenance of Books of Accounts and relevant supporting documents and registers are mandatory under the Act. Filing of returns of Income is compulsory for all assesses. The maintenance of Books of Accounts and relevant supporting documents and registers are mandatory under the Act.



**Madhya Pradesh Value Added Tax (“MPVAT”)**

VAT is a system of multi-point levy on each of the purchases in the supply chain with the facility of set-off input tax on sales whereby tax is paid at the stage of purchase of goods by a trader and on purchase of raw materials by a manufacturer. VAT is based on the value addition of goods, and the related VAT liability of the dealer is calculated by deducting input tax credit for tax collected on the sales during a particular period. VAT is a consumption tax applicable to all commercial activities involving the production and distribution of goods and the provisions of services, and each state that has introduced VAT has its own VAT Act, under which, persons liable to pay VAT must register and obtain a registration number from Sales Tax Officer of the respective State.

**Madhya Pradesh Professional Tax Act, 1995**

An act to provide for levy of tax on profession, trades, callings and employments in the state of Madhya Pradesh. It is applicable to all the employees defined under section 2 (c) of the act. —Employees means a person employed on [salary or wage]. "Employer" in relation to an employee earning any [salary or wage] on regular basis under him means the person or the officer who is responsible for disbursement of such [salary or wage] and includes the head of the office or an establishment as well as the manager or agent of the employer; "Person" means any person who is engaged in any profession, trade, calling or employment in the State of Madhya Pradesh and includes a Hindu undivided family, firm, company, corporation or other corporate body, any society, club or association so engaged but does not include any person who earns [salary or wage] on casual basis. If the Act is applicable a Certificate of Registration is to be obtained by the Employer under the act.

**Madhya Pradesh Commercial Tax Act, 1994**

The Act is alternately called as Madhya Pradesh Vanijyik Kar Adhiniyam, 1994. As per Section 5 of the Act the incidence of tax is on 1) every dealer whose turnover during a period of twelve months immediately preceding the commencement of this Act exceeds the limit specified in sub-section (5), shall from such commencement be liable to pay tax under this Act in respect of sales or supplies of goods effected in Madhya Pradesh. (2) Every dealer to whom sub-section (1) does not apply shall be liable to pay tax under this Act in respect of sales or supplies of goods effected in Madhya Pradesh with effect from the date on which his turnover in a year first exceeds the limit specified in subsection (5) but for the purpose of assessment of the tax only so much of his turnover as is in excess of such limit, shall be taken into consideration. (3) Every dealer who is liable to pay tax under this Act shall continue to be so liable until the expiry of two consecutive years during each of which his turnover has not exceeded the limits specified in sub-section (5) and till such further period thereafter as may be prescribed and on the expiry of this later period his liability to pay tax shall cease. (4) Every dealer whose liability to pay tax under this Act has ceased under subsection (3) shall, if his turnover calculated from the commencement of any year again exceeds the limit specified in subsection (5), be liable to pay tax under subsection (2).(5)

In Madhya Pradesh the Commercial Tax Act, 1994 applies to the Chemical fertilizers thus it falls under entry 21, Schedule 2, Part 5 of the Act. The tax rate for the same is 4%.

**Service Tax**

Service tax is charged on taxable services as defined in Chapter V of Finance Act, 1994, (as amended from time to time) which requires a service provider of taxable services to collect service tax from a service recipient and pay such tax to the Government. In accordance with Rule 6 of Service tax Rules the assesses is required to pay Service tax in TR 6 challan by fifth of the month immediately following the month to which it relates. Further under Rule 7(1) of Service Tax Rules, the company is required to file a half yearly return in Form ST 3 by twenty fifth of the month immediately following the half year to which the return relates.

**Central Excise Act, 1944 and Excise Regulations**

The Central Excise Act, 1944 seeks to impose an excise duty on excisable goods which are produced or manufactured in India. Excise duty is levied on production of goods but the Liability of excise duty arises only on removal of goods from the place of storage, i.e., factory or warehouse. Unless specifically exempted, excise duty is levied even if the duty was paid on the raw material used in production. The rate at which such a duty is imposed is contained in the First Schedule to Central Excise Tariff Act, 1985. However, the Indian Government has the power to exempt certain specified goods from excise duty by notification.

## Customs Regulations

The provisions of the Customs Act, 1962 and rules made there under are applicable at the time of import of goods i.e. bringing into India from a place outside India or at the time of export of goods i.e. taken out of India to a place outside India. Any Company requiring to import or export any goods is first required to get it registered and obtain an IEC (Importer Exporter Code). Imported goods in India attract basic customs duty, additional customs duty and education cess. The rates of basic customs duty are specified under the Customs Tariff Act 1975. Customs duty is calculated on the transaction value of the goods. Customs duties are administered by Central Board of Excise and Customs under the Ministry of Finance. Our Company imports one of the raw material – Rock Phosphate required for manufacturing of BRP & SSP.

## H. Laws relating to Intellectual Property

### The Trademarks Act, 1999 (“Trademarks Act”)

Under the Trademarks Act, a trademark is a mark capable of being represented graphically and which is capable of distinguishing the goods or services of one person from those of others used in relation to goods and services to indicate a connection in the course of trade between the goods and some person having the right as proprietor to use the mark. A ‘mark’ may consist of a device, brand, heading, label, ticket, name signature, word, letter, numeral, shape of goods, packaging or combination of colours or any combination thereof. Section 18 of the Trademarks Act requires that any person claiming to be the proprietor of a trade mark used or proposed to be used by him, must apply for registration in writing to the registrar of trademarks. The trademark, once applied for and which is accepted by the Registrar of Trademarks (“the Registrar”), is to be advertised in the trademarks journal by the Registrar. Oppositions, if any, are invited and, after satisfactory adjudications of the same, a certificate of registration is issued by the Registrar. The right to use the mark can be exercised either by the registered proprietor or a registered user. The present term of registration of a trademark is 10 (ten) years, which may be renewed for similar periods on payment of a prescribed renewal fee.

### Indian Copyright Act, 1957 (Copyright Act)

The Copyright Act governs copyright protection in India. Under the Copyright Act, copyright may subsist in original literary, dramatic, musical or artistic works, cinematograph films, and sound recordings. Following the issuance of the International Copyright Order, 1999, subject to certain exceptions, the provisions of the Copyright Act apply to nationals of all member states of the World Trade Organization.

While copyright registration is not a prerequisite for acquiring or enforcing a copyright, registration creates a presumption favoring ownership of the copyright by the registered owner. Copyright registration may expedite infringement proceedings and reduce delay caused due to evidentiary considerations. Once registered, the copyright protection of a work lasts for 60 years.

The remedies available in the event of infringement of a copyright under the Copyright Act include civil proceedings for damages, account of profits, injunction and the delivery of the infringing copies to the copyright owner.

### The Patents Act, 1970 (Patent Act)

The purpose of the Patent Act in India is to protect inventions. Patents provide the exclusive rights for the owner of a patent to make, use, exercise, distribute and sell a patented invention. The patent registration confers on the patentee the exclusive right to use, manufacture and sell his invention for the term of the patent. An application for a patent can be made by (a) person claiming to be the true and first inventor of the invention; (b) person being the assignee of the person claiming to be the true and first inventor in respect of the right to make such an application; and (c) legal representative of any deceased person who immediately before his death was entitled to make such an application.

### The Designs Act, 2000 (Designs Act)

The objective of Designs Act is to promote and protect the design element of industrial production. It is also intended to promote innovative activity in the field of industries. The Controller General of Patents, Designs and Trade Marks appointed under the Trademarks Act shall be the Controller of Designs for the purposes of the Designs Act. When a design is registered, the proprietor of the design has copyright in the design during ten years from the date of registration.

**Approvals from Local Authorities**

Setting up of a factory or manufacturing entails the requisite planning approvals to be obtained from the relevant Local Panchayat(s) outside the city limits and appropriate Metropolitan Development Authority within the city limits. Consents are also required from the state pollution control board(s), the relevant state electricity board(s), the state excise authorities, sales tax, among others, are required to be obtained before commencing the building of a factory or the start of manufacturing operations.

## HISTORY AND CERTAIN CORPORATE MATTERS

### Brief History and Background

Our Company was originally incorporated on May 14, 2004 as “Krishana Phoschem Limited” vide Registration no. 17-019288/2004-2005 under the provisions of the Companies Act, 1956 with the Registrar of Companies, Rajasthan, Jaipur.

Our Company was originally promoted by Mr. Rooplal Patel, Mrs. Leela Patel, Mr. Jitendra Patel, Mr. Vinod Paliwal, Mrs. Geeta Paliwal, Mr. Narendra Paliwal and Mr. Dilip Kumar Gadia who were the initial subscribers to the Company’s Memorandum and Articles of Association in the year 2004.

In the year 2006, Mr. Roop Lal Patel and Mr. Dilip Gadia resigned from the company and Mr. Shailendra Garg and Mrs. Sonali Garg had become the shareholders and Additional Director of the Company. Later, on June 6, 2007 the Company was taken over by Mr. Praveen Ostwal & Seasons Agro Chem India Pvt. Ltd and Mr. Pankaj Ostwal, Mr. Praveen Ostwal, Mr. Basant Patwa, Sudha Patwa, Nitu Ostwal, Ekta Jain, Seasons Agro Chem India Pvt. Ltd became the shareholders of the Company.

Presently Mr. Praveen Ostwal, Ostwal Phoschem (India) Limited and Seasons Agro Chem India Private Limited are Promoters of the Company.

As on date of this Prospectus, our Company has nineteen (19) shareholders.

For information on our Company’s profile, activities, services, market, growth, technology, managerial competence, standing with reference to prominent competitors, major suppliers, please refer the sections entitled “Industry Overview”, “Our Business”, “Our Management”, “Financial information of the Company” and “Management’s Discussion and Analysis of Financial Condition and Results of Operations” on pages 79, 91, 127, 157 and 192 respectively.

### Address of Registered Office:

The Registered Office of the Company is situated at 5-O-20 Basement R.C Vyas Colony Bhilwara, Rajasthan – 311001, India.

### Changes in Registered Office of the Company since incorporation

The Registered Office of our Company has shifted many times pursuant to takeover and for the sake of better operational efficiency and administrative convenience.

Except as mentioned below, there has not been any change in our Registered Office since incorporation till date of this Prospectus:

From	To	Date of Change	Reason for Change
209, Subhash Nagar, Road No. 4, Udaipur-313001, Rajasthan, India	13, Darshanpura Opp. M.B. College, Udaipur-313001, Rajasthan, India	August 11, 2006	For the better operational efficiency
13, Darshanpura Opp. M.B. College, Udaipur-313001, Rajasthan	B/2, sarvotam Complex Behind Vaishali Apartment Udaipur-313001, Rajasthan, India	July 31, 2007	Since the company was taken over by new management
B/2, sarvotam Complex Behind Vaishali Apartment Udaipur-313001, Rajasthan, India	5-0-2, Basement Office, R.C. Vyas Colony, Bhilwara-311001, Rajasthan	May 30, 2008	For the better operational efficiency as the new management and existing promoters are permanent resident of Bhilwara.
5-0-2, Basement Office, R.C. Vyas Colony, Bhilwara-311001, Rajasthan	5-0-20 Basement R.C Vyas Colony, Bhilwara-311001, Rajasthan	May 1, 2015	For the better operational efficiency

## Our Main Object

The main objects of our Company as set forth in the Memorandum of Association of our Company are as follows:

1. To carry on in India or elsewhere the business to manufacture, produce, process, convert, commercialize, control, compound, develop, distribute, derive, discover, grade, handle, release, manipulate, prepare, promote, supply, import, export, buy, sell turn to account or to act as agent, brokers, concessionaires, consultant, collaborator, job worker or otherwise to deal in all description, characteristics and application of phosphates, insecticides, pesticides, intermediates including seeds and fertilizers and white phosphorous mercuric chloride, mercurous chloride, phosphorous sulfochloride, ethyl-nee diamine, Ortho pheylene diamine, Phosphorous trichloride, trim ethyl phosphate, Phosphorous penta sulphide, monomethylamine, monochloro, acetic acid, methyl dibromide, peranitrometa-cregol, tetra hydrophthalic, anhydride, metaphenoxy benzal dehyde, buteme diol, Methyl chloroformate, cumena, mono-methly-chloro acetoacetamide, chloromethyl buthle ether, di-ethyl chloroacentanilide, dimethylamine, parachlorobenzyl cyanide, dimethyl phosphorochlorideothioate and all kind other chemical based work and other allied goods, material and substances.
2. To purchase, hold, acquire, mines mining lease, mining rights, mining claims and metaliferous lands and explore, search, work, exercise, develop, treat find and to turn to account, ore, all sorts of major and minor minerals, working deposits of all kind of minerals and sub-soil minerals and to crush, win set, quarry, smelt, calcine, refine, dress, preserve, amalgamate, manufacture, manage, manipulate and prepare for market ore, metal and mineral substances of all kind and to carry on metallurgical operations in all its branches. To prepare, process manufacture, assemble, fabricate, cast, fit, press, machine, treat, weld, harden, plate, temper, anneal or any kind of metals and the consequential products.

## Changes in Memorandum of Association

Except as stated below there has been no change in the Memorandum of Association of our Company since its Incorporation:

Sr. No.	Particulars	Date of Meeting	Type of Meeting
1.	The initial authorised share capital increased from Rs. 5,00,000 (Five Lakh) divided into 50,000 equity Shares of Rs. 10 each to Rs. 2,00,00,000 (Two Crore) divided into 20,00,000 Equity shares of Rs. 10 each .	September 06, 2004	EGM
2.	Increase in authorised share capital from Rs. 2,00,00,000 (Two Crore) divided into 20,00,000 equity Shares of Rs. 10 each to Rs. 2,60,00,000 (Two Crore sixty Lakh) divided into 26,00,000 Equity shares of Rs. 10 each .	June 16, 2005	EGM
3.	Increase in authorised share capital from Rs. 2,60,00,000 (Two Crore Sixty Lakh) divided into 26,00,000 equity Shares of Rs. 10 each to Rs. 6,00,00,000 (Six Crore) divided into 60,00,000 Equity shares of Rs. 10 each .	February 14, 2008	EGM
4.	Increase in authorized share capital from Rs. 6,00,00,000 (Six Crore) divided into 60,00,000 (Sixty Lakh) Equity Shares to Rs. 12,00,00,000 (Twelve Crore) divided into 1,20,00,000 (One Crore Twenty Lakh) Equity shares of Rs. 10 each.	March 21, 2011	EGM
5.	Increase in authorized share capital from Rs. 12,00,00,000 (Twelve Crore) divided into 1,20,00,000 (One Crore twenty Lakh) to Rs. 20,00,00,000 (Twenty Crore) divided into 2,00,00,000 (Two Crore) equity shares of Rs. 10 each.	December 26, 2011	EGM
6.	Increase in authorized share capital from Rs. 20,00,00,000 (Twenty Crore) divided into 2,00,00,000 (Two Crore) to Rs. 25,00,00,000 (Twenty Five Crore) divided into 2,50,00,000 (Two Crore Fifty Lakh) equity shares of Rs.10 each.	August 04, 2014	EGM
7.	To Adopt New Set Of Memorandum Of Association containing regulation in conformity with the Companies Act, 2013	September 21, 2015	AGM

## Adopting New Articles of Association of the Company

Our Company has adopted a new set of Articles of Association of the Company, in the Extra-ordinary General Meeting of the Company dated December 19, 2016.

## Key Events and Mile Stones

Year	Key Events / Milestone / Achievements
2004-05	Incorporation of the Company in the name and style of “Krishana Phoschem Limited”
2005-06	Starting commercial production for manufacturing of BRP at Unit - I
2007-08	Company was taken over by Mr. Praveen Ostwal
2008-09	Change in Registered office from Udaipur to Bhilwara, Rajasthan
2012-13	Starting commercial production for manufacturing of SSP at Unit - I
2013-14	Starting commercial production for manufacturing of GSSP at Unit - I Company has received ISO 9001:2008 for manufacturing & Supply of Beneficiated rock phosphate (BRP), Single super Phosphate (SSP) and Granulated Single Super Phosphate (GSSP) from Absolute Quality certification Pvt. Ltd. (Joint accreditation system of Australia & New Zealand (JAS-ANZ)
2016-17	Started Production for manufacturing of H-Acid and other chemicals at Unit - II

## Other Details about our Company

For details of our Company’s activities, products, growth, technology, marketing strategy, competition and our customers, please refer section titled “Our Business”, “Management’s Discussion and Analysis of Financial Conditions and Results of Operations” and “Basis for Offer Price” on pages 91, 192 and 74 respectively of this Prospectus. For details of our management and managerial competence and for details of shareholding of our Promoters, please refer to sections titled "Our Management" and "Capital Structure" beginning on pages 127 and 54 of this Prospectus respectively.

## Acquisition of Business/Undertakings & Amalgamation

Except as disclose in this Prospectus, there has been no acquisition of business/undertakings, mergers, amalgamation since incorporation.

## Holding Company

As on the date of the Prospectus, our Company is not a subsidiary of any company.

## Subsidiary of our Company

Our Company does not have any Subsidiary within the meaning of Section 2 (87) of the Companies Act 2013, as on the date of this Prospectus.

## Capital raising (Debt / Equity)

For details in relation to our capital raising activities through equity, please refer to the chapter titled “Capital Structure” beginning on page 54 of the Prospectus. For details of our Company’s debt facilities, please refer section “Statement of Financial Indebtedness” on page 190 of the Prospectus.

## Time and Cost overruns in setting up projects

There has been no time / cost overrun in setting up projects by our Company.

## Injunction or restraining order

There are no injunctions/ restraining orders that have been passed against the Company.

### Revaluation of Assets

Our Company has not revalued its assets since incorporation except as follows:-

S.No.	Particulars	Date of Revaluation	Amount (in Lacs)
1.	Land & Building, Plant & Machinery, Building	March 2011	1813.60
2.	Plant & Machinery, Land & Building	March 2014	2211.19

### Defaults or Rescheduling of borrowings with financial institutions/banks and Conversion of loans into Equity Shares

There have been no defaults or rescheduling of borrowings with any financial institutions/banks as on the date of the Prospectus. Furthermore, none of the Company's loans have been converted into equity in the past.

### Lock-out or strikes

Our Company has, since incorporation, not been involved in any labour disputes or disturbances including strikes and lockouts. As on the date of this Prospectus, our employees are not unionized.

### Shareholders of our Company:

Our Company has Nineteen (19) shareholders as on the date of this Prospectus. For further details on the shareholding pattern of our Company, please refer to the chapter titled "Capital Structure" beginning on page 54 of the Prospectus.

### Changes in the Management

For details of change in Management, please see chapter titled "Our Management" on page no 127 of the Prospectus.

### Changes in activities of our Company during the last five (5) years

There has been no change in the business activities of our Company during last five (5) years from the date of this Prospectus which may have had a material effect on the profit/loss account of our Company except as mentioned in Material development in chapter titled "Management's discussion and analysis of financial conditions & results of operations" beginning on page 192 of this Prospectus,

### Shareholders Agreements

Our Company has entered into share exchange agreement dated March 24, 2015 with Ostwal Phoschem (India) Limited (OPIL) as buyer of Shares where the buyer agrees purchases the shares of our Company in exchange of issue of shares of OPIL. Except as mentioned there are no subsisting shareholder's agreements among our shareholders in relation to our Company, to which our Company is a party or otherwise has notice of the same as on the date of the Prospectus.

### Collaboration Agreements

As on the date of this Prospectus, our Company is not a party to any collaboration agreements.

### Material Agreement

Our Company has not entered into any material agreement, other than the agreements entered into by it in normal course of its business.

### OTHER AGREEMENTS

#### Non Compete Agreement

Our Company has not entered into any Non-competes Agreement as on the date of filing of this Prospectus.

### **Joint Venture Agreement**

Except the agreements entered in the ordinary course of business carried on or intended to be carried on by us, we have not entered into any other Joint Venture agreement.

### **Strategic Partners**

Except as mentioned in this Prospectus, Our Company does not have any strategic partners as on the date of this Prospectus.

### **Financial Partners**

Our Company does not have any financial partners as on the date of this Prospectus.

### **Corporate Profile of our Company**

For details on the description of our Company's activities, the growth of our Company, please see "Our Business", "Management's Discussion and Analysis of Financial Conditions and Results of Operations" and "Basis of Offer Price" on pages 91, 192 and 74 of this Prospectus.



### OUR MANAGEMENT

**Board of Directors:** As per the Articles of Association, our Company is required to have not less than 3 (Three) Directors and not more than 15 (Fifteen) Directors. Currently, our Company has Five (5) Directors and out of which three (3) are Non-Executive Independent Directors. We confirm that the composition of our Board of Directors is as per requirement of SEBI (Listing Obligations and Disclosure Requirements) Regulations, 2015

The following table sets forth the details regarding our Board of Directors of our Company as on the date of filing of this Prospectus:

Sr. No.	Name, Father's, Age, Designation, Address, Experience, Occupation, Qualifications, Nationality & DIN	Date of Appointment	No. of Equity Shares held & % of Share holding (Pre Offer)	Other Directorships
1.	<b>Mr. Praveen Ostwal</b> <b>Father Name:</b> Mahendra Kumar Ostwal <b>Age:</b> 36 Years <b>Designation:</b> Chairman and Managing Director <b>Address:</b> 5-0-1 R.C. Vyas Colony, Bhilwara – 311001 (Rajasthan) <b>Experience:</b> 14 Years <b>Occupation:</b> Business <b>Qualifications:</b> Chartered Accountant <b>Nationality:</b> Indian <b>DIN:</b> 00412207	Originally appointed on the Board as w.e.f. June 6, 2007  Designated as Managing Director w.e.f March 31, 2008 for a period of 5 years <sup>(i)</sup>  Further appointed as chairman in Extra-Ordinary General Meeting dated December 19, 2016	6,78,500 Equity Shares; 2.72% of Pre- Offer Paid up capital	Madhya Bharat Agro Products Limited
2.	<b>Mr. Sunil Kothari</b> <b>Father Name:</b> Narendra Kumar Kothari <b>Age:</b> 40 Years <b>Designation:</b> Whole Time Director & Chief Financial Officer <b>Address:</b> 30/174 Amlion Ki Bari, Bhilwara-311001 (Rajasthan) <b>Experience:</b> 10 Years <b>Occupation:</b> Service <b>Qualifications:</b> Chartered Accountant <b>Nationality:</b> Indian <b>DIN:</b> 02056569	Originally appointed on the Board w.e.f February 14, 2008.  Designated as Whole Time Director w.e.f April 01, 2009 for a period of 5 yrs <sup>(ii)</sup>  Further designated as CFO in Board Meeting dated July 16, 2014.	Nil	--
3.	<b>Mr. Ashish Kothari</b> <b>Father Name :</b> Sharavan Kumar Kothari <b>Age:</b> 31 Years <b>Designation:</b> Non-Executive Independent Director <b>Address:</b> 32, Kashipuri, Bhilwara-311001(Rajasthan) <b>Experience:</b> 11 Years <b>Occupation:</b> Business <b>Qualifications:</b> Master of Commerce <b>Nationality:</b> Indian <b>DIN:</b> 06411429	Originally appointed on the Board as Additional Non Executive Independent Director vide board Meeting dated March 2, 2015  Regularized as Non-Executive Independent Director in AGM dated September 21, 2015	Nil	--

Sr. No.	Name, Father's, Age, Designation, Address, Experience, Occupation, Qualifications, Nationality & DIN	Date of Appointment	No. of Equity Shares held & % of Share holding (Pre Offer)	Other Directorships
4.	<b>Mr. Pradeep Agarwal</b> <b>Father Name :</b> Madan Lal Agarwal <b>Age:</b> 51 Years <b>Designation:</b> Non-Executive Independent Director <b>Address:</b> 45, Azad Nagar ,Bhilwara-311001 (Rajasthan) <b>Experience:</b> 26 Years <b>Occupation:</b> Business <b>Qualifications:</b> Master of Commerce <b>Nationality:</b> Indian <b>DIN:</b> 06458531	Originally appointed as Additional Non- Executive Independent Director w.e.f. December 17, 2012  Regularized as Non-Executive Independent Director vide EGM dated April 18, 2013 <sup>(iii)</sup>	Nil	--
5.	<b>Mrs. Priyanka Surana</b> <b>Father Name:</b> Surendra Kumar Surya <b>Age:</b> 33 years <b>Designation:</b> Non-Executive Independent Director <b>Address:</b> 107, Rajendra Marg, Bhilwara - 311001 (Rajasthan)- <b>Experience:</b> 10 years <b>Occupation:</b> Business <b>Qualifications-</b> Master of Arts <b>Nationality:</b> Indian <b>DIN:</b> 07679675	Appointed as Non- Executive Independent Director w.e.f. December 19, 2016	Nil	--

<sup>(i)</sup> Further reappointed as Managing Director vide Board Meeting dated March 25, 2013 for a period of 5 years w.e.f March 31, 2013 to March 31, 2018

<sup>(ii)</sup> Further reappointed vide Board Meeting dated February 15, 2014 for a period of 5 years w.e.f April 01, 2014.

<sup>(iii)</sup> Further Re-designated as Non Executive Independent Director not liable to retire by rotation for a period of 5 years in AGM dated September 13, 2014

## **BRIEF PROFILE OF OUR DIRECTORS**

### **1. Mr. Praveen Ostwal, Chairman and Managing Director, Age: 36 Years**

Mr. Praveen Ostwal aged 36 years, is Chairman and Managing Director and also the Promoter of our Company. He is a Chartered Accountant by qualification. He was originally appointed on the Board on June 6, 2007 and further designated as the Managing Director of the Company on March 31, 2008 for a period of 5 years. He has been reappointed as Managing Director at the end of his tenure on March 31, 2013 for a period of 5 years. He is actively engaged in managing the company since takeover. He is young and dynamic person, having 14 years experience in the fertilizer. He has been instrumental in turn-around the company. He supervises, control, guide the day-to-day affairs of the company and lead the company to the goals set by the board of directors of the company.

### **2. Mr. Sunil Kothari, Whole-time Director & CFO , Age: 40 Years**

Mr. Sunil Kothari aged 40 years, is the Whole Time Director & Chief Financial Officer of our Company. He is a Chartered Accountant by qualification. He is associated with our Company since 2008. He assisted in managing the financial matters of the company. He has been appointed as the Chief Financial Officer of the Company with effect from July 16, 2014 and Director with effect from February 14, 2008. He is young and dynamic person, having 10 years experience and he is presently looking into the financial and technical matters of the Company.

**3. Mr. Ashish Kothari, Non Executive Independent Director, Age: 31 years**

Mr. Ashish Kothari aged 31 years is Non Executive Independent Director of our Company and was originally appointed as Additional Non Executive Independent Director on March 2, 2015 and later regularized as Non-Executive Director for a period of 5 years vide Extra-Ordinary General Meeting held on September 21, 2015. He holds Master of Commerce degree. He has vast experience in the field of synthetics, Yarn, project & finance.

**4. Mr. Pradeep Agarwal, Non Executive Independent Director, Age: 51 years**

Mr. Pradeep Agarwal aged 51 years is Non Executive Independent Director in our company and was originally appointed as Additional Non Executive Independent Director on December 17, 2012 and later regularized as Non-Executive Director for a period of 5 years vide Extra-Ordinary General Meeting held on September 21, 2015. He holds Master Degree in Commerce (Business Administration) from University of Ajmer. He has vast experience in the field of project & finance. He is working in Baldawa Textile Private Limited, Bhilwara as Finance Manager since 1990.

**5. Mrs. Priyanka Surana, Non Executive Independent Director, Age: 33 years**

Mrs. Priyanka Surana aged 33 years was appointed as Non-Executive Independent Director in our company and is appointed on December 19 2016. She Holds Master Degree in Arts.

**Confirmations**

- None of our Directors is or was a director of any listed company during the last five years preceding the date of this Prospectus, whose shares have been or were suspended from being traded on the BSE or the NSE, during the term of their directorship in such company.
- None of our Directors is or was a director of any listed company which has been or was delisted from any stock exchange during the tenure of their directorship in such company.
- None of the above mentioned Directors are on the RBI list of willful defaulters as on the date of filling of this Prospectus.
- Further, our Company, our Promoters, persons forming part of our Promoter Group, Directors and person in control of our Company has/ have not been not debarred from accessing the capital market by SEBI or any other Regulatory Authority.

**Nature of any family relationship between any of our Directors:**

None of our present Directors are related to each other within the meaning of section 2 (77) of the Companies Act, 2013.

**Arrangements with major Shareholders, Customers, Suppliers or Others:**

We have not entered into any arrangement or understanding with our major shareholders, customers, suppliers or others, pursuant to which any of our Directors were selected as Directors or members of the senior management.

**Service Contracts:**

The Directors of our Company have not entered into any service contracts with our company which provides for benefits upon termination of their employment.

**Details of Borrowing Powers of Directors**

Our Company has passed a Special Resolution in the Extra Ordinary General Meeting of the members held on March 24, 2014 authorizing the Board of Directors of the Company under Section 180 (1) (c) of the Companies Act, 2013 to borrow from time to time all such money as they may deem necessary for the purpose of business of our Company notwithstanding that money borrowed by the Company together with the monies already borrowed by our Company may exceed the aggregate of the paid up share capital

and free reserves provided that the total amount borrowed by the Board of Directors shall not exceed the sum of Rs. 100 Crore (Rupees Hundred Crore only).

### **Compensation of our Managing Director and Whole Time Directors**

The compensation payable to our Managing Director and Whole-time Directors will be governed as per the terms of their appointment and shall be subject to the provisions of Sections 2(54), 2(94), 188, 196, 197, 198 and 203 and any other applicable provisions, if any of the Companies Act, 2013 read with Schedule V to the Companies Act, 2013 and the rules made there under (including any statutory modification(s) or re-enactment thereof or any of the provisions of the Companies Act, 1956, for the time being in force).

The following compensation has been approved for Managing Director and Whole Time Directors:

<b>Particulars</b>	<b>Mr. Praveen Ostwal</b>	<b>Mr. Sunil Kothari</b>
Re-Appointment/Change in Designation	Resolution dated March 25, 2013	Resolution dated February 15, 2014
Designation	Managing Director	Whole-time Director
Term of Appointment	5 years Not liable to Retire by Rotation	5 years liable to Retire by Rotation
Remuneration	Upto Rs 25,00,000 p.a./-	Upto Rs 10,00,000 p.a./-
Remuneration paid for Year 2015-16	Rs. 24,00,000/-	Rs. 7,39,656/-

### **Bonus or Profit Sharing Plan for our Directors**

We have no bonus or profit sharing plan for our Directors.

### **Sitting Fee**

The Articles of Association of our Company provides that payment of sitting fees to Directors (other than Managing Director & Whole-time Directors) for attending a meeting of the Board or a Committee thereof shall be decided by the Board of Directors from time to time within the applicable maximum limits. Our Board of Directors has resolved in their meeting dated December 20, 2016 for payment to all Non-executive Independent Directors for attending each such meeting of the Board or Committee thereof.

### **SHAREHOLDING OF OUR DIRECTORS IN OUR COMPANY**

<b>Sr. No.</b>	<b>Name of Director</b>	<b>No. of Shares held</b>	<b>Holding in %</b>
1.	Mr. Praveen Ostwal	6,78,500	2.72%
2.	Mr. Sunil Kothari	Nil	Nil
3.	Mr. Ashish Kothari	Nil	Nil
4.	Mr. Pradeep Agarwal	Nil	Nil
5.	Mrs. Priyanka Surana	Nil	Nil

*None of the Independent Directors of the Company holds any Equity Shares of Company as on the date of this Prospectus*

*We do not have any subsidiary and associate company as defined under Section 2(87) & 2(6) of the Companies Act, 2013.*

Our Articles of Association do not require our Directors to hold any qualification Equity Shares in the Company.

### **INTEREST OF DIRECTORS**

All the Directors may be deemed to be interested to the extent of fees payable to them for attending meetings of the Board of Directors or a Committee thereof as well as to the extent of other remuneration and reimbursement of expenses payable to them under the Articles, and to the extent of remuneration paid to them for services rendered as an officer or employee of the Company. For further details, please refer- "Compensation of our Managing Director and Whole time Directors" above, beginning on page 130 of this Prospectus

Our Directors may also be regarded as interested their shareholding and dividend payable thereon, if any, Our Directors are also interested to the extent of Equity Shares, if any held by them in our Company or held by their relatives. Further our Director are also interested to the extent of unsecured loans, if any, given by them to our Company or by their relatives or by the companies/ firms in which they are interested as directors/Members/Partners. Further our Directors are also interested to the extent of loans, if any, taken by them or their relatives or taken by the companies/ firms in which they are interested as Directors/Members/Partners.

All Directors may be deemed to be interested in the contracts, agreements/arrangements entered into or to be entered into by our Company with any Company in which they hold Directorships or any partnership firm in which they are partners.

Except as stated otherwise in this Prospectus, our Company has not entered into any Contract, Agreements or Arrangements during the preceding two years from the date of the Prospectus in which the Directors are interested directly or indirectly and no payments have been made to them in respect of the contracts, agreements or arrangements which are proposed to be entered into with them.

Except as stated in this section “Our Management” or the section titled “Financial information of the Company - Related Party Transactions” beginning on page 127 and 185 respectively of this Prospectus, and except to the extent of shareholding in our Company, our Directors do not have any other interest in our business.

Further except as provided hereunder, our Directors are not interested in our Company in any manner:

Sr. No.	Director	Interest
1.	Mr. Praveen Ostwal	Personal Guarantee of Mr. Praveen Ostwal and his relatives, Mr. Mahendra Ostwal, Mr. Pankaj Ostwal and Mrs. Ekta Jain and Collateral Security of Residential property of Mrs. Ekta Jain against the total borrowings of ₹ 3823.77 Lacs made by our Company from HDFC Bank.

#### Interest in the property of Our Company

Except as disclosed in the chapters titled “Our Business and “Financial Information of the Company – Related Party Transactions” on page no. 91 and 185 respectively of this Prospectus, our Directors do not have any interest in any property acquired two years prior to the date of this Prospectus.

#### CHANGES IN BOARD OF DIRECTORS IN LAST 3 YEARS

Sr. No.	Name	Date & Nature of Change	Reasons for Change
1.	Pradeep Agarwal	Regularized as Non-Executive Independent Director Not liable to retire by Rotation in the AGM dated September 13, 2014	To ensure better Corporate Governance
2.	Ashish Kothari	Appointment as Additional Non-Executive Independent Director in the Board Meeting dated March 02, 2015 Regularized as Non-Executive Independent Director in the AGM dated September 21, 2015	Appointed as Additional Non-Executive Director on the Board To ensure better Corporate Governance
3.	Basant Patwa	Cessation from the board in the Board Meeting dated March 30, 2016	Due to personal reason
4.	Mrs. Priyanka Surana	Appointed as Non-Executive Independent Director in the Board Meeting dated December 19, 2016	To ensure better Corporate Governance

## MANAGEMENT ORGANISATION STRUCTURE

The following chart depicts our Management Organization Structure:-

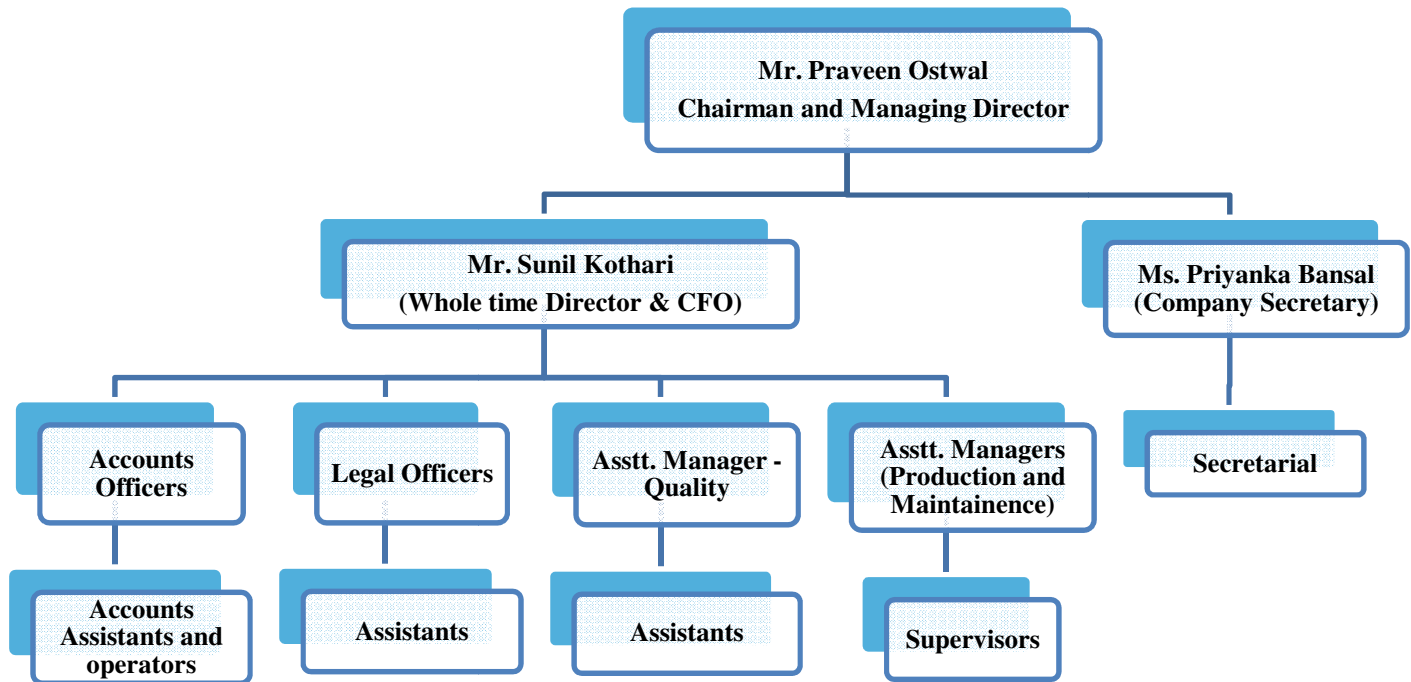

## COMPLIANCE WITH CORPORATE GOVERNANCE

In addition to the applicable provisions of the Companies Act, 2013, provisions of the SEBI (Listing Obligations and Disclosure Requirements) Regulations, 2015 and SEBI (ICDR) Regulations, 2009 in respect of corporate governance will be applicable to our Company immediately upon the listing of our Company's Equity Shares on the SME Platform of NSE. The requirements pertaining to the Composition of the Board of Directors and the constitution of the committees such as the Audit Committee, Stakeholders Relationship Committee and Nomination and Remuneration Committees have been complied with.

Our Board has been constituted in compliance with the Companies Act and the SEBI Listing Regulations and in accordance with the best practices in corporate governance. Our Board functions either as a full board or through various committees constituted to oversee specific operational areas. The executive management provides our Board detailed reports on its performance periodically.

Our Board of Directors consist of Five (5) directors of which three (3) are Non-Executive Independent Directors (as defined under Regulation 16(1) (b) of SEBI (Listing Obligations and Disclosure Requirements) Regulations, 2015), which constitutes more than 50% of the Board of Directors and one women Director, which is in compliance with the requirements of Regulation 17 of SEBI Listing Regulations, 2015. Our Company has constituted the following committees:

### **1. Audit Committee**

Our Company has constituted an Audit Committee ("Audit Committee"), vide Board Resolution dated December 20, 2016, as per the applicable provisions of the Section 177 of the Companies Act, 2013 and also to comply with Regulation 18 of SEBI Listing Regulations, 2015 applicable upon listing of the Company's Equity shares on SME platform of NSE, The constituted Audit Committee comprises following members:

Name of the Director	Status in Committee	Nature of Directorship
Mr. Ashish Kothari	Chairman	Non Executive-Independent Director
Mr. Pradeep Agarwal	Member	Non Executive-Independent Director
Mr. Praveen Ostwal	Member	Chairman & Managing Director

The Company Secretary of our Company shall act as a Secretary to the Audit Committee. The Chairman of the Audit Committee shall attend the Annual General Meeting of our Company to answer shareholder queries. The scope and function of the Audit Committee and its terms of reference shall include the following:

**A. Tenure:** The Audit Committee shall continue to be in function as a committee of the Board until otherwise resolved by the Board, to carry out the functions of the Audit Committee as approved by the Board.

**B. Meetings of the Committee:** The committee shall meet at least four times in a year and not more than 120 days shall elapse between any two meetings. The quorum for the meeting shall be either two members or one third of the members of the committee, whichever is higher but there shall be presence of minimum two Independent members at each meeting.

**C. Role and Powers:** The Role of Audit Committee together with its powers as Part C of Schedule II of SEBI Listing Regulation, 2015 and Companies Act, 2013 shall be as under:

1. Oversight of the listed entity's financial reporting process and the disclosure of its financial information to ensure that the financial statement is correct, sufficient and credible;
2. Recommendation for appointment, remuneration and terms of appointment of auditors of the listed entity;
3. Approval of payment to statutory auditors for any other services rendered by the statutory auditors;
4. Reviewing, with the management, the annual financial statements and auditor's report thereon before submission to the board for approval;
5. Reviewing, with the management, the half yearly financial statements before submission to the board for approval, with particular reference to:
  - matters required to be included in the director's responsibility statement to be included in the board's report in terms of clause (c) of sub-section (3) of Section 134 of the Companies Act, 2013;
  - changes, if any, in accounting policies and practices and reasons for the same;
  - major accounting entries involving estimates based on the exercise of judgment by management;
  - significant adjustments made in the financial statements arising out of audit findings;
  - compliance with listing and other legal requirements relating to financial statements;
  - disclosure of any related party transactions;
  - modified opinion(s) in the draft audit report;
6. Reviewing, with the management, the statement of uses / application of funds raised through an issue (public issue, rights issue, preferential issue, etc.), the statement of funds utilized for purposes other than those stated in the offer document / prospectus / notice and the report submitted by the monitoring agency monitoring the utilization of proceeds of a public or rights issue, and making appropriate recommendations to the board to take up steps in this matter;
7. Reviewing and monitoring the auditor's independence and performance, and effectiveness of audit process;
8. Approval or any subsequent modification of transactions of the listed entity with related parties;
9. Scrutiny of inter-corporate loans and investments;
10. Valuation of undertakings or assets of the listed entity, wherever it is necessary;
11. Evaluation of internal financial controls and risk management systems;
12. Reviewing, with the management, performance of statutory and internal auditors, adequacy of the internal control systems;
13. Reviewing the adequacy of internal audit function, if any, including the structure of the internal audit department, staffing and seniority of the official heading the department, reporting structure coverage and frequency of internal audit;
14. Discussion with internal auditors of any significant findings and follow up there on;
15. The Audit Committee may call for the comments of the auditors about internal control systems, the scope of audit, including the observations of the auditors and review of financial statement before their submission to the Board and may also discuss any related issues with the internal and statutory auditors and the management of the company.
16. Discussing with the statutory auditors before the audit commences, about the nature and scope of audit as well as post-audit discussion to ascertain any area of concern;
17. Reviewing the findings of any internal investigations by the internal auditors into matters where there is suspected fraud or irregularity or a failure of internal control systems of a material nature and reporting the matter to the board;

18. Discussion with statutory auditors before the audit commences, about the nature and scope of audit as well as post-audit discussion to ascertain any area of concern;
19. The Audit Committee shall have authority to investigate into any matter in relation to the items specified in section 177(4) of Companies Act 2013 or referred to it by the Board.
20. To look into the reasons for substantial defaults in the payment to the depositors, debenture holders, shareholders (in case of non-payment of declared dividends) and creditors;
21. To review the functioning of the whistle blower mechanism;
22. Approving the appointment of the Chief Financial Officer (i.e. the whole time finance director or any other person heading the finance function) after assessing the qualifications, experience and background, etc., of the candidate; and;
23. Audit committee shall oversee the vigil mechanism.
24. Audit Committee will facilitate KMP/auditor(s) of the Company to be heard in its meetings.
25. Carrying out any other function as is mentioned in the terms of reference of the audit committee or containing into SEBI Listing Regulations 2015.

Further, the Audit Committee shall mandatorily review the following:

- a) Management discussion and analysis of financial condition and results of operations;
- b) Statement of significant related party transactions (as defined by the audit committee), submitted by management;
- c) Management letters / letters of internal control weaknesses issued by the statutory auditors;
- d) Internal audit reports relating to internal control weaknesses; and
- e) The appointment, removal and terms of remuneration of the chief internal auditor shall be subject to review by the audit committee.
- f) Statement of deviations:
  - Quarterly statement of deviation(s) including report of monitoring agency, if applicable, submitted to stock exchange(s) in terms of Regulation 32(1).
  - Annual statement of funds utilized for purposes other than those stated in the offer document/prospectus/notice in terms of Regulation 32(7).

## 2. Stakeholders Relationship Committee

Our Company has formed the Stakeholders Relationship Committee as per Regulation 20 of SEBI Listing Regulation, 2015 vide Resolution dated December 20, 2016. The constituted Stakeholders Relationship Committee comprises the following:

Name of the Director	Status in Committee	Nature of Directorship
Mr. Pradeep Agarwal	Chairman	Non Executive-Independent Director
Mr. Ashish Kothari	Member	Non Executive-Independent Director
Mr. Praveen Ostwal	Member	Chairman & Managing Director

The Company Secretary of our Company shall act as a Secretary to the Stakeholders Relationship Committee. The scope and function of the Stakeholders Relationship Committee and its terms of reference shall include the following:

- A. Tenure:** The Stakeholders Relationship Committee shall continue to be in function as a committee of the Board until otherwise resolved by the Board, to carry out the functions of the Stakeholders Relationship Committee as approved by the Board.
- B. Meetings:** The Stakeholders Relationship Committee shall meet at least four times a year with maximum interval of four months between two meetings and shall report to the Board on a quarterly basis regarding the status of redressal of complaints received from the shareholders of the Company. The quorum shall be two members present.
- C. Terms of Reference:** Redressal of shareholders' and investors' complaints, including and in respect of:
  - Allotment, transfer of shares including transmission, splitting of shares, changing joint holding into single holding and vice versa, issue of duplicate shares in lieu of those torn, destroyed, lost or defaced or where the space at back for recording transfers have been fully utilized.
  - Issue of duplicate certificates and new certificates on split/consolidation/renewal, etc.;



- Review the process and mechanism of redressal of Shareholders' /Investor's grievance and suggest measures of improving the system of redressal of Shareholders' /Investors' grievances.
- Non-receipt of share certificate(s), non-receipt of declared dividends, non-receipt of interest/dividend warrants, non-receipt of annual report and any other grievance/complaints with Company or any officer of the Company arising out in discharge of his duties.
- Oversee the performance of the Registrar & Share Transfer Agent and also review and take note of complaints directly received and resolved them.
- Oversee the implementation and compliance of the Code of Conduct adopted by the Company for prevention of Insider Trading for Listed Companies as specified in the Securities & Exchange Board of India (Prohibition of insider Trading) Regulations, 2015 as amended from time to time.
- Any other power specifically assigned by the Board of Directors of the Company from time to time by way of resolution passed by it in a duly conducted Meeting, and
- Carrying out any other function contained in the equity listing agreements as and when amended from time to time.

### 3. Nomination and Remuneration Committee

Our Company has formed the Nomination and Remuneration Committee as per Regulation 19 of SEBI Listing Regulation, 2015 vide Resolution dated December 20, 2016 The Nomination and Remuneration Committee comprise the following:

Name of the Director	Status in Committee	Nature of Directorship
Mr. Pradeep Agarwal	Chairman	Non Executive-Independent Director
Mr. Ashish Kothari	Member	Non Executive-Independent Director
Mrs. Priyanka Surana	Member	Non Executive-Independent Director

The Company Secretary of our Company shall act as a Secretary to the Nomination and Remuneration Committee. The scope and function of the Committee and its terms of reference shall include the following:

**A. Tenure:** The Nomination and Remuneration Committee shall continue to be in function as a committee of the Board until otherwise resolved by the Board.

**B. Meetings:** The committee shall meet as and when the need arises for review of Managerial Remuneration. The quorum for the meeting shall be one third of the total strength of the committee or two members, whichever is higher. The Chairperson of the nomination and remuneration committee may be present at the annual general meeting, to answer the shareholders queries; however, it shall be up to the chairperson to decide who shall answer the queries.

#### C. Role of Terms of Reference:

- Identify persons who are qualified to become directors and may be appointed in senior management in accordance with the criteria laid down, recommend to the Board their appointment and removal and shall carry out evaluation of every director's performance;
- Formulate the criteria for determining the qualifications, positive attributes and independence of a director and recommend to the Board a policy relating to the remuneration for directors, KMPs and other employees;
- Formulation of criteria for evaluation of performance of independent directors and the board of directors;
- Devising a policy on diversity of board of directors;
- Whether to extend or continue the term of appointment of the independent director, on the basis of the report of performance evaluation of independent directors;
- Determine our Company's policy on specific remuneration package for the Managing Director / Executive Director including pension rights;
- Decide the salary, allowances, perquisites, bonuses, notice period, severance fees and increment of Executive Directors;
- Define and implement the Performance Linked Incentive Scheme (including ESOP of the Company) and evaluate the performance and determine the amount of incentive of the Executive Directors for that purpose.
- Decide the amount of Commission payable to the Whole time Directors;
- Review and suggest revision of the total remuneration package of the Executive Directors keeping in view the performance of the Company, standards prevailing in the industry, statutory guidelines etc; and
- To formulate and administer the Employee Stock Option Scheme.

#### 4. Corporate Social Responsibility Committee

Our company has pursuant to the provisions of Section 135 of the Companies Act 2013 and Schedule VII constituted a Corporate Social Responsibility Committee of the Board of Directors so formed to undertake the below mentioned tasks:-

- To recommend the policy on Corporate Social Responsibility (CSR) and Implementation of the CSR Projects or program to be undertaken by the company as per the CSR Policy for consideration and approval by the Board of Directors.
- Recommend the amount of expenditure to be incurred on the corporate social responsibility activities; and
- Monitor the implementation of the Company's corporate social responsibility policy.

The Corporate Social Responsibility Committee comprises the following:

Name of the Director	Status in Committee	Nature of Directorship
Mr. Pradeep Agarwal	Chairman	Non Executive-Independent Director
Mr. Sunil Kothari	Member	Whole Time Director
Mr. Ashish Kothari	Member	Non Executive-Independent Director

#### POLICY ON DISCLOSURES AND INTERNAL PROCEDURE FOR PREVENTION OF INSIDER TRADING

The provisions of regulation 9(1) of the SEBI (Prohibition of Insider Trading) Regulations, 2015 will be applicable to our Company immediately upon the listing of its Equity Shares on the SME platform of NSE. We shall comply with the requirements of the SEBI (Prohibition of Insider Trading) Regulations, 2015 on listing of Equity Shares on stock exchanges. Further, Board of Directors at their meeting held on December 20, 2016 have approved and adopted the policy on insider trading in view of the proposed public Offer. Ms. Priyanka Bansal, Company Secretary & Compliance Officer will be responsible for setting forth policies, procedures, monitoring and adherence to the rules for the preservation of price sensitive information and the implementation of the Code of Conduct under the overall supervision of the Board.

#### POLICY FOR DETERMINATION OF MATERIALITY & MATERIALITY OF RELATED PARTY TRANSACTIONS AND ON DEALING WITH RELATED PARTY TRANSACTIONS

The provisions of the SEBI (Listing Obligation and Disclosures) Regulations, 2015 will be applicable to our Company immediately upon the listing of Equity Shares of our Company on SME Platform of NSE. We shall comply with the requirements of the SEBI (Listing Obligation and Disclosures) Regulations, 2015 on listing of Equity Shares on the SME platform of NSE. The Board of Directors at their meeting held on December 20, 2016 have approved and adopted the policy for determination of materiality and determination of materiality of related party transactions and on dealing with related party transactions.

#### Our Key Managerial Personnel

Our Company is supported by a well-laid team having good exposure to various operational aspects of our line of business. A brief about the Key Managerial Personnel of our Company is given below:

Name, Designation & Educational Qualification	Age (Years)	Date of joining as KMP	Compensation paid for the F.Y ended 2016 (in Rs Lacs)	Over all experience (in years)	Previous employment
<b>Name:</b> Mr. Praveen Ostwal <b>Designation:</b> Chairman and Managing Director <b>Qualification:</b> Chartered Accountant	36	Managing Director w.e.f March 31, 2008 & Chairman w.e.f December 19, 2016	24.00	14	Nil
<b>Name:</b> Mr. Sunil Kothari <b>Designation:</b> Whole time Director & Chief Financial Officer <b>Qualification:</b> Chartered Accountant	40	Whole time Director w.e.f April 01, 2009 & CFO since July 16, 2014	7.40	10	Swagat Suiting Pvt. Ltd.

<b>Name:</b> Priyanka Bansal		Appointed	on			
<b>Designation:</b> Company Secretary & Compliance Officer	23	December	14,	--	0.5	Season Agro Chem India Pvt. Ltd.
<b>Qualification:</b> Company Secretary		2016				

## BRIEF PROFILE OF KEY MANAGERIAL PERSONNEL

### 1. Mr. Praveen Ostwal, Chairman cum Managing Director, Age: 36 Years

Mr. Praveen Ostwal aged 36 years, is Chairman cum Managing Director and also the Promoter of our Company. He is a Chartered Accountant by qualification. He was originally appointed on the Board on June 6, 2007 and further designated as the Managing Director of the Company on March 31, 2008 for a period of 5 years. He has been reappointed as Managing Director at the end of his tenure on March 31, 2013 for a period of 5 years. He was actively engaged in managing the company since takeover. He is young and dynamic person, having 14 years experience in the fertilizer as well as textile Sector.

### 2. Mr. Sunil Kothari, Whole-time Director & CFO , Age: 40 Years

Mr. Sunil Kothari aged 40 years, is the Whole Time Director & Chief Financial Officer of our Company. He is a Chartered Accountant by qualification. He is associated with our Company since 2008. He assisted in managing the financial matters of the company. He has been appointed as the Chief Financial Officer of the Company with effect from July 16, 2014 and Director with effect from February 14, 2008. He is young and dynamic person, having 10 years experience and he is presently looking into the financial and technical matters of the Company.

### 3. Ms. Priyanka Bansal, Company Secretary & Compliance Officer, Age: 23 Years

Ms. Priyanka Bansal is Company Secretary and Compliance officer of our Company. She holds a Company Secretary degree from Institute of Company Secretaries of India. She has an overall experience of six months. She looks after the secretarial matters of our Company. She joined our Company on December 14, 2016.

## RELATIONSHIP BETWEEN KEY MANAGERIAL PERSONNEL

None of Key Managerial person stated above are related to each other.

### We confirm that:

- All the persons named as our Key Managerial Personnel above are the permanent employees of our Company.
- There is no understanding with major shareholders, customers, suppliers or any others pursuant to which any of the above mentioned Key Managerial Personnel have been recruited.
- None of our KMPs except Mr. Praveen Ostwal and Mr. Sunil Kothari, are also part of the Board of Directors.
- In respect of all above mentioned Key Managerial Personnel there has been no contingent or deferred compensation accrued for the period ended November 2016.
- Except for the terms set forth in the appointment Letters/Service Agreements the Key Managerial Personnel have not entered into any other contractual arrangements or service contracts (including retirement and termination benefits) with the issuer.
- Our Company does not have any bonus/profit sharing plan for any of the Key Managerial Personnel.
- None of the Key Managerial Personnel in our Company hold any shares of our Company as on the date of filing of this Prospectus except as under:

Sr. No.	Director	Shareholding	In %
1.	Mr. Praveen Ostwal	6,78,500	2.72%

- Presently, we do not have ESOP/ESPS scheme for our employees.
- The turnover of KMPs is not high, compared to the Industry to which our Company belongs.

### Payment of Benefits to Officers of our Company (non-salary related)

Except for any statutory payments made by our Company upon termination of services of its officer or employees, our Company has not paid any sum, any non-salary amount or benefit to any of its officers or to its employees including amounts towards super annuation, ex-gratia/rewards.

### Changes in the Key managerial Personnel in last three years:

There have been no changes in the Key Managerial Personnel of our Company during the last three year except as stated below:

Sr. No.	Name	Designation	Date of Appointment/ Cessation/Promotion/ Transfer	Reasons
1.	Mr. Sunil Kothari	Chief Financial Officer	July 16, 2014	Appointment
2.	Ms. Meenakshi Anchlia	Company Secretary	January 31, 2015	Resignation
3.	Ms. Suryanshi Jain	Company Secretary	May 18, 2015	Appointment
4.	Ms. Priyanka Bansal	Company Secretary	September 30, 2016	Resignation
5.	Mr. Praveen Ostwal	Chairman & Managing Director	December 14, 2016	Appointment
			December 19, 2016	Change in Designation

### INTEREST OF KEY MANAGERIAL PERSONNEL IN OUR COMPANY

Apart from shares held in the Company, and to the extent of remuneration allowed and reimbursement of expenses incurred by them for or on behalf of the Company and to the extent of loans and advances made to or borrowed from the Company, none of our Key managerial personal are interested in our Company, other than as mentioned below:

Sr. No.	Director	Interest
1.	Mr. Praveen Ostwal	Personal Guarantee of Mr. Praveen Ostwal and his relatives, Mr. Mahendra Ostwal, Mr. Pankaj Ostwal and Mrs. Ekta Jain and Collateral Security of Residential property of Mrs. Ekta Jain against the total borrowings of ₹ 3823.77 Lacs made by our Company from HDFC Bank.

Except as provided in this Prospectus, we have not entered into any contract, agreement or arrangement during the preceding 2 (two) years from the date of this Prospectus in which the Key Managerial Personnel are interested directly or indirectly and no payments have been made to them in respect of these contracts, agreements or arrangements or are proposed to be made to them.

For the details unsecured loan taken from or given to our Directors/KMPs and for details of transaction entered by them in the past please refer to “Annexure Q Statement of Related Party Transaction” on page no 185 and Personal Guarantee towards Financial facilities of our Company please refer to “Statement of Financial Indebtedness” on page no 190 of the Prospectus.

### **OTHER BENEFITS TO OUR KEY MANAGERIAL PERSONNEL**

Except as stated in this Prospectus, there are no other benefits payable to our Key Managerial Personnel.

### **EMPLOYEES**

The details about our employees appear under the Paragraph titled —Human Resource in Chapter Titled —Our Business beginning on page 91 of this Prospectus.

## OUR PROMOTERS AND PROMOTER GROUP

### OUR PROMOTER

Mr. Praveen Ostwal, Ostwal Phoschem (India) Limited and Seasons Agro Chem India Private Limited are the Promoters of our Company As on the date of this Prospectus, our Promoters hold 1,28,32,500 Equity Shares which in aggregate, constitutes 51.54 % of the issued and paid-up Equity Share capital of our Company.

**Brief profile of our promoters is as follows:-**



#### Mr. Praveen Ostwal – Managing Director

<b>Qualification</b>	Chartered Accountant
<b>Age</b>	36 Years
<b>Address</b>	5-0-1 R.C. Vyas Colony, Bhilwara – 311001, Rajasthan - India
<b>Experience</b>	14 years
<b>Occupation</b>	Business
<b>Permanent Account Number</b>	AAFPO1733K
<b>Passport Number</b>	F7096892
<b>Name of Bank &amp; Bank Account Details</b>	HDFC Bank A/c No. - 03501000040450
<b>Driving License Number</b>	RJ-06/DLC/09/92194
<b>Voter Identification Card Number</b>	XIU/0204073
<b>Aadhar Card Number</b>	970767917155
<b>No. of Equity Shares held in KPL &amp; [% of Shareholding (Pre Offer)]</b>	6,78,500 Equity Shares; 2.72 % of Pre- Offer Paid up capital
<b>DIN</b>	00412207
<b>Other Interests</b>	<b>Directorships in other Companies:</b> 1. Madhya Bharat Agro Products Limited <b>Partnership Firms:-</b> Nil <b>Proprietorship:-</b> Nil <b>HUF:-</b> 1. Mahendra Kumar Ostwal (HUF) - Member 2. Praveen Ostwal HUF - Karta <b>Trust:-</b> 1. Smt. Nirmala Devi Ostwal Seva Sansthan - Member

### **Details of our Corporate Promoters**

#### ❖ **Seasons Agro Chem India Private Limited (“SAIPL”)**

##### **Corporate Information:**

Seasons Agro Chem India Private Limited (“SAIPL”) was incorporated on June 01, 2004 under the Companies Act, 1956, with the RoC, Rajasthan, Jaipur. The registered office of Seasons Agro Chem India Private Limited is situated at Village-Ojayada, Hamirgarh, Bhilwara, Rajasthan.

The CIN of Seasons Agro Chem India Private Limited is U24219RJ2004PTC019350.

In terms of its Memorandum of Association, the main objects of Seasons Agro Chem India Private Limited are:

1. To carry on the business as manufacturers, processors, importers, exporters, sellers, buyers, dealers, agents, stockiest, wholesalers, distributors, representatives, marketing, of all kinds and types of pesticides, insecticides, bio-fertilizers,

manure, seeds, herbicides, weed sides, chemical fertilizers, urea, plant nutrients, plant hormones, growth promoters, catalysts, activators and growth regulators which can be used in agriculture, horticulture, floriculture, sericulture, animal husbandry, pre and post harvesting agro products, agriculture implements, spares and accessories.

- To carry on the business as manufacturers, processors, exporters, importers, purchasers, sellers, traders, distributors, stockiest, franchise, commission agents and agents for all type of marketing and services, brokers, C and F agents, agency business, industrial and consumer goods, provisions and food stuffs, FMCG, dry fruits, pharmaceuticals, all types of chemical including sulphonic acid, LABSA, LAB, Sulphuric Acid, Zinc Sulphate, Minerals including rock phosphate, beneficiated rock phosphate & single super phosphate etc.

SAIPL is neither a sick company within the meaning of SICA nor has any winding up proceedings been initiated against SAIPL. No application has been made to RoC for striking off its name. Additionally, neither SAIPL nor any of our Group Companies have become defunct in the five years preceding the date of the Prospectus.

Our Promoters, the members of our Group Companies and relatives of our Promoters (as per the Companies Act) have confirmed that they have not been identified as willful defaulters by the RBI or any other governmental authority.

No violations of securities laws have been committed by our Promoters or members of our Promoter Group or any Group Companies in the past or are currently pending against them except as stated under chapters “Risk Factors”, “Our Group Companies” and “Outstanding Litigations and Material Developments” on pages 16, 148 and 205 of this Prospectus, respectively.

None of (i) our Promoters, Promoter Groups or Group Companies or persons in control of or on the boards of bodies corporate forming part of our Group Companies (ii) the Companies with which any of our Promoters are or were associated as a promoter, director or person in control, are debarred or prohibited from accessing the capital markets or restrained from buying, selling, or dealing in securities under any order or directions passed for any reasons by the SEBI or any other authority or refused listing of any of the securities issued by any such entity by any stock exchange in India or abroad except as stated under chapters “Risk Factors”, “Our Group Companies” and “Outstanding Litigations and Material Developments” on pages 16, 148 and 205 of this Prospectus, respectively.

#### **Promoters of Seasons Agro Chem India Private Limited:**

The Promoters of Seasons Agro Chem India Private Limited are Mahendra Kumar Ostwal, Pankaj Ostwal, Praveen Ostwal, Ekta Jain, Nitu Jain, Praveen Ostwal HUF, Pankaj Ostwal HUF

#### **Board of Directors:**

As on the date of this Prospectus, the Board of Directors of Seasons Agro Chem India Private Limited comprises:

Sr. No.	Name of Director	Designation	DIN
1.	Mrs. Ekta Jain	Director	00412561
2.	Mr. Rajendra Kumar Babeel	Director	06376154

#### **Shareholding Pattern**

As of the date of this Prospectus, the authorized share capital of Seasons Agro Chem India Private Limited is ₹ 2,00,00,000 divided into 20,00,000 equity shares of ₹ 10 each.

The shareholding pattern of Seasons Agro Chem India Private Limited as of the date of this Prospectus is as follows:

Name of Shareholder	Number of Equity Shares held	Percentage of Issued Capital (%)
Mr. Praveen Ostwal	381349	19.08
Mrs. Ekta Jain	276048	13.81
Mr. Mahendra Kumar Ostwal	20700	1.04
Praveen Ostwal HUF	287100	14.37
Paneri Textile Pvt. Ltd	62949	3.15

Mr. Nitu Jain	39350	1.97
Mr. Pankaj Ostwal	177600	8.89
Pankaj Ostwal HUF (Karta Pankaj Ostwal)	6000	0.30
Alovera Tradelink Pvt. Ltd.	50000	2.50
Dove Creation Pvt. Ltd.	50000	2.50
Archid Products Pvt. Ltd.	46012	2.30
Mr. Paras Mal Surana	1250	0.06
Ostwal Phoschem (India) Limited	600000	30.02
<b>TOTAL</b>	<b>1998358</b>	<b>100.00</b>

**Financial Information**

The financial performance of Seasons Agro Chem India Private Limited for the last three audited financial years, preceding the date of this Prospectus, is as follows:

*(₹ in Lakhs except per share data)*

Particulars	As on 31 <sup>st</sup> March, 2016	As on March 31, 2015	As on March 31, 2014
Equity Share Capital	139.84	139.84	139.84
Reserves & Surplus (excluding revaluation reserves)	259.46	213.65	174.84
Net Worth	399.30	353.49	314.68
Total Income including other income	755.20	(3.10)	(223.28)
Profit/(Loss) after Tax	45.81	38.81	(237.04)
Earnings Per Share (₹)	3.28	2.78	(16.95)
Net Asset Value Per Share (₹)	28.55	25.28	22.50

**Changes in the management and control of our Corporate Promoter:**

There has been no change in control or management of Seasons Agro Chem India Private Limited in the last three years immediately preceding the date of filing this Prospectus.

**❖ Ostwal Phoschem (India) Limited**
**Corporate Information:**

Ostwal Phoschem (India) Limited was incorporated on January 06, 1989 under the Companies Act, 1956, with the RoC, Rajasthan, Jaipur as Tedco Granite Private Limited. The name was subsequently changed to Tedco Granite Limited pursuant to conversion from a private company to a public company on July 25, 1997 and a fresh certificate of incorporation, was issued by the RoC, Rajasthan, Jaipur on July 25, 1997. The name was further changed to Ostwal Phoschem (India) Limited from Tedco Granite Limited on December 14, 2012 and a fresh certificate of incorporation, was issued by the RoC, Rajasthan, Jaipur on December 14, 2012. The registered office of our company is situated at Village-Ojayada, Hamirgarh, Bhilwara, Rajasthan.

The CIN of Ostwal Phoschem (India) Limited is U26933RJ1989PLC032188.

In terms of its Memorandum of Association, the main objects of Ostwal Phoschem (India) Limited are:

1. To carry on in India or elsewhere the business to manufacture, process, produce, formulate, mix, disinfect, clean, wash, dilute, concentrate compound, segregate, pack, repack, add, remove, heat, grade, freeze, fermentate, reduce, improve, buy, sell, resell, distribute, dispose, handle, market, pro-cure, supply, adatia, stockiest, liasioner, deal in all types of gas based, natural or manmade fertilizers and chemical whether nitrogeous, phosphate, potash or otherwise such as single super phosphate, triple super phosphate, boronated single super phosphate, gradual single super phosphate, phosphate rock, sodium silica fluoride, Lime rock phosphate, urea, sulphur, gypsum, silicon fluoride, vanadium pent oxide, oleum, Sulphuric acid, zinc sulphate, silicon dioxide, phosphoric acid, nitric acid, hydro-chloric acid, soda ash, caustic soda; chlorine, based chemicals, di ammonium phosphate, mono ammonium phosphate, calcium chloride and other organic salts,

by products derivatives, compounds, residues, waste, whether straight, complex or mixed and whether granulated or otherwise and to manufacture, import, export, process, trade in insecticides, pesticides, germicides etc.

OPIL is neither a sick company within the meaning of SICA nor has any winding up proceedings been initiated against OPIL. No application has been made to RoC for striking off its name. Additionally, neither OPIL nor any of our Group Companies have become defunct in the five years preceding the date of the Prospectus.

Our Promoters, the members of our Group Companies and relatives of our Promoters (as per the Companies Act) have confirmed that they have not been identified as willful defaulters by the RBI or any other governmental authority.

No violations of securities laws have been committed by our Promoters or members of our Promoter Group or any Group Companies in the past or are currently pending against them except as stated under chapters “Risk Factors”, “Our Group Companies” and “Outstanding Litigations and Material Developments” on pages 16, 148 and 205 of this Prospectus, respectively.

None of (i) our Promoters, Promoter Groups or Group Companies or persons in control of or on the boards of bodies corporate forming part of our Group Companies (ii) the Companies with which any of our Promoters are or were associated as a promoter, director or person in control, are debarred or prohibited from accessing the capital markets or restrained from buying, selling, or dealing in securities under any order or directions passed for any reasons by the SEBI or any other authority or refused listing of any of the securities issued by any such entity by any stock exchange in India or abroad except as stated under chapters “Risk Factors”, “Our Group Companies” and “Outstanding Litigations and Material Developments” on pages 16, 148 and 205 of this Prospectus, respectively.

**Promoters of Ostwal Phoschem (India) Limited:**

The Promoters of Ostwal Phoschem (India) Limited are Mahendra Kumar Ostwal, Pankaj Ostwal, Praveen Ostwal, R P Ostwal, Ekta Jain , Nitu Jain, Mahendra Kumar Ostwal HUF, Praveen Ostwal HUF, Pankaj Ostwal HUF and Seasons Agro Chem India Pvt Limited.

**Board of Directors:**

As on the date of this Prospectus, the Board of Directors of Ostwal Phoschem (India) Limited comprises:

Name of Director	Designation	DIN
Mahendra Kumar Ostwal	Managing Director	00412163
Rajendra Prasad Ostwal	Director	00412078
Pankaj Ostwal	Director	02586806
Kailash Chandra Shrotriya	Director	06428259
Prabhat Kumar Ranka	Director	06458758
Pramod Kumar Jaketia	Director	07177608

**Shareholding Pattern**

As of the date of this Prospectus, the authorized share capital of Ostwal Phoschem (India) Limited is ₹ 25,00,00,000 divided into 2,50,00,000 equity shares of ₹10 each.

The details of shareholders holding more than 2% of the paid up Equity share capital of Ostwal Phoschem (India) Limited as of the date of this Prospectus is as follows:

Name of Shareholder	Number of Shares held	(Percentage) %
Mahendra Kumar Ostwal	8379325	41.90
Seasons Agro Chem India Private Limited	1525000	7.63
Pankaj Ostwal	1050170	5.25
Kolaveri Textiles Private Limited	828931	4.14
Alovera Tradelink Private Limited	733600	3.67
Shashi Jain & Amita Mehta (Partner Radhay Traders)	700000	3.50



Destiny Exim Private Limited	693983	3.47
Dove Creations Private Limited	601260	3.01
Ekta Jain	581175	2.91
Duggal Tex Private Limited	471928	2.36
M.K. Ostwal HUF	434450	2.17
<b>Total</b>	<b>15999822</b>	<b>80.00</b>

There are 127 shareholders of Ostwal Phoschem (India) Limited and Total paid up equity share capital of the Company is Rs 20,00,00,000 divided into 2,00,00,000 shares of Rs 10/- each

### Financial Information

The financial performance of Ostwal Phoschem (India) Limited for the last three audited financial years, preceding the date of this Prospectus, is as follows:

Particulars	(₹ in Lakhs except per share data)		
	As on 31 <sup>st</sup> March, 2016	As on March 31, 2015	As on March 31, 2014
Equity Share Capital	1725.00	1529.58	1154.26
Reserves & Surplus (excl revaluation reserves)	4321.18	3397.82	2271.01
Net Worth	6046.18	4927.40	3425.27
Total Income including other income	7442.12	6504.38	6662.91
Profit/(Loss) after Tax	452.33	401.89	412.51
Earnings Per Share (₹)	2.93	3.46	3.57
Net Asset Value Per Share (₹) (excluding revaluation reserves)	35.05	32.21	29.67

### Changes in the management and control of our Corporate Promoter:

There has been no change in control or management of Ostwal Phoschem (India) Limited in the last three years immediately preceding the date of filing this Prospectus.

### Confirmations/Declarations

In relation to our individual promoter, Mr. Praveen Ostwal, our Company confirms that the Permanent Account Number, Aadhaar Card Number, Bank Account Number and Passport Number have been submitted to SME Platform of NSE at the time of filing of this Prospectus.

In relation to our Corporate Promoter, Seasons Agro Chem India Private Limited and Ostwal Phoschem (India) Limited, our Company confirms that the Permanent Account Number, Bank Account Number, Company Registration Number and the address of the Registrar of Companies where the companies are registered have been submitted to SME Platform of NSE at the time of filing of this Prospectus.

### Undertaking/ Confirmations

None of our Promoters or Promoter Group or Group Companies or person in control of our Company has been (i) prohibited or debarred from accessing or operating in the capital market or restrained from buying, selling or dealing in securities under any order or direction passed by SEBI or any other authority or (ii) refused listing of any of the securities issued by such entity by any stock exchange, in India or abroad. None of our Promoters, person in control of our Company are or have ever been a promoter, director or person in control of any other company which is debarred from accessing the capital markets under any order or direction passed by the SEBI or any other authority.

Further, neither our Promoters, the relatives of our Promoters (as defined under the Companies Act) nor our Group Companies/entities have been declared as a willful defaulter by the RBI or any other government authority and there are no violations of securities laws committed by them in the past and no proceedings for violation of securities laws are pending against them.

None of our Promoters, Promoter Group Entities or the Group Companies have become sick Companies under the SICA and no application has been made in respect of any of them, to the Registrar of Companies for striking off their names. Further no winding up proceedings have been initiated against the Promoters or the Group Companies.

### **Common Pursuits**

Our Corporate Promoters namely Seasons Agro Chem (India) Private limited and Ostwal Phoschem (India) Limited and our promoter group company namely Madhya Bharat Agro Products Limited are operating in same line of business as of our Company as on date of this Prospectus. Further, our Promoter Mr. Praveen Ostwal has promoted and is on the board of our Promoter Group Companies viz. Madhya Bharat Agro Products Limited.

We cannot assure that our Promoters and Promoter Group or Group Companies will not promote any new entity in the similar line of business and will not favor the interests of the said entities over our interest or that the said entity will not expand their businesses which may increase our chances of facing competition. This may adversely affect our business operations and financial condition of our Company. For further details, please refer section titled “Risk Factors” on page 16 of this Prospectus.

For details of our Promoter Group and Group Companies please refer to section titled “Our Promoter and Promoter Group” and “Our Group Companies” beginning on pages 139 and 148 respectively of this Prospectus.

We shall adopt the necessary procedures and practices as permitted by law to address any conflicting situations, as and when they may arise.

### **Interest of our Promoters**

#### **1. Interest in promotion of Our Company**

Our promoters, as stated herein before, are interested to the extent they have promoted our Company and to the extent of their shareholding in our Company and dividend payable thereon and to the extent of their relatives’ shareholding in our Company. One of our Promoters is also the Managing Director of our Company and may also be deemed to be interested to the extent of his remuneration, as per the terms of their appointment and reimbursement of expenses payable to them and unsecured loan given by them to our Company.

Further, Seasons Agro Chem India Private limited and Ostwal Phoschem (India) Limited, may also have an interest in our Company to the extent of related party transactions entered into with our Company. For details, please refer to Annexure Q on “Related Party Transactions” on page 185 forming part of “Financial Information of the Company” of this Prospectus.

#### **2. Interest in the property of Our Company**

Except as mentioned hereunder, our promoters do not have any other interest in any property acquired by our Company in a period of two years before filing of this Prospectus or proposed to be acquired by us till date of filing the Prospectus with RoC.

<b>Sr. No.</b>	<b>Name of Promoter</b>	<b>Interest and nature of interest</b>
1.	Ostwal Phoschem (India) Limited	The Registered office of the Company which is situated at 5-O-21 Basement R.C Vyas Colony Bhilwara-311001, Rajasthan, India is owned by Ostwal Phoschem (India) Limited and our company has taken it on lease vide Lease Agreement dated May 1, 2015 for a period of 15 years for annual rent of Rs. 5,000/-.
2.	Seasons Agro Chem India Pvt. Ltd.	The Godown of the company situated at Khasra No. 667 and 668, Village Ojayada, Hamirgarh, Dist. Bhilwara, Rajasthan is taken on lease vide Lease Agreement dated December 23, 2015 for a period of 3 years between Seasons Agro Chem India Pvt. Ltd. for Annual rent of Rs. 2,000/-.

#### **3. Interest as members of the Company**

Our Promoters are interested to the extent of their shareholding and the dividend declared in relation to such shareholding, if any, by our Company. For further details in this regard, please refer to “Capital Structure” on page 54 of this Prospectus.

#### 4. Other interests

For transactions in respect of loans and other monetary transactions entered in past please refer Annexure Q on “Related Party Transactions” on page 185, forming part of “Financial Information of the Company” of this Prospectus.

Further, our promoter Mr. Praveen Ostwal may be interested in the credit facilities sanctioned, in favour of our Company, the details of which are:

Sr. No.	Director	Interest
1.	Mr. Praveen Ostwal	Personal Guarantee of Mr. Praveen Ostwal and his relatives, Mr. Mahendra Ostwal, Mr. Pankaj Ostwal and Mrs. Ekta Jain and Collateral Security of Residential property of Mrs. Ekta Jain against the total borrowings of ₹ 3823.77 Lacs made by our Company from HDFC Bank.

For more details of Personal Guarantee given by our promoter towards Financial facilities of our Company please refer to “Statement of Financial Indebtedness” and “Annexure B (B)” of Section “Financial Information of our Company” on page 190 and 157 respectively of this Prospectus.

#### Experience of Promoters in the line of business

Our Promoter Mr. Praveen Ostwal is in the business of fertilizer and chemical manufacturing for about fourteen years. The company shall also endeavour to ensure that relevant professional help is sought as and when required in the future.

#### Related Party Transactions

For the transactions with our Promoters, Promoter Group members and Promoter Group Companies, please refer to section titled “Annexure - Q” of “Related Party Transactions” on page 185 of this Prospectus.

#### Payment or Benefit to Promoters of Our Company

For details of payments or benefits paid to our Promoters, please refer to the paragraph “Compensation of our Managing Director and Whole - time Directors” in the chapter titled “Our Management” beginning on page 127 of this Prospectus. Also refer Annexure Q on “Related Party Transactions” on page 185 forming part of “Financial Information of the Company” and Paragraph on “Interest of Promoters” on page 144 of this Prospectus.

#### Companies / Firms from which the Promoters have disassociated themselves in the last (3) three years

Our Promoters have not disassociated themselves from any of the Companies, Firms or other entities during the last three years preceding the date of this Prospectus.

#### Other ventures of our Promoters

Save and except as disclosed in this section titled “Our Promoters and Promoter Group” and “Our Group Companies” beginning on page 139 & 148 respectively of this Prospectus, there are no ventures promoted by our Promoters in which they have any business interests/ other interests as on date of this Prospectus.

#### Litigation details pertaining to our Promoters

For details on litigations and disputes pending against the Promoters and defaults made by the Promoters please refer to the section titled “Outstanding Litigations and Material Developments” beginning on page 205 of this Prospectus.

## OUR PROMOTER GROUP

In addition to the Promoter named above, the following natural persons and entities form part of our Promoter Group in terms of Regulation 2 (1) (zb) (ii) of SEBI ICDR Regulations, 2009.

Relationship	Mr. Praveen Ostwal
Father	Mr. Mahendra Kumar Ostwal
Mother	Late Smt. Nirmala Ostwal
Spouse	Mrs. Nitu Jain
Brother	Mr. Pankaj Ostwal
Sister	-
Son	Mr. Suryansh Ostwal
Daughter	Ms. Kavya Ostwal
Spouse's Father	Mr. Ashok Parakh
Spouse's Mother	Mrs. Maina Parakh
Spouse's Brother	Mr. Navin Parakh
Spouse's Sister	-

In addition to the above promoter group members, Mrs. Ekta Jain, wife of Mr. Pankaj Ostwal is also the member of Promoter group.

**Our Promoter Group as defined under Regulation 2(1) (zb) of the SEBI (ICDR) Regulations, 2009 includes following entities:**

For Individual Promoters as defined under Regulation 2(1)(zb) (iv) of the SEBI (ICDR) Regulations, 2009:-

Sr. No	Nature of Relationship	Entity
1.	Any Body corporate in which 10% or more of the share capital is held by the Promoter or an immediate relative of the Promoter or a firm or HUF in which the Promoter or any one or more of his immediate relatives is a member	1. Madhya Bharat Agro Products Limited 2. Ostwal Phoschem (India) Limited 3. Seasons Agro Chem India Private Limited 4. Nirmala Realinfrastructure Private Limited 5. Chunri Prints Private Limited 6. Paneri Textiles Private Ltd. 7. Archid Products Private Limited 8. Alovera Tradelink Private Limited 9. Dove Creations Private Limited 10. Destiny Exim Private Limited 11. Duggal Tex Private Limited 12. Kolaveri Textiles Private Limited 13. R.V. Spinners Pvt. Ltd. 14. Kanchi Resorts Pvt. Ltd.
2	Any company in which a company mentioned in (1) above, holds 10% or more, of the equity share capital	Except as disclosed above - Seasons International Pvt. Ltd.
3	Any HUF or Trust or firm in which the aggregate share of the Promoter and his immediate relatives is equal to or more than 10% of the total	<b>Proprietorship:-</b> NIL <b>Firm:-</b> NIL <b>HUF:-</b> 1. Praveen Ostwal HUF 2. Mahendra Kumar Ostwal HUF <b>Trust:-</b> 1. Smt. Nirmala Devi Ostwal Seva Sansthan

**For Corporate Promoter as defined under Regulation 2(1)(zb) (iii) of the SEBI (ICDR) Regulations, 2009:-**

Sr. No	Nature of Relationship	Entity
1.	a subsidiary or holding company of such body corporate	Nil
2.	Anybody corporate in which the promoter holds ten per cent. or more of the equity share capital or which holds ten per cent. or more of the equity share capital of the promoter;	Except as disclosed above - Nil
3.	Anybody corporate in which a group of individuals or companies or combinations thereof which hold twenty per cent. or more of the equity share capital in that body corporate also holds twenty per cent. or more of the equity share capital of the issuer;	Except as disclosed above - Nil

### OUR GROUP COMPANIES

As per the SEBI ICDR Regulations, 2009 for the purpose of identification of Group Companies, our Company has considered companies covered under the Accounting Standard 18 (including Associate Companies) as per Restated Financial Statements. Further, pursuant to a resolution of our Board dated December 20, 2016 for the purpose of disclosure in relation to Group Companies in connection with the Offer, a company shall be considered material and disclosed as a Group Company if Such company forms part of the Promoter Group of our Company in terms of Regulation 2(1)(z)(b) of the SEBI Regulations and Companies who entered into one or more transactions with such company in preceding fiscal or audit period as the case may be exceeding 10% of total revenue of the company as per Restated Financial Statements.

The following entities are identified as Group Companies of our Company:

1. Madhya Bharat Agro Products Limited
2. Seasons International Private Limited
3. Ostwal Phoschem (India) Limited
4. RV Spinners Private Limited
5. Seasons Agro Chem India Private Limited
6. Destiny Exim Private Limited
7. Duggal Tex Private Limited
8. Alovera Tradelink Private Limited
9. Kolaveri Textiles Private Limited
10. Archid Products Private Limited
11. Dove Creations Private Limited
12. Paneri Textiles Private Limited
13. Chunri Prints Private Limited
14. Nirmla Realinfrastructure Private Limited

#### Our Top Five Group Companies including listed Group Company:-

##### **1. Madhya Bharat Agro Products Limited:-**

<b>Date of Incorporation</b>	October 22, 1997
<b>Main objects :</b>	<ol style="list-style-type: none"> <li>1. To carry on in India or elsewhere the business to manufacture, process, produce, refine, convert, commercialize, control, formulate, mix or prepare, enrich mine, disinfect, clean, wash, dilute, concentrate, compound, develop, segregate, pack, repack, add, remove, heat, grade, freeze, fermentate, reduce, improve, buy, sell, resell, e-commerce, exchange, barter, transport, store, forward, distribute, assign, transfer, turn to account or to act as agent, broker, concessionaires, representative consultant, collaborator, job worker or otherwise to deal in all description, characteristics and application, derive, discover, dispose of, trade, handle, release, manipulate prepare, promote, market, procure, supply, treat, import or otherwise acquire, own, hold, use, mortgage, pledge, export, adatia, stockiest, liasioner, deal in and deal with, import and export any and all classes and all kinds and all types and all short of agriculture products, gas based, natural or manmade fertilizers and chemicals, their bye-products.</li> <li>2. To carry on the business as manufacturer, exporter, importer, buyer, purchase, seller, trader, distributor, stockiest, franchise, commission agents, e-commerce for all type of marketing and services, broker, make marketable and otherwise deal in agriculture, horticulture, food stuffs, jute, cotton, woolen, and their items, fibers of textile materials whether agriculture or animal or natural products of manmade, packing materials, carpet, floor covering, furnishing, fabrics, durries, all kind of wood and wooden items, rice, wheat, spices and other food grains and processed and preserved food, fresh food, plant seed, dry fruits, eatable, all kind of</li> </ol>

	edible and non-edible oils, oil seeds and their products, vegetables, vegetable products, dairy products, brewer, horticultural products, flowers, marine products and sea foods, tea, tobacco and tobacco products.		
<b>CIN</b>	U24121RJ1997PLC029126		
<b>PAN Card no.</b>	AADCM5913E		
<b>Registered Office Address</b>	5-O-21, Basement R.C. Vyas Colony Bhilwara Rajasthan-311001 India.		
<b>Board of Directors*</b>	<b>Name</b>	<b>DIN</b>	
	Mr. Pankaj Ostwal	02586806	
	Mr. Praveen Ostwal	00412207	
	Mr. Sourabh Gupta	07177647	
	Mr. Sushil Kumar Surana	01918651	
	Mrs. Paras Mal Surana	06367348	
	Mr. Arvind Kothari	03268623	
	Mrs. Aruna Kothari	07535756	
	<b>For The Year Ended ( Rs. in Lacs, except per share data)</b>		
	<b>March 31, 2016</b>	<b>March 31, 2015</b>	<b>March 31, 2014</b>
<b>Paid Up Equity Share Capital</b>	2190.67	1810.67	1810.67
<b>Reserves and Surplus (excluding Revaluation Reserve and Less Misc. Expenses, if any )</b>	4477.54	2941.21	2576.67
<b>Net worth</b>	6668.21	4751.88	4378.34
<b>Income including other income and exceptional items</b>	6478.25	6842.74	5896.48
<b>Profit/ (Loss) after tax</b>	920.69	390.18	359.79
<b>Earnings per share (face value of Rs. 10 each)</b>	4.61	2.15	3.25
<b>Net asset value per share (Rs)</b>	30.44	26.24	24.18

\*As on date of Prospectus

The Equity shares of Madhya Bharat Agro Products Limited were listed on NSE EMERGE Exchange on September 12, 2016. The company made an Offer for Sale of 57,90,000 equity shares at a price of Rs. 24 each (comprising of face value of Rs. 10 each and a premium of Rs. 14 per equity share) for cash aggregating to Rs. 1389.60 Lakhs. The offer opened for subscription on August 29, 2016 and closed on September 02, 2016. The offer was made to achieve the benefits of listing the Equity Shares on the Stock Exchange. The listing of the Equity Shares will enhance the brand name of the company enabling them to avail future growth opportunities

### Performance vis-à-vis objects

The Equity Shares of Madhya Bharat Agro Products Limited was listed pursuant to Offer for Sale by the existing shareholders, hence the Company did not receive any funds in the Initial Public Offer. The object of the offer was only to achieve the benefits of listing the Equity Shares on the Stock Exchange.

### Share price information

The following table sets forth details of the highest and lowest price on NSE EMERGE since listing:

Sr. No.	Month	Quantum of equity shares traded	Monthly high	Monthly Low
1.	September, 2016	46,68,000	32.00	26.00
2.	October, 2016	8,70,000	41.70	29.60
3.	November, 2016	7,98,000	48.05	34.10

The market capitalisation of Madhya Bharat Agro Products Limited on NSE EMERGE based on the closing price of Rs.46.75 per equity share on December 28, 2016 was Rs. 102.41 crores.

Shareholding Pattern

The following table sets forth details of the shareholding pattern of Madhya Bharat Agro Products Limited as on September 30, 2016:

Category	Category of shareholder	Nos. of shareholders	No. of fully paid up equity shares held	No. of Partly paid-up equity shares held	No. of underlying Depository Receipts	Total nos. shares held	Shareholding as a % of total no. of shares (calculated as per SCRR, 1957) As a % of (A+B+C2)	Number of Voting Rights held in each class of securities*			No. of Shares Underlying Outstanding convertible securities (including Warrants)	Shareholding, as a % assuming full conversion of convertible securities ( as a percentage of diluted share capital) As a % of (A+B+C2)	Number of Locked in shares	Number of Shares pledged or otherwise encumbered	Number of equity shares held in dematerialized form	
								Class Equity Shares of Rs.10/- each^	Class seg:	Total						
I	II	III	IV	V	VI	VII = IV+V+VI	VIII	IX			X	XI=VII+X	XII	XIII	XIV	
(A)	Promoter & Promoter Group	12	1,32,70,735	-	-	1,32,70,735	60.58	1,32,70,735	-	1,32,70,735	60.58	-	60.58	1,32,70,735	100.00	1,32,70,735
(B)	Public	393	86,36,000	-	-	86,36,000	39.42	86,36,000	-	86,36,000	39.42	-	39.42	28,46,000	32.96	86,36,000
(C)	Non Promoter- Non Public	-	-	-	-	-	-	-	-	-	-	-	-	-	-	-
(C1)	Shares underlying	-	-	-	-	-	-	-	-	-	-	-	-	-	-	-
(C2)	Shares held by Emp. Trusts	-	-	-	-	-	-	-	-	-	-	-	-	-	-	-
	<b>Total</b>	<b>405</b>	<b>2,19,06,735</b>	<b>-</b>	<b>-</b>	<b>2,19,06,735</b>	<b>100.00</b>	<b>2,19,06,735</b>	<b>-</b>	<b>2,19,06,735</b>	<b>100.0</b>	<b>-</b>	<b>100.00</b>	<b>1,61,16,735</b>	<b>73.57</b>	<b>2,19,06,735</b>



**Nature and extent of interest of our Promoters**

Sr. No.	Name of our Promoter	No. of Shares held	%age of Shareholding
1	Mr. Praveen Ostwal	3,32,700	1.52
2	Seasons Agro Chem India Private Limited	20,66,790	9.43
3	Ostwal Phoschem (India) Limited	69,26,770	31.62
	<b>Total</b>	<b>93,26,260</b>	<b>42.57</b>

**Mechanism for redressal of investor grievances**

All share related matters, namely transfer, transmission, transposition, dividend, change of name, address and signature of mandate and power of attorney, replacement, split, consolidation, dematerialisation and rematerialisation of shares, issue of duplicate certificates etc. are handled by Madhya Bharat Agro Product Limited's Registrar and Transfer Agent being Bigshare Services Private Limited ("RTA").

Investors correspond with RTA and Madhya Bharat Agro Products Limited on all share related matters. The Board of Directors of Madhya Bharat Agro products Limited has constituted a Shareholder's / Investors Grievance Committee in accordance with SEBI (LODR), 2015 to specifically look into the redressal of complaints of investors such as transfers or credit of shares to demat accounts, non receipt of dividend/ interest/ annual reports, etc.

The Company is neither a sick company within the meaning of the Sick Industrial Companies (Special Provisions) Act, 1985 nor is under winding up.

There are no defaults in meeting any statutory/bank/institutional dues. No proceedings have been initiated for economic offences against the Company.

**2. Seasons International Private Limited.**

<b>Date of Incorporation</b>	July 31, 2008		
<b>Main objects:</b>	To deal in industrial, consumer goods, provisions, food stuffs, FMCG, chemicals and minerals. Handicrafts, garments, precious semi precious stones, marbles, granite, fruits, vegetables, hardware and software. To carry on the business of export and import of graded and raw agri products, value addition in spices, grains, seeds, oil seeds edible non edible, pulses, forest products, medicinal plants and all other Agricultural products. To carry on the business of all types of agri products, machineries for value addition, consultancy for processing, to establish the export house with high technological laboratories, provide technology to Farmers as well as to others.		
<b>CIN</b>	U52190RJ2008PTC027087		
<b>PAN Card no.</b>	AAMCS3739H		
<b>Registered Office Address</b>	5-O-20, First Floor R. C. Vyas Colony Bhilwara Rajasthan 311001 India		
<b>Board of Directors*</b>	<b>Name</b>	<b>DIN</b>	
	Mr. Mukul Kumar Agarwal	02262514	
	Mr. Mahendra Garg	02262765	
	Mr. Suresh Balabux Jain	02736880	
<b>Audited Financial Information</b>	<b>( Rs. in Lacs, except per share data )</b>		
	<b>For The Year Ended</b>		
	<b>March 31, 2016</b>	<b>March 31, 2015</b>	<b>March 31, 2014</b>
<b>Paid up Equity Share Capital</b>	41.56	41.56	41.56
<b>Reserves and Surplus (excluding Revaluation Reserve and Less Misc. Expenses, if any )</b>	741.85	691.32	624.29

<b>Net worth</b>	783.41	732.88	665.85
<b>Income including other income and exceptional items</b>	7807.46	11580.81	7025.65
<b>Profit/ (Loss) after tax</b>	50.52	67.66	54.81
<b>Earnings per share (face value of Rs. 10 each)</b>	12.15	16.28	30.65
<b>Net asset value per share</b>	188.50	176.34	160.21

\*As on date of Prospectus

Shareholding Pattern as on the date of this Prospectus is as follows:

Sr. No.	Name of the Equity Shareholder	No. of Equity Shares held	% of Shareholding
1	Ostwal Phoschem (india) Limited	84513	20.33
2	Sh. Mahendra Garg	58340	14.04
3	Sh. Naresh Chandra Garg	51956	12.50
4	Seasons Agro Chem India Private Limited	41380	9.96
5	Swastik Innovative Syncotex Private Limited	35678	8.58
6	Visulize Tradecom Private Limited	35335	8.50
7	Smt. Nirmala Devi Garg	33200	7.99
8	Smt. Sunita Garg	30000	7.22
9	Smt. Pooja Garg	18000	4.33
10	Sonali Garg	6300	1.52
11	Jyoti Agarwal	5500	1.32
12	Vinod K Jain	5300	1.28
13	Sh. Mukul Kumar Agarwal	5100	1.23
14	Suswani Textiles Private Limited	5022	1.21
	<b>Total</b>	<b>415624</b>	<b>100.00</b>

Nature and extent of interest of our Promoters

Sr. No.	Name of our Promoter	No. of Shares held	% age of Shareholding
1	Mr. Praveen Ostwal	-	-
2	Seasons Agro Chem India Private Limited	41380	9.96
3	Ostwal Phoschem (India) Limited	84513	20.33
	<b>Total</b>	<b>125893</b>	<b>30.29</b>

Seasons International Private Limited is an unlisted Company and it has not made any public issue (including any rights issue to the public) in the preceding three years. It has not become a sick Company under the meaning of SICA nor is under winding up.

There are no defaults in meeting any statutory/bank/institutional dues. No proceedings have been initiated for economic offences against the Company.

### 3. Ostwal Phoschem (India) Limited

For details of Ostwal Phoschem (India) Limited please refer chapter "Our Promoter & Promoter Group" beginning on page 139 of this Prospectus.

### 4. R.V. Spinners Private Limited

<b>Date of Incorporation</b>	February 01, 2002
<b>Main objects:</b>	1. To carry on the business of manufacturers, products, spinners, weavers, knitters, twisters, knitwear, sizers, bleachers, finishers, processors, dyers, labinators, blade, winding, combing, reeling, washing, coloring, dyeing, bleaching, finishing, calendaring, pressers, and processing or otherwise

	dealing in cotton, silk, synthetic, rayon, polyester and their yarns and fibrous substances and to act as importers, exporters, buyers, sellers of and dealers in all kinds of yarns and fabrics whether, cotton, synthetic flax, artificial like nylon, polyester, acrylics, rayon, silk, artificial silk and any other man made fiber or fibrous material.																																						
	2. To carry on the business of manufacturers, producers, ginners, importers, exporters, buyers, sellers in textiles, cotton, rayon, silk, manmade fabrics, fibers, synthetics, woolen, yarn, threads, garments, made up hosiery, canvas, carpets and fabrics, coated and treated with any chemicals and all kinds of ready made garments and their products goods, articles and things as are made from or with cotton, nylon, silk, polyester, acrylics and other kinds of fiber by whatever name called or made under any process, whether natural or artificial and by mechanical or other means and to carry on the business of all kinds of permissible goods and merchandise.																																						
<b>CIN</b>	U17118RJ2002PTC017417																																						
<b>PAN Card no.</b>	AABCR9254R																																						
<b>Registered Office Address</b>	90-91, Indira Market Bhilwara – 311001, Rajasthan, India																																						
<b>Board of Directors*</b>	<table border="1"> <thead> <tr> <th>Name</th> <th>DIN</th> </tr> </thead> <tbody> <tr> <td>Mr. Shanti Lal Kanther</td> <td>00441346</td> </tr> <tr> <td>Mr. Noratan Devi Kanther</td> <td>03371362</td> </tr> </tbody> </table>	Name	DIN	Mr. Shanti Lal Kanther	00441346	Mr. Noratan Devi Kanther	03371362																																
Name	DIN																																						
Mr. Shanti Lal Kanther	00441346																																						
Mr. Noratan Devi Kanther	03371362																																						
<b>Audited Financial Information</b>	<table border="1"> <thead> <tr> <th rowspan="3"></th> <th colspan="3">(Rs. in Lacs, except per share data)</th> </tr> <tr> <th colspan="3">For The Year Ended</th> </tr> <tr> <th>March 31, 2016</th> <th>March 31, 2015</th> <th>March 31, 2014</th> </tr> </thead> <tbody> <tr> <td><b>Paid up Equity Share Capital</b></td> <td>98.15</td> <td>98.15</td> <td>98.15</td> </tr> <tr> <td><b>Reserves and Surplus (excluding Revaluation Reserve and Less Misc. Expenses, if any )</b></td> <td>266.03</td> <td>262.68</td> <td>257.25</td> </tr> <tr> <td><b>Net worth</b></td> <td>364.18</td> <td>360.83</td> <td>355.40</td> </tr> <tr> <td><b>Income including other income and exceptional items</b></td> <td>1150.50</td> <td>2283.55</td> <td>1904.06</td> </tr> <tr> <td><b>Profit/ (Loss) after tax</b></td> <td>0.70</td> <td>2.77</td> <td>6.29</td> </tr> <tr> <td><b>Earnings per share (face value of Rs. 10 each)</b></td> <td>0.07</td> <td>0.28</td> <td>0.64</td> </tr> <tr> <td><b>Net asset value per share</b></td> <td>37.10</td> <td>26.76</td> <td>36.21</td> </tr> </tbody> </table>		(Rs. in Lacs, except per share data)			For The Year Ended			March 31, 2016	March 31, 2015	March 31, 2014	<b>Paid up Equity Share Capital</b>	98.15	98.15	98.15	<b>Reserves and Surplus (excluding Revaluation Reserve and Less Misc. Expenses, if any )</b>	266.03	262.68	257.25	<b>Net worth</b>	364.18	360.83	355.40	<b>Income including other income and exceptional items</b>	1150.50	2283.55	1904.06	<b>Profit/ (Loss) after tax</b>	0.70	2.77	6.29	<b>Earnings per share (face value of Rs. 10 each)</b>	0.07	0.28	0.64	<b>Net asset value per share</b>	37.10	26.76	36.21
	(Rs. in Lacs, except per share data)																																						
	For The Year Ended																																						
	March 31, 2016	March 31, 2015	March 31, 2014																																				
<b>Paid up Equity Share Capital</b>	98.15	98.15	98.15																																				
<b>Reserves and Surplus (excluding Revaluation Reserve and Less Misc. Expenses, if any )</b>	266.03	262.68	257.25																																				
<b>Net worth</b>	364.18	360.83	355.40																																				
<b>Income including other income and exceptional items</b>	1150.50	2283.55	1904.06																																				
<b>Profit/ (Loss) after tax</b>	0.70	2.77	6.29																																				
<b>Earnings per share (face value of Rs. 10 each)</b>	0.07	0.28	0.64																																				
<b>Net asset value per share</b>	37.10	26.76	36.21																																				

\*As on date of Prospectus

Shareholding Pattern as on the date of this Prospectus is as follows:

Sr. No.	Name of the Equity Shareholder	No. of Equity Shares held	% of Shareholding
1	Ekta Jain	250600	25.53
2	Praveen Ostwal	57000	5.81
3	Pankaj Ostwal HUF	33100	3.37
4	Pankaj Ostwal	148600	15.14
5	Mahendra Kumar Ostwal HUF	1000	0.10
6	Shanti Lal Kanther	310200	31.60
7	Noratan Devi Kanther	55000	5.60
8	Seasons Agro Chem India Private Limited	106000	10.80
9	Prem Singh Kothari HUF	10000	1.02
10	Shrawan Kumar Kothari HUF	10000	1.02
	<b>Total</b>	<b>981500</b>	<b>100.00</b>

**Nature and extent of interest of our Promoters**

Sr. No.	Name of our Promoter	No. of Shares held	%age of Shareholding
1	Mr. Pankaj Ostwal	148600	15.14
2	Seasons Agro Chem India Private Limited	106000	10.80
3	Ostwal Phoschem (India) Limited	-	-
<b>Total</b>		<b>254600</b>	<b>25.94</b>

RV Spinners Private Limited is an unlisted Company and it has not made any public issue (including any rights issue to the public) in the preceding three years. It has not become a sick Company under the meaning of SICA nor is under winding up.

There are no defaults in meeting any statutory/bank/institutional dues. No proceedings have been initiated for economic offences against the Company.

**5. Seasons Agro Chem India Private Limited**

For details of Seasons Agro Chem India Private Limited please refer chapter “Our Promoter & Promoter Group” beginning on page 139 of this Prospectus.

**Litigations**

For details on litigations and disputes pending against the Group Company/entities, if any, please refer to the section titled “Outstanding Litigations and Material Developments” on page 205 of this Prospectus.

**Undertaking / confirmations**

None of our Promoters or Promoter Group or Group Companies or person in control of our Company has been

- i. Prohibited from accessing or operating in the capital market or restrained from buying, selling or dealing in securities under any order or direction passed by SEBI or any other authority; or
- ii. Refused listing of any of the securities issued by such entity by any stock exchange, in India or abroad.

None of our Promoters, person in control of our Company or have ever been a Promoter, Director or person in control of any other Company which is debarred from accessing the capital markets under any order or direction passed by the SEBI or any other authority.

Further, neither our Promoters, the relatives of our individual Promoters (as defined under the Companies Act) nor our Group Companies /entities have been declared as a wilful defaulter by the RBI or any other government authority and there are no violations of securities laws committed by them or any entities they are connected with in the past and no proceedings for violation of securities laws are pending against them.

None of our Promoters, Promoter Group or the Group Companies has become sick Companies under the SICA and no application has been made in respect of any of them, to the Registrar of Companies for striking off their names. Further no winding up proceedings have been initiated against the Promoters or the Group Companies.

**Nature and Extent of Interest of Group Companies**
**a) In the promotion of our Company :**

Except for Ostwal Phoschem (India) Limited and Seasons Agro Chem India Private Limited, which is our Corporate Promoter, none of our Group Companies have any interest in the promotion of our Company. For details relating to shareholding or any other business interest, please refer to chapter titled “Capital Structure” on page 54 and “Financial Information of the Company - Annexure Q- Related party Transactions on page 185 of this Prospectus.

**b) In the properties acquired or proposed to be acquired by our Company in the past two years before filing the Prospectus with stock exchange:**

Except as disclosed in this Prospectus, our Group Companies do not have any interest in the properties acquired or proposed to be acquired by our Company in the past two years before filing the Prospectus with Stock Exchange.

**c) In transactions for acquisition of land, construction of building and supply of machinery**

None of our Group Companies are interested in any transactions for the acquisition of land, construction of building or supply of machinery

**Common Pursuits/Conflict of Interest**

Our Promoters namely Ostwal Phoschem (India) Limited and Seasons Agro Chem (India) Private limited are operating in same line of business as our Company as on date of this Prospectus. Also our promoter group company namely Madhya Bharat Agro Products Limited is also engaged in the same line of business as our company as on date of this Prospectus. For further details of our Promoter Group refer to Section titled “Our Promoter and Promoter Group” and “Our Group Companies” on page 139 and page 148 of this Prospectus.

We shall adopt the necessary procedures and practices as permitted by law to address any conflicting situations, as and when they may arise.

**Related business transaction within the Group and their significance on the financial performance of the company:**

For details relating to the business transactions within the Group Companies and their significance on the financial performance of the Company see the chapter titled “Financial Information of the Company – Annexure Q - Related Party Transactions” on page 185 of this Prospectus.

**Sales / Purchase between our Company and Group Companies:**

For details relating to sales or purchases between our Company and any of our Group Companies exceeding 10% of the sales or purchases of our Company see the chapter titled “Financial Information of the Company–Annexure Q- Related Party Transactions” on page 185 of this Prospectus.

**Business Interests amongst our Company and Group Companies /Associate Companies**

Except as mentioned under Related Party Transactions, “Annexure Q” beginning on page 185 under Chapter titled “Financial Information of the Company” there is no business interest among Group Company.

**Defunct /Struck-off Company**

None of Promoters, Promoter Group and our Group Companies has remained defunct and no application has been made to Registrar of Companies for Striking off their name from the Register of Companies, during the five years preceding the date of filing this prospectus.

**Changes in Accounting Policies in the last three years**

Except as mentioned under the paragraph Changes in Significant Accounting Policies, “Annexure IV” under Chapter titled “Financial Information of the Company” beginning on page 157 of the Prospectus, there have been no changes in the accounting policies in the last three years.

## **DIVIDEND POLICY**

Under the Companies Act, our Company can pay dividends upon a recommendation by our Board of Directors and approval by the shareholders at the general meeting of our Company. The Articles of Association of our Company give our shareholders, the right to decrease, and not to increase, the amount of dividend recommended by the Board of Directors.

The Articles of Association of our Company also gives the discretion to our Board of Directors to declare and pay interim dividends. No dividend shall be payable for any financial except out of profits of our Company for that year or that of any previous financial year or years, which shall be arrived at after providing for depreciation in accordance with the provisions of Companies Act, 2013.

Our Company does not have any formal dividend policy for declaration of dividend in respect of the Equity Shares. The declaration and payment of dividend will be recommended by our Board of Directors and approved by the shareholders of our Company at their discretion and may depend on a number of factors, including the results of operations, earnings, Company's future expansion plans, capital requirements and surplus, general financial condition, contractual restrictions, applicable Indian legal restrictions and other factors considered relevant by our Board of Directors.

Our Company has not declared any dividend on the Equity Shares in the past five financial years. Our Company's corporate actions pertaining to payment of dividends in the past are not to be taken as being indicative of the payment of dividends by our Company in the future.

**SECTION V – FINANCIAL INFORMATION OF THE COMPANY**

**RESTATED FINANCIAL STATEMENTS**

**Independent Auditors' Report**

**(As required by Section 26 of Companies Act, 2013 read with Rule 4 of Companies (Prospectus and Allotment of Securities) Rules, 2014)**

To,

**The Board of Directors,  
Krishana Phoschem Limited  
5-O-2, Basement Office,  
R.C Vyas Colony,  
Bhilwara - 311001,  
Rajasthan, India.**

Dear Sirs,

1. We have examined the attached Restated Financial Information of **M/s. Krishana Phoschem Limited** (hereinafter referred as “the Company”), which comprise of the Restated Summary Statement of Assets and Liabilities as at **November 30, 2016 and 31 March, 2016, 2015, 2014, 2013 and 2012**, The Restated Summary Statements of Profits and Loss and the Restated Summary Statement of Cash Flows for the **period ended on November 30, 2016 and each of the years ended March 31, 2016, 2015, 2014, 2013 and 2012** and the Summary of Significant Accounting Policies as approved by the Board of Directors of the Company prepared in terms of the requirements of :
  - a) Section 26 of Part I of Chapter III of the Companies Act, 2013 (“ the Act”), read with the applicable provisions within Rules 4 to 6 of Companies (Prospectus and Allotment of Securities) Rules, 2014 (“the Rules”);
  - b) The Securities and Exchange Board of India (Issue of Capital and Disclosure Requirements) Regulations, 2009 (“the Regulation”) (“SEBI ICDR Regulations”) as amended from time to time in pursuance of provisions of Securities and Exchange Board of India Act, 1992 (“ICDR Regulations”).

The preparation of the Restated Financial Information is the responsibility of the Management of the Company for the purpose set out in paragraph 8 below. The Management’s responsibility includes designing, implementing and maintaining adequate internal control relevant to the preparation and presentation of the Restated Standalone Financial Information. The Management is also responsible for identifying and ensuring that the Company complies with the Rules and ICDR Regulations.
2. We have examined such Restated Financial Information taking into consideration:
  - (a) The terms of reference to our engagements with the Company requesting us to examine financial statements referred to above and proposed to be included in the Draft Prospectus/ Prospectus being issued by the Company for its proposed Initial Public Offering of equity shares in SME Platform of NSE (“IPO” or “SME IPO”); and
  - (b) The Guidance Note on Reports in Company Prospectuses (Revised 2016) issued by ICAI (“The Guidance Note”).
3. These Restated Financial information of the Company have been compiled by the management from the Audited Financial Statements of the Company for the Stub Period ended on November 30, 2016 and financial year ended on March 31, 2016, March 31, 2015, March 31, 2014, March 31, 2013 & March 31, 2012, which have been approved by the Board of Directors.
4. The Statutory Audit of the Company are for the stub period ended on November 30, 2016 and financial year ended on March 31, 2016, 2015, 2014, 2013 & 2012 which have been conducted by **M/s Ashok Kanther & Associates, Chartered Accountants** and accordingly, reliance has been placed on the financial information examined by them. We have examined

the books of account underlying those financial statements and other records of the Company, to the extent considered necessary by us, for the presentation of the Restated Summary Statements under the requirements of Schedule III of the Act.

5. Based on our examination, we report that:
- a) The “**Restated Statement of Assets and Liabilities**” as set out in **Annexure I** to this report, of the Company for the Period ended as at November 30, 2016 and financial year ended as at March 31, 2016, March 31, 2015, March 31, 2014, March 31, 2013, and March 31, 2012 have been arrived at after making such adjustments and regroupings to the individual Financial Statements of the Company, as in our opinion were appropriate and more fully described in Significant Accounting Policies and Notes to the Restated Summary Statements as set out in **Annexure IV** to this Report.
  - b) The “**Restated Statement of Profit and Loss**” as set out in **Annexure II** to this report, of the Company for the Period ended as on November 30, 2016 and financial year ended on March 31, 2016, March 31, 2015, March 31, 2014, March 31, 2013 and March 31, 2012 have been arrived at after making such adjustments and regroupings to the individual financial statements of the Company, as in our opinion were appropriate and more fully described in Significant Accounting Policies and Notes to the Restated Summary Statements as set out in **Annexure IV** to this Report.
  - c) The “**Restated Statement of Cash Flow**” as set out in **Annexure III** to this report, of the Company for the Period ended as on November 30, 2016 and financial year ended on March 31, 2016, March 31, 2015, March 31, 2014, March 31, 2013 and March 31, 2012 have been arrived at after making such adjustments and regroupings to the individual financial statements of the Company, as in our opinion were appropriate and more fully described in Significant Accounting Policies and Notes to Restated Summary Statements as set out in **Annexure IV** to this Report.

Based on the above and also as per the reliance placed by us on the audited financial statements of the company and Auditors Report thereon which have been prepared by Statutory Auditor of the Company for the Period ended on November 30, 2016 & financial years ended on March 31, 2016, March 31, 2015, March 31, 2014, March 31, 2013 and March 31, 2012 we are of the opinion that “**Restated Financial Statements**” or “**Restated Summary Statements**” have been made after incorporating:

- (i) Adjustments for any material amounts in the respective financial years have been made to which they relate; and
  - (ii) There are no Extra-ordinary items except as shown in the Restated Profit & Loss Statement of that need to be disclosed separately in the Restated Summary Statements.
  - (iii) Adjustments on account of the statutory audit qualifications, if any, have been adjusted and regrouped to the individual financial statements of the Company, as in our opinion were appropriate and more fully described in Significant Accounting Policies and Notes to the Restated Summary Statements as set out in **Annexure IV** to this Report.
  - (iv) Adjustments in Financial Statements have been made in accordance with the correct accounting policies, which includes the impact of provision of gratuity made on actuarial valuation basis in the Restated Financial statements.
  - (v) There are revaluation reserves, which have been disclosed separately in the “**Restated Financial Statements**”.
  - (vi) The Company has not paid dividend on its equity shares during the reporting period.
6. In terms of Schedule VIII of the SEBI (ICDR) Regulations, 2009 and other provisions relating to accounts, We, **Mansaka Ravi & Associates**, Chartered Accountants, have been subjected to the peer review process of the Institute of Chartered Accountants of India (ICAI) and hold a valid **Certificate No. 008582 dated 23.12.2015** issued by the “Peer Review Board” of the ICAI.



## 7. Other Financial Information:

- a) We have also examined the following financial information as set out in annexure prepared by the Management and as approved by the Board of Directors of the Company for the Period ended on November 30, 2016, financial year ended on March 31, 2016, March 31, 2015, March 31, 2014, March 31, 2013 and March 31, 2012.

Restated Statement of Share Capital, Reserves And Surplus	Annexure-A
Restated Statement of Long Term And Short Term Borrowings	Annexure-B and B(A) & B(B)
Restated Statement of Deferred Tax (Assets) / Liabilities	Annexure-C
Restated Statement of Trade Payables	Annexure-D
Restated Statement of Other Current Liabilities And Short Term Provisions	Annexure-E
Restated Statement of Fixed Assets	Annexure-F
Restated Statement of Long-Term Loans And Advances	Annexure-G
Restated Statement of Inventories	Annexure-H
Restated Statement of Trade Receivables	Annexure-I
Restated Statement of Cash & Cash Equivalents	Annexure-J
Restated Statement of Short-Term Loans And Advances	Annexure-K
Restated Statement of Other Current Assets	Annexure-L
Restated Statement of Other Income	Annexure-M
Restated Statement of Turnover	Annexure-N
Restated Statement of Mandatory Accounting Ratios	Annexure-O
Restated Statement of Capitalization	Annexure-P
Restated Statement of Related Party Transaction	Annexure-Q
Restated Statement of Contingent Liabilities	Annexure-R
Restated Statement of Tax Shelter	Annexure-S

- b) The Restated Financial Information contain all the disclosures required by the SEBI ICDR regulations and partial disclosures as required by Accounting Standards notified under the Companies Act, 1956 of India read with the General Circular 15/ 2013 dated September 13, 2013 of the Ministry of Corporate Affairs in respect of Section 133 of the Companies Act, 2013.
- c) We have carried out Re-audit of the financial statements for the Year ended on March 31, 2016 and for the period ended on November 30, 2016 as required by SEBI regulations. We have not audited any financial statements of the Company as of any date or for any period subsequent to November 30, 2016. Accordingly, we do not express any opinion on the financial position, results or cash flows of the Company as of any date or for any period subsequent to November 30, 2016.
- d) The preparation and presentation of the Financial Statements referred to above are based on the Audited financial statements of the Company in accordance with the provisions of the Act and the Financial Information referred to above is the responsibility of the management of the Company.
- e) In our opinion, the above financial information contained in Annexure I to Annexure III and Annexure A to S of this report read along with the Restated Statement of Significant Accounting Policies and related Notes as set out in Annexure IV are prepared after making adjustments and regrouping as considered appropriate and have been prepared in accordance with Section 26 of the Act, read with the applicable provisions within Rule - 4 to 6 of Companies (Prospectus and Allotment of Securities) Rules, 2014, as amended, the SEBI Regulations, The Revised Guidance Note on Reports in Company Prospectuses and Guidance Note on Audit Reports/Certificates on Financial Information in Offer Documents issued by the Institute of Chartered Accountants of India (“ICAI”) to the extent applicable, as amended from time to time, and in terms of our engagement as agreed with you. We did not perform audit tests for the purpose of expressing an opinion on individual balances of account or summaries of selected transactions, and accordingly, we express no such opinion thereon.
- f) Consequently the financial information has been prepared after making such regroupings and retrospective adjustments as were, in our opinion, considered appropriate to comply with the same. As result of these regroupings and adjustments, the

amount reported in the financial information may not necessarily be same as those appearing in the respective audited financial statements for the relevant years.

- g) The report should not in any way be construed as a re-issuance or re-dating of any of the previous audit report, nor should this constructed as a new opinion on any of the financial statements referred to herein.
- h) We have no responsibility to update our report for events and circumstances occurring after the date of the report.
- i) Our report is intended solely for use of the management and for inclusion in the Offer Document in connection with the IPO-SME for Proposed Offer of Equity Shares of the Company and our report should not be used, referred to or distributed for any other purpose without our prior consent in writing.

**For Mansaka Ravi & Associates**  
**Chartered Accountants**  
**FRN: 015023C**  
**PRC No. 008582**

**Ravi Mansaka, FCA**  
**Partner**  
**M. No. 410816**

**Place: Jaipur**  
**Date: 26.12.2016**

**ANNEXURE -I****RESTATED STATEMENT OF ASSETS AND LIABILITIES**

(Amt in Lacs.)

Particulars	As at					
	11/30/2016	3/31/2016	3/31/2015	3/31/2014	3/31/2013	3/31/2012
<b>I. EQUITY AND LIABILITIES</b>						
<b>Shareholder's Funds</b>						
Share Capital	2,490.00	2,100.00	2,100.00	1,800.00	1,800.00	1,800.00
Reserves and Surplus (including Revaluation Reserves, if any)	6,229.52	5,395.25	5,215.36	4,757.00	2,284.23	1,890.74
Money received against share warrants	-	-	-	-	-	-
<b>Share Application Money Pending Allotment</b>	-	-	-	-	-	-
<b>Non Current Liabilities</b>						
Long-term Borrowings	1,508.79	1,261.76	1,276.81	1,264.36	1,812.47	1,506.70
Deferred tax liabilities (Net)	444.18	367.23	274.19	156.14	51.58	112.38
Other Long Term Liabilities	-	-	-	-	-	-
Long-term Provisions	-	-	-	-	-	-
<b>Current Liabilities</b>						
Short-term Borrowings	1,284.16	1,658.97	1,690.01	1,652.20	1,160.80	163.09
Trade Payables	722.53	318.27	1,227.61	1,042.30	681.32	212.05
Other Current Liabilities	197.41	344.27	293.44	410.13	187.89	169.74
Short-term Provisions	116.04	126.38	113.67	152.37	154.74	147.47
<b>Total</b>	<b>12,992.64</b>	<b>11,572.12</b>	<b>12,191.09</b>	<b>11,234.50</b>	<b>8,133.03</b>	<b>6,002.17</b>
<b>II. ASSETS</b>						
<b>Non Current Assets</b>						
Fixed assets						
(i) Tangible Assets	8,028.08	7,080.56	7,173.67	7,374.07	4,289.31	2,873.72
(ii) Intangible Assets	0.73	0.10	0.17	0.27	0.41	0.17
(iii) Capital Work-In-Progress	1,487.81	810.72	862.67	19.80	905.32	1,507.92
(iv) Intangible Assets Under Development	-	-	-	-	-	-
Non Current Investments	-	-	-	-	-	-
Deferred Tax Assets (Net)	-	-	-	-	-	-
Long-term Loans and Advances	61.06	58.67	101.19	145.85	172.24	40.72
Other Non Current Assets	-	-	-	-	-	-
<b>Current Assets</b>						
Current Investments	-	-	-	-	-	-
Inventories	2,220.88	1,527.86	3,109.40	3,248.98	1,851.60	486.89
Trade Receivables	640.18	1,499.72	480.82	196.66	573.38	796.40
Cash and Cash Equivalents	15.57	6.09	15.31	8.74	5.35	28.83
Short-term Loans and Advances	536.89	579.00	445.98	238.38	334.75	267.37
Other Current Assets	1.44	9.40	1.89	1.74	0.67	0.16
<b>Total</b>	<b>12,992.64</b>	<b>11,572.12</b>	<b>12,191.09</b>	<b>11,234.50</b>	<b>8,133.03</b>	<b>6,002.17</b>

Note:- The above statement should be read with the significant accounting policies and notes to restated summary, profits and losses and cash flows appearing in Annexure IV, II and III.

**ANNEXURE – II****RESTATED STATEMENT OF PROFIT AND LOSS**

(Amt in Lacs.)

Particulars		For the	For the Year ended				
		Period Ended	11/30/2016	3/31/2016	3/31/2015	3/31/2014	3/31/2013
Revenue from Operations		4,463.52	8,907.44	7,280.83	9,040.40	4,022.04	2,527.25
Other Incomes		56.12	155.23	444.99	43.30	165.16	166.03
<b>Total Revenue</b>	<b>A</b>	<b>4,519.64</b>	<b>9,062.67</b>	<b>7,725.82</b>	<b>9,083.70</b>	<b>4,187.20</b>	<b>2,693.28</b>
Expenses:							
Cost of Material Consumed		2,972.93	4,202.91	4,357.67	6,263.87	2,101.88	1,046.38
Employee Benefits Expenses		70.59	173.44	160.44	171.33	162.31	190.09
Administrative and other Expenses		1,019.28	1,831.59	2,245.12	2,045.86	1,709.39	911.01
Finance Costs		122.03	472.96	546.94	439.31	194.55	87.51
Depreciation And Amortization Expense		239.30	352.40	342.48	352.95	216.27	132.13
Changes in inventories		(487.78)	1,523.18	(444.09)	(944.93)	(954.38)	(185.19)
<b>Total Expenses</b>	<b>B</b>	<b>3,936.34</b>	<b>8,556.48</b>	<b>7,208.56</b>	<b>8,328.38</b>	<b>3,430.02</b>	<b>2,181.93</b>
Profit before exceptional and extraordinary items and tax (A-B)	<b>C</b>	583.30	506.19	517.26	755.32	757.18	511.35
Exceptional/Prior Period item		-	-	-	-	-	-
Profit before extraordinary items and tax		583.30	506.19	517.26	755.32	757.18	511.35
Extraordinary item		-	-	-	-	-	-
Profit Before Tax		<b>583.30</b>	<b>506.19</b>	<b>517.26</b>	<b>755.32</b>	<b>757.18</b>	<b>511.35</b>
Provision for Tax							
- Current Tax		115.42	107.34	101.69	150.18	149.56	146.49
- Deferred Tax Liability / (Asset)		76.96	93.04	118.04	104.56	(60.79)	13.76
MAT Credit Entitlement		-	-	-	-	-	-
Short/(Excess) Tax adjustment of prior years		(1.47)	(9.49)	4.74	(3.96)	32.58	7.23
<b>Restated profit after tax for the period from continuing operations</b>		<b>392.39</b>	<b>315.30</b>	<b>292.79</b>	<b>504.54</b>	<b>635.83</b>	<b>343.88</b>
Profit/ (Loss) from Discontinuing operation		-	-	-	-	-	-
Tax expenses of discontinuing operations		-	-	-	-	-	-
<b>Restated profit for the period</b>		<b>392.39</b>	<b>315.30</b>	<b>292.79</b>	<b>504.54</b>	<b>635.83</b>	<b>343.88</b>

Note: The above statement should be read with the significant accounting policies and notes to restated summary statements of assets and liabilities, and cash flows appearing in Annexure IV, I and III.

**ANNEXURE –III****RESTATED CASH FLOW STATEMENT**

(Amt in Lacs.)

Particulars	For the Period Ended	For the Year ended				
	11/30/2016	3/31/2016	3/31/2015	3/31/2014	3/31/2013	3/31/2012
<b>CASH FLOW FROM OPERATING ACTIVITIES</b>						
Net Profit before tax	583.30	506.19	517.26	755.32	757.18	511.35
Adjustment for :						
Less: Interest on Fixed Deposit	(1.60)	(6.18)	(11.07)	(18.34)	(6.27)	(1.65)
Less: Profit on Sale of Fixed Assets	0.73	0.10	-	2.88	0.01	0.29
Add: Depreciation	239.30	352.40	342.48	352.95	216.27	132.13
Add: Interest on Borrowed Fund & Finance Charges	122.03	472.96	546.94	439.31	194.55	87.51
<b>Operating profit before working capital changes</b>	<b>943.76</b>	<b>1,325.47</b>	<b>1,395.62</b>	<b>1,532.11</b>	<b>1,161.73</b>	<b>729.63</b>
Adjustment for :						
(Increase)/Decrease in Inventories	(693.01)	1,581.33	139.65	(1,397.27)	(1,364.69)	(325.75)
(Increase)/Decrease in Trade Receivables	859.54	(1,018.90)	(284.16)	376.72	223.02	(63.01)
(Increase)/Decrease in Short Term loans and advances	22.11	(155.02)	(255.60)	81.37	(57.38)	(78.62)
(Increase)/Decrease in Other Current Assets	-	-	-	-	-	-
(Increase)/Decrease in Long Term loans and advances	-	-	-	-	-	-
Increase/(Decrease) in trade payables	404.26	(909.34)	185.31	360.98	469.27	151.85
Increase/(Decrease) in Short Term Borrowings	(374.81)	(31.04)	37.81	491.40	997.71	(80.33)
Increase/(Decrease) in Short Term Provisions	(18.42)	7.05	9.79	(2.98)	4.20	0.69
Increase/(Decrease) in other current liabilities	(146.86)	50.83	(116.69)	222.24	18.15	8.83
	<b>52.81</b>	<b>(475.09)</b>	<b>(283.89)</b>	<b>132.45</b>	<b>290.28</b>	<b>(386.34)</b>
<b>Cash generated from / (used in) operations</b>	<b>996.57</b>	<b>850.39</b>	<b>1,111.73</b>	<b>1,664.57</b>	<b>1,452.01</b>	<b>343.28</b>
Income Tax paid/(refund)	77.91	77.51	107.13	131.77	189.60	138.33
<b>Net cash generated from/(used in) operating activities - (A)</b>	<b>918.66</b>	<b>772.88</b>	<b>1,004.60</b>	<b>1,532.79</b>	<b>1,262.41</b>	<b>204.95</b>
<b>CASH FLOW FROM INVESTING ACTIVITIES</b>						
Purchase of tangible fixed assets	(1,282.35)	(402.11)	(276.41)	(587.95)	(1,875.67)	(1,699.17)
(Increase)/Decrease in Capital Work-in-Progress	(677.09)	51.95	(842.87)	-	602.60	-
sale of fixed assets	9.55	7.38	-	1.23	1.22	0.90
(Increase)/Decrease in other Non-Current Assets	(2.39)	42.51	44.66	26.40	(131.52)	(6.34)
Interest Income on Fixed Deposit	1.60	6.18	11.07	18.34	6.27	1.65
Dividend Income	-	-	-	-	-	-
<b>Net cash (used in) Investing Activities - (B)</b>	<b>(1,950.68)</b>	<b>(294.09)</b>	<b>(1,063.54)</b>	<b>(541.98)</b>	<b>(1,397.11)</b>	<b>(1,702.96)</b>

<b>CASH FLOW FROM FINANCING ACTIVITIES</b>						
Proceeds from issue of Share Capital including share premium	916.50	-	600.00	-	-	600.00
Proceeds from Loan	247.03	(15.05)	12.45	(548.11)	305.77	1,161.64
Repayment of Long Term borrowings	-	-	-	-	-	-
Interest & Finance Charges	(122.03)	(472.96)	(546.94)	(439.31)	(194.55)	(87.51)
Dividend & DDT	-	-	-	-	-	-
Repayment of Share Application Money	-	-	-	-	-	(151.75)
<b>Net cash(used in) / from financing activities - (C)</b>	<b>1,041.50</b>	<b>(488.01)</b>	<b>65.51</b>	<b>(987.42)</b>	<b>111.22</b>	<b>1,522.38</b>
Net Increase/(decrease) in Cash & Cash Equivalents (A+B+C)	9.48	(9.22)	6.56	3.39	(23.48)	24.38
Cash and cash equivalents at the beginning of the year	6.09	15.31	8.74	5.35	28.83	4.45
Cash and cash equivalents at the end of the year	15.57	6.09	15.31	8.74	5.35	28.83
Cash and cash equivalents at the end of year comprises :						
1. Components of cash and cash equivalents:						
<b>Particulars</b>	<b>9/30/2016</b>	<b>3/31/2016</b>	<b>3/31/2015</b>	<b>3/31/2014</b>	<b>3/31/2013</b>	<b>3/31/2012</b>
Cash on hand	10.97	5.37	5.22	4.64	3.49	0.98
Balances with scheduled banks:						
In current accounts	4.60	0.72	10.09	4.10	1.86	27.85
Total Cash and cash equivalents	15.57	6.09	15.31	8.74	5.35	28.83

Notes:
1. The Cash Flow Statement has been prepared under indirect method as set out in Accounting Standard -3 on Cash Flow Statement, specified under the Companies Act, 1956 (which are deemed to be applicable as Section 133 of the Companies Act, 2013 ("the Act") read with Rule 7 of Companies (Accounts) Rules, 2014).
2. Figures in Brackets represents outflow.
3. The above statement should be read with the significant accounting policies and notes to restated summary statements of assets and liabilities, profits and losses as appearing in Annexures IV, I and II.

**ANNEXURE-IV****SIGNIFICANT ACCOUNTING POLICY AND NOTES TO THE RESTATED SUMMARY STATEMENTS****A. BACKGROUND**

The Company was originally incorporated on May 14, 2004 as “Krishana Phoschem Limited” vide Registration no. 17-019288/2004-2005 (CIN: U24124RJ2004PLC019288) under the provisions of the Companies Act, 1956 with the Registrar of Companies, Rajasthan, Jaipur.

The company is primarily engaged in manufacturing of fertilizers, intermediate dyes and other allied chemical products in the state of Madhya Pradesh. The company manufactures Benefited Rock Phosphate (BRP), Single Super Phosphate (SSP), Granulated Single Super Phosphate (GSSP), H-Acid, intermediate dyes and other allied chemicals. The products Single Super Phosphate (SSP) and Granulated Single Super Phosphate (GSSP) is used in replenishing “P” (Phosphorous) in the soil and act as a fertilizer for crop. Initially The Company was engaged in manufacturing of BRP and further expanded to forward integration in manufacturing of SSP and GSSP and expanding for Diversification in intermediate dyes and other allied chemicals. The manufacturing facilities are located near the Jhabua, Meghnagar District (M.P).

**B. STATEMENT OF SIGNIFICANT ACCOUNTING POLICIES****1. BASIS OF PREPARATION OF FINANCIAL STATEMENTS**

The Restated Summary Statement of Assets and Liabilities of the Company as on November 30, 2016, March 31, 2016, March 31, 2015, March 31, 2014, March 31, 2013 and March 31 2012 and the Restated Summary Statement of Profit and Loss and Restated Summary Statements of Cash Flows for the stub period ended on November 30, 2016 and financial year ended on March 31, 2016, March 31, 2015, March 31, 2014, March 31, 2013 and March 31 2012 and the annexure thereto (collectively, the “**Restated Financial Statements**” or “**Restated Summary Statements**”) have been extracted by the management from the Financial Statements of the Company for the stub period ended on November 30, 2016 and financial year ended March 31, 2016, March 31, 2015, March 31, 2014, March 31, 2013 and March 31 2012.

The financial statements are prepared and presented under the historical cost convention and evaluated on a going-concern basis using the accrual system of accounting in accordance with the accounting principles generally accepted in India (Indian GAAP) and the requirements of the Companies Act, 1956 (up to March 31, 2014), and notified sections, schedules and rules of the Companies Act 2013 (with effect from April 01, 2014), including the Accounting Standards as prescribed by the Companies (Accounting Standards) Rules, 2006 as per section 211(3C) of the Companies Act, 1956 (which are deemed to be applicable as Section 133 of the Companies Act, 2013 (“the Act”) read with Rule 7 of Companies (Accounts) Rules, 2014).

**2. USE OF ESTIMATES**

The preparation of financial statements in conformity with Generally Accepted Accounting Principles (GAAP) requires the management of the Company to make estimates and assumptions that affect the reported balances of assets and liabilities and disclosures relating to the contingent liabilities, if any, as at the date of the financial statements and reported amounts of income and expenses during the year. Examples of such estimates include provisions for doubtful debts, employee retirement benefit plans, provision for income tax and the useful lives of fixed assets. The difference between the actual results and estimates are recognized in the period in which results are known or materialized.

**3. FIXED ASSETS**

Fixed assets are stated at historical cost/revalued value (as valued by registered valuer) less accumulated depreciation and impairment losses, if any. Cost includes purchase price and all other attributable cost to bring the assets to its working condition for the intended use.

Subsequent expenditures related to an item of tangible asset are added to its book value only if they increase the future benefits from the existing asset beyond its previously assessed standard of performance.

Projects under which assets are not ready for their intended use are shown as Capital Work-in-Progress. Cost includes cost of land, materials, construction, services, borrowing costs and other overheads relating to projects.

Intangible assets are stated at acquisition cost, Net of accumulated amortization and accumulated impairment losses, if any. Intangible assets are amortized on a straight line basis over their estimated useful lives.

Gains or losses arising from the retirement or disposal proceeds and the carrying amount of the asset and recognized as income or expense in the Statement of Profit & Loss.

#### **4. DEPRECIATION**

##### **Tangible Fixed Assets**

In accordance with AS-6 “Depreciation”, depreciation on tangible fixed assets is computed on considering useful life provided in the Schedule - II of the Act. During the preceding years, the Company was providing depreciation on Straight Line Basis at the rate prescribed in Schedule XIV of the Companies Act, 1956.

The Company has provided depreciation on Plant and Machineries on the basis of their useful life on single shift used basis on BRP, DCP, SSP & GSSP plant, except extra shift depreciation has been provided on SSP & GSSP plant for the actual number of days for which the plant has been operated on double or triple shift basis in accordance with the provisions of Section 123 read with the Part C of Schedule II to the Companies Act, 2013. However, in respect of period upto 31.03.2014, triple shift depreciation charged on plant and machineries of all plants.

Pursuant to Companies Act, 2013 (‘the Act’) being effective from April 1, 2014, the Company has revised depreciation rates on tangible fixed assets as per useful life specified in Part ‘C’ of Schedule II of the Act. And due to the same there has been a change in the estimated useful life of depreciable tangible assets which affects the depreciation in the current period and in each period during the remaining useful life of the assets. As the change is only in regard to accounting estimate requiring an adjustment of the carrying amount of tangible assets. The same do not require adjustment in the financial information for the years ended on March 31, 2014, 2013, and 2012. The Company has consistently calculated depreciation based on Straight Line Method.

In respect of assets whose useful life had already exhausted as on 1 April 2014, Rs. 5.66 lakhs has been adjusted in Reserves and Surplus as on 31.03.2015 in accordance with requirements of Para 7 of Part C of Schedule II of the Act.

#### **5. BORROWING COSTS**

Borrowing cost includes interest and amortization of ancillary costs incurred in connection with the arrangement of borrowings. Borrowing costs directly attributable to the acquisition, construction or production of an asset that necessarily takes a substantial period of time to get ready for its intended use or sale are capitalized as part of the cost of the respective asset. All other borrowing costs are expensed in the period they occur.

#### **6. IMPAIRMENT OF ASSETS**

- (i) The company assesses, at each reporting date whether there is an indication that an asset may be impaired. If any indication exists, or when annual impairment testing for an asset is required, the company estimates the asset’s recoverable amount. An asset’s (including goodwill) recoverable amount is the higher of an assets net selling price and its value in use. The recoverable amount is determined for an individual asset, unless the asset does not generate cash inflows that are largely independent of those from other assets or groups of assets. Where the carrying amount of an asset exceeds its recoverable amount, the asset is considered impaired and is written down to its recoverable amount. In assessing the value in use, the estimated future cash flows are discounted to their present value using a pre-tax discount rate that reflects current market assessments of the time value of money and the risks specific to the asset. In determining net selling price, recent market transactions are taken into account, if available. If no such transactions can be identified, an appropriate valuation model is used.
- (ii) After impairment, depreciation/ amortization is provided on the revised carrying amount of the asset over its remaining useful life.



## 7. INVESTMENTS

Investments, which are readily realizable and intended to be held for not more than one year from the date on which such investments are made, are classified as current investments. All other investments are classified as long-term investments.

On initial recognition, all investments are measured at cost. The cost comprises purchase price and directly attributable acquisition charges such as brokerage, fees and duties.

Current investments are carried in the financial statements at lower of cost and fair value determined on an individual investment basis. Long-term investments are carried at cost. However, provision for diminution in value is made to recognize a decline other than temporary in the value of the investments.

On disposal of an investment, the difference between its carrying amount and net disposal proceeds is charged or credited to the statement of profit and loss.

## 8. INVENTORIES

### **Inventories are valued as under:**

- a) Raw Material: At lower of cost or net realizable value
- b) Finished goods: At lower of cost or net realizable value
- c) Stores & spares parts: At cost price

Cost of inventories comprise of all cost of purchase. Cost of conversion and other cost incurred in bringing them to their respective present location and condition.

## 9. REVENUE RECOGNITION

Revenue in respect of purchases/sale of product and scraps is recognized at the point of receipt/dispatch from parties at/from factory.

Income and expenditures are recognized on accrual basis. However, since it is not possible to ascertain with reasonable accuracy/ the quantum of accrual in respect of discount receivable/payable from/to parties, the same continue to be accounted for as and when received/settled.

## 10. PRICE CONCESSION FROM GOVERNMENT:

The price concession from Government on sale of single super phosphate & granular single super phosphate is recognized at the point of sale at the prevailing rates announced by the Government of India. Any shortfall in actual receipt or deduction made by the Government is written off as an expense in the year in which the same is determined. The Company treats the price concession as part of the sale proceeds.

## 11. FOREIGN CURRENCY TRANSACTIONS

Transaction denominated in foreign currencies are normally recorded at the exchange rate prevailing at the time of the transaction and any income or expenses on account of exchange difference either on settlement or on translation is recognized in the Statement of profit and Loss except in case where they relate to acquisition of fixed assets, are adjusted with the carrying cost of such assets.

## 12. EMPLOYEE BENEFITS

### **Defined-contribution plans:**

A defined contribution plan is a post-employment benefit plan under which the company pays specified contributions to a separate entity. The Company makes specified monthly contributions towards Provident Fund. The Company's contributions to Employees Provident Fund are charged to statement of profit and loss every year.

(ii) The company has no policy of encashment and accumulation of Leave. Therefore, no provision of Leave Encashment is being made.

(iii) Employee Gratuity Fund Scheme is the Defined Benefit Plan. Provision for gratuity has been made in the accounts, in case of those employees who are eligible for the retirement benefits. Gratuity is paid at the time of retirement of employees. Provision for gratuity liability is provided based on valuation performed by Life Insurance Corporation of India.

(iv) Short Term Employee Benefits like leave benefit, if any, are paid along with salary and wages on a month to month basis, bonus to employees are charged to profit and loss account on the basis of actual payment on year to year basis.

### **13. ACCOUNTING FOR TAXES ON INCOME**

Tax expense comprises of current and deferred tax. Current income tax is measured at the amount expected to be paid to the tax authorities in accordance with the Income-tax Act, 1961 enacted in India. The tax rates and tax laws used to compute the amount that are enacted or substantively enacted, at the reporting date.

(i) Deferred income taxes reflect the impact of timing differences between taxable income and accounting income originating during the current year and reversal of timing differences for the earlier years. Deferred tax is measured using the tax rates and the tax laws enacted or substantively enacted at the reporting date.

(ii) Deferred tax liabilities are recognized for all taxable timing differences. Deferred tax assets are recognized for deductible timing differences only to the extent that there is reasonable certainty that sufficient future taxable income will be available against which such deferred tax assets can be realized. In situations where the Company has unabsorbed depreciation or carry forward tax losses, all deferred tax assets are recognized only if there is virtual certainty supported by convincing evidence that they can be realized against future taxable profits.

The carrying amount of deferred tax assets are reviewed at each reporting date. The company writes-down the carrying amount of a deferred tax asset to the extent that it is no longer reasonably certain or virtually certain, as the case may be, that sufficient future taxable income will be available against which deferred tax asset can be realized. Any such write-down is reversed to the extent that it becomes reasonably certain or virtually certain, as the case may be, that sufficient future taxable income will be available.

### **14. CONTINGENT LIABILITIES AND PROVISIONS**

Provisions are recognized only when there is a present obligation as a result of past events and when a reliable estimate of the amount of obligation can be made.

Contingent Liability is disclosed for

- a) Possible obligation which will be confirmed only by future events not wholly within the control of the Company or
- b) Present obligations arising from the past events where it is not probable that an outflow of resources will be required to settle the obligation or a reliable estimate of the amount of the obligation cannot be made.
- c) Contingent Assets are not recognized in the financial statements since this may result in the recognition of income that may never be realized.

A disclosure for a contingent liability is made when there is a possible obligation or a present obligation that may, but probably will not, require an outflow of resources. Where there is a possible obligation or a present obligation that the likelihood of outflow of resources is remote, no provision or disclosure is made.

### **15. EARNINGS PER SHARE:**

In determining the Earnings Per share, the company considers the net profit after tax which does not include any post tax effect of any extraordinary / exceptional item. The number of shares used in computing basic earnings per share is the weighted average number of shares outstanding during the period.

The number of shares used in computing Diluted earnings per share comprises the weighted average number of shares considered for computing Basic Earnings per share and also the weighted number of equity shares that would have been issued on conversion of all potentially dilutive shares.

In the event of issue of bonus shares, or share split the number of equity shares outstanding is increased without an increase in the resources. The number of Equity shares outstanding before the event is adjusted for the proportionate change in the number of equity shares outstanding as if the event had occurred at the beginning of the earliest period reported.

## **16. CASH FLOW:**

Cash flows are reported using the indirect method, whereby profit before tax is adjusted for the effects of transactions of non-cash nature, any deferrals or accruals of past or future operating cash receipts or payments and item of income or expenses associated with investing or financing cash flows. Cash flows from operating, investing and financing activities of the Company are segregated, accordingly.

## **17. SEGMENT REPORTING:**

### **(i) Business Segment**

(a) The business segment has been considered as the primary segment.

(b) The Company's primary business segments are reflected based on principal business activities, the nature of service, the differing risks and returns, the organization structure and the internal financial reporting system.

(c) The Company's primary business comprises of manufacturing of fertilizers, intermediate dyes and other allied chemical products and since it is the only reportable segment as envisaged in Accounting Standard 17 'Segment Reporting'. Accordingly, no separate disclosure for Segment reporting is required to be made in the financial statements of the Company.

### **(ii) Geographical Segment**

The Company operates in one Geographical Segment namely "within India" and hence no separate information for geographic segment wise disclosure is required.

## **C. CHANGES IN ACCOUNTING POLICIES IN THE PERIODS/YEARS COVERED IN THE RESTATED FINANCIALS**

There is change in significant accounting policies adopted by the Company, the details of which are as under:

- 1) The Company has not been following the provisions of Accounting Standard – 15 "Employee Benefits" issued by the Institute of Chartered Accountants of India for provision for Gratuity and accordingly, the provision of gratuity has not been accounted for by the management in books of account. The Company was charging contributions to employees benefits plans in the form Gratuity to profit and loss account of the year when the contributions are due as per LIC Gratuity Fund.

## **D. NOTES ON RESTATEMENTS MADE IN THE RESTATED FINANCIALS**

1. The financial statements including financial information have been prepared after making such regroupings and adjustments, considered appropriate to comply with the same. As result of these regroupings and adjustments, the amount reported in the financial statements/information may not necessarily be same as those appearing in the respective audited financial statements for the relevant years.
2. The Company does not have information as to which of its supplier are Micro small and Medium Enterprise registered under The Micro small and Medium Enterprise Development Act 2006. Consequently the liability, if any, of interest which would be payable under The Micro small and Medium Enterprise Development Act 2006, cannot be ascertained. However, the Company has not received any claims in respect of such interest and as such, no provision has been made in the books of accounts.

**3. Employee benefits:**

The Company has adopted the Accounting Standard 15 (revised 2005) on Employee Benefits as per an actuarial valuation in restated financials though such valuation is carried out by Life Insurance Corporation of India. The disclosures as envisaged under the standard are as under:-

(Rs. In Lakhs)

Particulars	30.11.2016	2015-16	2014-15	2013-14	2012-13	2011-12
<b>1. Reconciliation of opening and closing balances of defined benefit obligation</b>						
a) At the beginning of the year	14.71	22.81	20.79	16.67	12.78	9.84
b) Current Service Cost	1.27	3.62	3.95	3.86	3.14	2.83
c) Interest Cost	.69	1.82	1.66	1.33	1.02	.79
d) Actuarial (Gain) Loss	(6.13)	2.79	(3.59)	(.57)	(.27)	(.68)
e) Benefits Paid	0	(16.33)	0	(.51)	0	0
f) Defined Benefits Obligation at year end	10.54	14.71	22.81	20.79	16.67	<b>12.78</b>
<b>2. Reconciliation of opening and closing balances of fair value of plan assets</b>						
a) At beginning of the year	14.07	28.37	25.32	22.09	17.17	13.56
b) Expected Return on plan assets	0.00	2.04	3.62	2.03	1.60	1.27
c) Actuarial Gain / (Loss)	0.00	0.00	0.00	0.00	0.00	0.00
d) Employer Contributions	0.00	0.00	(.58)	1.72	3.32	2.33
e) Benefits paid	0.00	(16.33)	0.00	(.51)	0.00	0.00
f) Fair Value of the plan assets at the year end	14.07	14.07	28.37	25.32	22.09	17.17
<b>3. Reconciliation of fair value of obligation and Assets</b>						
a) Present value of obligation as at year end	10.54	14.71	22.81	20.79	16.67	12.78
b) Fair value of plan assets as at year end	14.07	14.07	28.37	25.32	22.09	17.17
c) Amount recognized in Balance Sheet (a-b)	(3.53)	.64	(5.56)	(4.54)	(5.41)	(4.39)
<b>4. Expense recognized during the year</b>						
a) Current Service Cost	1.27	3.62	3.95	3.86	3.14	2.83
b) Interest Cost	0.69	1.82	1.66	1.33	1.02	0.79
c) Actuarial (gain) / loss	(6.13)	2.79	(3.59)	(.57)	(.27)	(.68)
d) Expected return on plan assets	0	(2.04)	(3.62)	(2.03)	(1.60)	(1.27)
e) Net Cost (a+b+c+d)	(4.17)	6.20	(1.60)	2.60	2.29	1.67
<b>5. Investment Details of Plan Assets</b>						
Name of retirement benefit	Name of Trust		Policy No.		Investment with	
Gratuity	KRISHNA PHOCHEM LTD., Employees Group Gratuity Trust		G.G. TRU 101000392 (Old No. 325348)		LIC of India	
<b>6. There are no amount included in the fair value of plan assets for</b>						
i) Company's own financial instruments.						
ii) Property occupied by or other assets used by the Company.						
<b>7. Principal Actuarial Assumptions at the Balance Sheet date</b>						
Discount Rate	7% per annum	8% per annum	8% per annum	8% per annum	8% per annum	8% per annum
Expected Rate of return on plan assets	-	8% per annum	8% per annum	8% per annum	8% per annum	8% per annum
Future Salary Increase	5% per annum	7% per annum	7% per annum	8% per annum	8% per annum	8% per annum
8. The overall expected rate of return on assets is assumed based on the market prices prevailing on that date over the accounting period. The Company is having approved gratuity trust and leave encashment policy, which is having insurer Managed Fund.						
<b>9. Experience Adjustment:</b>						
Defined Benefits Obligation	10.54	14.71	22.81	20.79	16.67	12.78
Plan assets	14.07	14.07	28.37	25.32	22.09	1.72

Surplus/(deficit)	(6.13)	(.64)	5.56	4.54	5.41	4.39
Experience adjustment on plan Liabilities (loss)/ gain	(6.13)	2.79	(3.59)	(.57)	(.27)	(.68)
Experience adjustment on plan Assets (loss)/ gain	0.00	0.00	0.00	0.00	0.00	0.00

As informed to us, Company does not have any earned leave balance as on year ends.

#### 4. Segment Reporting (AS 17)

The Company is required to disclose the information required by Accounting Standard- 17. No separate segments have, however, been reported as the company does not have more than one business Segment within the meaning of Accounting standard -17, which differ from each other in risk and reward.

#### 5. Change in Accounting Estimate

In Restated financials the Company has calculated the depreciation based on the rates given in Schedule XIV of the Companies Act, 1956 till 31.03.2014 and after 31.03.2014 based on the rates given in Schedule II of the Companies Act, 2013. In respect of assets whose useful life had already exhausted as on 1 April 2015, has been adjusted in Reserves and Surplus in accordance with requirements of Para 7 of Part C of Schedule II of the Act. Such assets which do not have useful life as on 01.04.2015 were having WDV Rs. 5.66 lakhs.

#### 6. Provisions, Contingent Liabilities and Contingent Assets (AS 29)

Contingent liabilities and commitments (to the extent not provided for). There are no contingent liabilities as on March 31, 2016 except as mentioned in Annexure -V, for any of the years covered by the statements.

#### 7. Related Party Disclosure (AS 18)

Related party transactions are reported as per AS-18 of Companies (Accounting Standards) Rules, 2006, as amended, in the Annexure – Q of the enclosed financial statements.

#### 8. Accounting For Taxes on Income (AS 22)

Deferred Tax liability/Asset in view of Accounting Standard – 22: “Accounting for Taxes on Income” as at the end of the year/period is reported as under

Particulars	(Amount in Rs.)					
	As At					
Deferred Tax Liability	11/30/2016	3/31/2016	3/31/2015	3/31/2014	3/31/2013	3/31/2012
Net WDV as Per Companies Act	6,564.72	5,531.94	5,489.71	5,561.45	3,268.59	1,610.41
Net WDV As per Income Tax Act	3,556.96	2,190.69	2,074.00	2,150.40	1,079.84	1,258.54
<b>Timing Difference Due to Depreciation</b>	<b>3,007.75</b>	<b>3,341.25</b>	<b>3,415.71</b>	<b>3,411.05</b>	<b>2,188.75</b>	<b>351.87</b>
<b>Deferred Tax Liability (A)</b>	<b>929.40</b>	<b>1,032.45</b>	<b>1,055.45</b>	<b>1,054.01</b>	<b>676.32</b>	<b>114.16</b>
Incremental Due to Depreciation	(103.05)	(23.01)	1.44	377.69	562.16	15.54
Gratuity Expenses Disallowed	(4.17)	6.20	(1.60)	2.60	2.29	1.67
Disallowance u/s 43B	-	10.17	-	4.24	4.82	3.84
Unabsorbed Losses of Specified Business	1,574.44	2,136.45	2,529.97	2,898.90	2,014.70	-
<b>Timing Difference Due to Gratuity/Disallowances/Losses</b>	<b>1,570.26</b>	<b>2,152.82</b>	<b>2,528.38</b>	<b>2,905.73</b>	<b>2,021.81</b>	<b>5.51</b>
<b>Deferred Tax Assets (B)</b>	<b>485.21</b>	<b>665.22</b>	<b>781.27</b>	<b>897.87</b>	<b>624.74</b>	<b>1.79</b>

Incremental Due to Unabsorbed Depreciation/Gratuity/Exp	(180.01)	(116.05)	(116.60)	273.13	622.95	1.79
Net of Deferred Tax Liability/(Deferred Tax Assets) (A-B)	444.18	367.23	274.19	156.14	51.58	112.38
Opening Deferred Tax Liability / (Asset)	367.23	274.19	156.14	51.58	112.38	98.62
Debited/(Credit) to Restated Statement of Profit and Loss Account	<b>76.96</b>	<b>93.04</b>	<b>118.04</b>	<b>104.56</b>	<b>(60.79)</b>	<b>13.76</b>

## 9. Earnings Per Share (AS 20):

Earnings per Share have been calculated is already reported in the Annexure – O of the enclosed financial statements.

## 10. MATERIAL ADJUSTMENTS [AS PER SEBI (ICDR) REGULATIONS, 2009]

Appropriate adjustments have been made in the restated financial statements, whenever required, by reclassification of the corresponding items of assets, liabilities and cash flow statement, in order to ensure consistency and compliance with requirement of Company Act 1956, and as replaced by Company Act 2013 after 01<sup>st</sup> April 2014 and Accounting Standards.

The Summary of results of restatements made in the audited financial statements of the Company for the respective period / years and their impact on the profit / (loss) and assets and liabilities of the Company is as under.

### Statement of adjustments in the Financial Statements

The reconciliation of Profit after tax as per audited results and the Profit after tax as per Restated Accounts is presented below in Table-1. This summarizes the results of restatements made in the audited accounts for the respective years/ period and its impact on the profit & loss of the company.

#### 1. Statement of Profit and Loss after Tax - Table -1

Particulars	For the Period 01.04.2016 to 30.11.2016	2015-16	2014-15	2013-14	2012-13	2011-12
<b>Net Profit After Tax as per audited accounts but before adjustments for restated accounts:</b>	221.26	138.26	98.18	717.63	730.14	380.69
Decrease/(Increase) in Loss on sale of Fixed Assets	(0.24)	1.50	-	0.03	0.00	0.12
Decrease/(Increase) in Other Expenses - TDS Defaults as per 26AS	-	-	(0.05)	-	(0.00)	(0.57)
Decrease/(Increase) in Depreciation as per Companies Act	150.68	203.92	247.58	6.41	4.66	5.10
Decrease/(Increase) Provision for Gratuity	4.17	(6.20)	1.01	(0.88)	1.03	0.66
(Decrease)/Increase in Prior Period - Adjustment	10.71	0.66	(10.30)	(1.07)	-	-
Decrease/(Increase) of expenses due to Capitalisation of Exp	0.54	0.84	0.18	0.19	0.50	0.30
Decrease/(Increase) on Preoperative Expenses	-	-	-	-	-	1.68
Decrease/(Increase) in DTL	5.27	(23.67)	(43.81)	(217.78)	(100.50)	(44.09)
<b>Net Increase/ (Decrease)</b>	171.13	177.05	194.62	(213.10)	(94.31)	(36.79)
<b>Profits after Tax as per Restated Accounts</b>	392.39	315.31	292.80	504.53	635.83	343.88

**a) Adjustment on account of provision for Gratuity:**

The Company did not provide gratuity based on the requirement of AS -15 (Revised), therefore during the restatement, provision for gratuity have been done as per the actuarial valuation performed by Life Insurance Corporation of India and accordingly short/excess provisions in respective year were adjusted to comply with the requirement of AS-15 (Revised). Further, an adjustment of Rs. 3.72 lakhs has also been carried out by reducing the opening balances of retained earnings, to give effect the valuation reports of Gratuity as provided by LIC.

**b) Accounting of Depreciation (AS -6)**

During the process of restatement of Accounts, Company has rectified the Depreciation provision which was wrong on account of arithmetical errors and wrong rate of depreciation adopted, wrong accounting of revaluation reserve and non Compliance with the requirement of schedule II of the Companies Act, 2013 w.e.f. 1.4.2014 onwards. The same has been rectified and accordingly effect thereof has been stated in Table 1 (Statement of Profit and Loss after Tax).

**c) Adjustment on account of Provision of Deferred Tax:**

Due to changes in Depreciation and Provision for Gratuity, etc, the Company has recalculated the deferred tax liability and deferred tax assets at the rate of normal Tax rate applicable at the end of relevant year.

**d) Adjustment on account of Tax Provision and MAT Credit Entitlement and Set-off thereof**

Due to changes in accounting policies and other adjustments as stated above, the Company has recalculated the Income-tax provision and MAT Credit Entitlement and Set-off thereof at the rate of normal Tax rate applicable at the end of relevant year and accordingly, their readjusted amounts have been provided in Tax Shelter, Annexure - S.

**e) Accounting of Excess Depreciation prior to 31.03.2011:**

During the period of restatement, the Company has identified excess depreciation charged upto 31.03.2011 and accordingly has transferred Rs. 22.02 lakhs in Opening balance of Retained earnings and adjusted the carrying amount of fixed Assets and deferred tax as on 01.04.2011.

**f) Adjustment on account of accounting of Pre-operative expenses and Preliminary Expenses**

During the period of restatement, the Company has identified the wrong practice of charging pre-operative and preliminary expense on deferred basis and accordingly, the remaining balance of such expenses as on 31<sup>st</sup> March, 2011 (amounting to Rs. 1.68 lakhs) has been adjusted through opening balances of retained earnings as on 1<sup>st</sup> April, 2011.

**g) Adjustment on account of wrong accounting of revaluation reserve**

During the period of restatement, the Company has identified the wrong accounting practice of revaluation reserve for the FY 2014-15, FY 2015-16 and for the period ended on 30 November, 2016. In these periods, the Company was charging depreciation on whole value of fixed assets including revaluation in profits and loss account and the part of revaluation reserve to the extent of depreciation on account of revaluation has been directly reduced from the retained earning instead of routing it through profit and loss account. Accordingly, the Company has rectified that accounting practice during the course of restatement. The impact of such rectification is as under:

Financial Year/Period	Revaluation Reserve not credited to profit and loss account	Profits increased by
FY 2014-15	128.76 lakhs	128.76 lakhs
FY 2015-16	127.72 lakhs	127.72 lakhs
Period from 01.04.2016 to 30.11.2016	84.62 lakhs	84.62 lakhs

**11. Realizations:**

In the opinion of the Board and to the best of its knowledge and belief, the value on realization of current assets, loans and advances will, in the ordinary course of business. These of business, not be less than the amounts at which they are stated in the Balance sheet.

**12. Contractual liabilities**

All other contractual liabilities connected with business operations of the Company have been appropriately provided for.

**13. Amounts in the financial statements**

Amounts in the financial statements are rounded off to nearest lakhs. Figures in brackets indicate negative values.

**For Mansaka Ravi & Associates**  
**Chartered Accountants**  
**FRN 015023C**  
**PRC No. 008582**

**Ravi Mansaka, FCA**  
**Partner**  
**Membership No. 410816**

**Date: 26.12.2016**  
**Place: Jaipur**



**ANNEXURE-A****RESTATED STATEMENT OF SHARE CAPITAL, RESERVES AND SURPLUS**

(Amt in Lacs.)

Particulars	As at					
	11/30/2016	3/31/2016	3/31/2015	3/31/2014	3/31/2013	3/31/2012
<b>Share Capital</b>						
<b>Authorised Share Capital</b>	2,500.00	2,500.00	2,500.00	2,000.00	2,000.00	2,000.00
Equity shares of Rs.10 each						
Share Capital						
Issued, Subscribed and Paid up Share Capital	2,490.00	2,100.00	2,100.00	1,800.00	1,800.00	1,800.00
Equity Shares of Rs. 10 each fully paid up						
Share Capital (in Rs.)						
<b>Total</b>	<b>2,490.00</b>	<b>2,100.00</b>	<b>2,100.00</b>	<b>1,800.00</b>	<b>1,800.00</b>	<b>1,800.00</b>
Reserves and Surplus						
A) Revaluation Reserve	3,032.29	3,167.71	3,296.48	1,328.25	1,570.59	1,812.94
Add: Addition during the year	-	-	-	2,211.19	-	-
Less: Deduction During the Year	-	(7.70)	-	-	-	-
Less: Current Year depreciation on revaluation transfer to General Reserve	(84.62)	(127.72)	(128.77)	(242.96)	(242.34)	(242.34)
<b>Total (A)</b>	<b>2,947.67</b>	<b>3,032.29</b>	<b>3,167.71</b>	<b>3,296.48</b>	<b>1,328.25</b>	<b>1,570.59</b>
B) Security Premium						
Opening Balance	300.00	300.00	-	-	-	-
Add: Addition during the year	526.50	-	300.00			
Less: Utilised During the Year	-	-	-	-	-	-
<b>Total (B)</b>	<b>826.50</b>	<b>300.00</b>	<b>300.00</b>	<b>-</b>	<b>-</b>	<b>-</b>
C) Surplus in Profit and Loss account						
Opening Balance	2,062.96	1,747.65	1,460.52	955.98	320.15	576.28
Add: Profit for the year	392.39	315.30	292.79	504.54	635.83	343.88
Add: Transfer from revaluation reserve	-	-	-	-	-	-
Less: Additional Depreciation on account change in Depreciation rates as per companies Act 2013	-	-	(5.66)	-	-	-
Less: Bonus Issue	-	-	-	-	-	(600.00)
<b>Total (C)</b>	<b>2,455.34</b>	<b>2,062.96</b>	<b>1,747.65</b>	<b>1,460.52</b>	<b>955.98</b>	<b>320.15</b>
<b>Total (A+B+C)</b>	<b>6,229.52</b>	<b>5,395.25</b>	<b>5,215.36</b>	<b>4,757.00</b>	<b>2,284.23</b>	<b>1,890.74</b>
1. Terms/rights attached to equity shares:						
i. The company has only one class of shares referred to as equity shares having a par value of Rs.10/-. Each holder of equity shares is entitled to one vote per share.						

- ii. In the event of liquidation of the Company, the holders of equity shares shall be entitled to receive any of the remaining assets of the Company, after distribution of all preferential amounts. The amount distributed will be in proportion to the number of equity shares held by the shareholders.
2. The figures disclosed above are based on the restated summary statement of assets and liabilities of the Company.
3. Company is having Revaluation Reserve as discussed above.
4. The above statement should be read with the significant accounting policies and notes to restated summary statements of assets and liabilities, profits and losses and cash flows appearing in Annexures IV, I, II and III.
5. The reconciliation of the number of shares outstanding as at: -

Particulars	As at ( No of Shares)					
	11/30/2016	3/31/2016	3/31/2015	3/31/2014	3/31/2013	3/31/2012
Number of shares at the beginning	21,000,000.00	21,000,000.00	18,000,000.00	18,000,000.00	18,000,000.00	6,000,000.00
Add: Shares Issued During the Year	3,900,000.00	-	3,000,000.00	-	-	12,000,000.00
Less: Shares bought back during the Year	-	-	-	-	-	-
Number of shares at the end	<b>24,900,000.00</b>	<b>21,000,000.00</b>	<b>21,000,000.00</b>	<b>18,000,000.00</b>	<b>18,000,000.00</b>	<b>18,000,000.00</b>

6. The detail of shareholders holding more than 5% of Shares as at: -

Name of Share Holder	As at ( No of Shares)					
	11/30/2016	3/31/2016	3/31/2015	3/31/2014	3/31/2013	3/31/2012
Madya Bharat Agro Products Ltd	1,785,000.00	1,785,000.00	1,785,000.00	1,785,000.00	1,845,000.00	1,845,000.00
Vesta Tex Pvt Ltd	-	-	-	963,750.00	963,750.00	963,750.00
Archid Products Pvt Ltd	1,771,500.00	1,771,500.00	1,771,500.00	1,771,500.00	1,771,500.00	1,771,500.00
Chunri Print Pvt Ltd	-	-	-	919,500.00	919,500.00	919,500.00
Swatik Clothex Pvt Ltd	1,440,000.00	1,440,000.00	1,440,000.00	1,440,000.00	1,440,000.00	1,440,000.00
Seasons Agro Chem India Pvt Ltd	2,387,500.00	2,387,500.00	2,387,500.00	3,557,500.00	-	-
Ostwal Phoschem India Ltd	9,766,500.00	4,966,500.00	4,201,500.00	-	-	-

### ANNEXURE – B

#### RESTATED STATEMENT OF LONG TERM AND SHORT TERM BORROWINGS

(Amt in Lacs.)

Particulars	As at					
	11/30/2016	3/31/2016	3/31/2015	3/31/2014	3/31/2013	3/31/2012
Long Term Borrowings						
From Banks/Financial Institutions (Secured)						
Term Loans	1,003.40	828.87	830.92	1,043.77	1,086.93	895.05
Loans and Advances (Unsecured)						
From Promoters/Directors/Related Parties	505.39	432.89	445.89	220.59	725.54	611.65
From others	-	-	-	-	-	-
<b>Total</b>	<b>1,508.79</b>	<b>1,261.76</b>	<b>1,276.81</b>	<b>1,264.36</b>	<b>1,812.47</b>	<b>1,506.70</b>
<b>Current portion of long-term borrowings, included under Other current liabilities</b>						

Term Loans and Car Loans	-	-	-	-	-	-
<b>Short Term Borrowings</b>						
From Banks (Secured)	-	-	-	-	-	-
Bank Working Capital Loan/OD/CC/BC	1,284.16	1,658.97	1,690.01	1,652.20	1,160.80	163.09
Others	-	-	-	-	-	-
Loan from Promoters/Directors/Related Parties	-	-	-	-	-	-
<b>Total</b>	<b>1,284.16</b>	<b>1,658.97</b>	<b>1,690.01</b>	<b>1,652.20</b>	<b>1,160.80</b>	<b>163.09</b>
The above amount includes:						
Secured Borrowings	<b>2,287.56</b>	<b>2,487.84</b>	<b>2,520.93</b>	<b>2,695.97</b>	<b>2,247.73</b>	<b>1,058.14</b>
Unsecured Borrowings	<b>505.39</b>	<b>432.89</b>	<b>445.89</b>	<b>220.59</b>	<b>725.54</b>	<b>611.65</b>

**Notes:**

- The figures disclosed above are based on the restated summary statement of assets and liabilities of the Company.
- The above statement should be read with the significant accounting policies and notes to restated summary, statements of assets and liabilities, profits and losses and cash flows appearing in Annexure IV, I, II and III.
- List of persons/entities classified as 'Promoters' and 'Promoter Group Companies' has been determined by the Management and relied upon by the Auditors. The Auditors have not performed any procedure to determine whether the list is accurate and complete.
- The terms and conditions and other information in respect of Secured Loans as on 31.03.2016 and 30.11.2016 are given in Annexure -B (A)
- The terms and conditions and other information in respect of Unsecured Loans as on 31.03.2016 and 30.11.2016 are given in Annexure (B)

**ANNEXURE B (A)**
**RESTATED STATEMENT OF LONG TERM AND SHORT TERM BORROWINGS**
**(Amt in Lacs.)**

Name of Lender	Purpose	Loan\ Agreement A/c No.	Sanctioned Amount (In Lacs)	Rate of interest	Primary Security	Collateral/Other Security	Re-Payment Schedule	Moratorium	Outstanding amount as on 30.11.2016 as per Books	Outstanding amount as on 31.03.2016 as per Books
<b>Secured Loan</b>										
HDFC Bank	Cash Credit	50200007423685	1,700.00	11.30%	Hypothecation by way of first and exclusive charge on all present and future Stocks & Books Debts	1. Factory Land & Building Situated at Plot No. 115, 116, 117, 118-A, 118-B, 119, 120, 126 to 133, 142, 143 Megh Nagar, Jhabua, M.P. -457661	Monthly	-	1,164.13	1,658.97
HDFC Bank	Buyers Credit	82172787	122.00	11.40%		2. Plot At A-07 (Araji No	Monthly	-	120.03	-
HDFC Bank	Working Capital Term Loan	81227843	252.01	11.30%			Monthly	-	103.97	159.18
HDFC Bank	Working Capital Term	81236098	871.76	11.30%			Monthly	-	545.80	667.88

	Loan					189), Kumud Vihar Yojana, Akola-Bhilwara - 311607				
HDF C Bank	Working Capital Term Loan	81882517	519.11	11.30%		3. Plot No. 126A & 134, Megh Nagar, Jhabua, M.P.-457779	Monthly	-	504.55	300.00
<b>Total</b>			<b>3,464.88</b>						<b>2,438.49</b>	<b>2,786.03</b>

**ANNEXURE – B (B)**

**RESTATED STATEMENT OF TERMS & CONDITIONS OF UNSECURED LOANS**

A) Details of Unsecured Loans outstanding as at the end of the latest Reporting period from Directors/Promoters/Group Companies and other Companies

Unsecured Loans from Directors/Promoters/Group Companies and other Companies are interest free and all are taken without any preconditions attached towards repayments.

Name of Lender	Purpose	Rate of interest	Re-Payment Schedule	Moratorium	Outstanding Amount As On (as per Books)	
					31.03.2016	30.11.2016
Alovera Tradelink Pvt Ltd	Business Loan	Nil	On Demand	Nil	22.35	40.35
Archid Product Pvt Ltd	Business Loan	Nil	On Demand	Nil	48.83	48.83
Chunri Prints Pvt Ltd	Business Loan	Nil	On Demand	Nil	56.00	56.00
Destiny Exim Pvt Ltd	Business Loan	Nil	On Demand	Nil	10.85	38.35
Dove Creation Pvt Ltd	Business Loan	Nil	On Demand	Nil	34.76	34.76
Duggal Tax Pvt Ltd	Business Loan	Nil	On Demand	Nil	39.95	39.95
Kolaveri Textile Pvt Ltd	Business Loan	Nil	On Demand	Nil	77.05	77.05
Mahavir Texturising Pvt Ltd	Business Loan	Nil	On Demand	Nil	39.65	39.65
Paneri Textiles Pvt Ltd	Business Loan	Nil	On Demand	Nil	72.45	72.45
Praveen Ostwal	Business Loan	Nil	On Demand	Nil	-	7.00
Vesta Tex Pvt Ltd	Business Loan	Nil	On Demand	Nil	31.00	31.00
Visualize Tradecom Pvt Ltd	Business Loan	Nil	On Demand	Nil	-	20.00

**ANNEXURE – C****RESTATED STATEMENT OF DEFERRED TAX (ASSETS) / LIABILITIES**

(Amt in Lacs.)

Particulars	For the Period Ended	For the Period/year ended				
	11/30/2016	3/31/2016	3/31/2015	3/31/2014	3/31/2013	3/31/2012
Opening Balance (A)						
Opening Balance of Deferred Tax (Asset) / Liability	367.23	274.19	156.14	51.58	112.38	98.62
Current Year Provision (B)						
(DTA) / DTL on Depreciation	(103.05)	(23.01)	1.44	377.69	562.16	15.54
(DTA) / DTL on Provision for Gratuity/Carry Forward Losses	(180.01)	(116.05)	(116.60)	273.13	622.95	1.79
<b>Closing Balance of Deferred Tax (Asset) / Liability (A+B)</b>	<b>444.18</b>	<b>367.23</b>	<b>274.19</b>	<b>156.14</b>	<b>51.58</b>	<b>112.38</b>

Note: The above statement should be read with the significant accounting policies and notes to restated summary statement of profit and loss account and cash flows statement as appearing in Annexures IV, I, I and III .

**ANNEXURE – D****RESTATED STATEMENT OF TRADE PAYABLES**

(Amt in Lacs.)

PARTICULARS	As at					
	11/30/2016	3/31/2016	3/31/2015	3/31/2014	3/31/2013	3/31/2012
Trade Payables						
Micro, Small and Medium Enterprises	-	-	-	-	-	-
Other	722.53	318.27	1,227.61	1,042.30	681.32	212.05
<b>Total</b>	<b>722.53</b>	<b>318.27</b>	<b>1,227.61</b>	<b>1,042.30</b>	<b>681.32</b>	<b>212.05</b>

Notes:-

- The figures disclosed above are based on the restated summary statement of assets and liabilities of the Company.
- The above statement should be read with the significant accounting policies and notes to restated summary statements of assets and liabilities, profits and losses and cash flows appearing in Annexures IV, I, II and III.
- Amount due to entities covered under Micro, Small and Medium Enterprises as defined in the Micro, Small, Medium Enterprises Development Act, 2006, have been identified on the basis of information available with the Company. There was no amount due to any such entities which needs to be disclosed.

**ANNEXURE – E****RESTATED STATEMENT OF OTHER CURRENT LIABILITIES AND SHORT TERM PROVISIONS**

(Amt in Lacs.)

PARTICULARS	As at					
	11/30/2016	3/31/2016	3/31/2015	3/31/2014	3/31/2013	3/31/2012
<b>Other Current Liabilities</b>						
Current Maturity of Long Term Borrowings	150.92	298.18	237.44	160.00	135.00	108.73
Statutory Dues	27.31	21.70	24.98	31.40	10.08	9.41

Liabilities towards Staff & Workers	19.18	24.39	19.54	24.06	20.02	20.11
Other payables	-	-	7.58	22.34	22.26	31.49
Advances from customers	-	-	3.90	172.33	0.53	-
<b>Total</b>	<b>197.41</b>	<b>344.27</b>	<b>293.44</b>	<b>410.13</b>	<b>187.89</b>	<b>169.74</b>
<b>Short-Term Provisions</b>						
Provision for Current Year Tax	115.43	107.34	101.69	150.18	149.56	146.49
Provision for Exp	-	18.42	11.37	1.63	4.61	0.41
Provision for Gratuity	-	-	-	-	-	-
Provision for TDS Defaults as per 26AS	0.61	0.61	0.61	0.57	0.57	0.57
Income tax payable for earlier years	-	-	-	-	-	-
<b>Total</b>	<b>116.04</b>	<b>126.38</b>	<b>113.67</b>	<b>152.37</b>	<b>154.74</b>	<b>147.47</b>

Notes:-

1. The figures disclosed above are based on the restated summary statement of assets and liabilities of the Company.

2. The above statement should be read with the significant accounting policies and notes to restated summary statements of assets and liabilities, profits and losses and cash flows appearing in Annexures IV, I, II and III.

### ANNEXURE – F

#### RESTATED STATEMENT OF FIXED ASSETS

(Amt in Lacs.)

PARTICULARS	As at					
	11/30/2016	3/31/2016	3/31/2015	3/31/2014	3/31/2013	3/31/2012
<b>(i) Tangible Assets</b>						
Land	1553.56	1553.56	1553.56	1553.56	391.41	391.41
Cars	29.16	43.33	42.47	48.68	26.00	16.58
Computer & Printers	4.50	1.31	2.54	5.09	4.98	4.64
Electric Equipments	4.61	5.30	6.32	9.39	10.28	11.17
Electric Installation	202.90	173.46	218.96	273.84	239.60	206.05
Energy Saving Equipments	12.15	13.06	14.42	15.78	18.81	21.85
Factory Buildings	2129.59	1839.05	1825.50	1706.56	1215.62	440.15
Furniture & Fixtures	6.68	7.31	9.05	10.60	11.42	11.77
Heavy Vehicles	31.72	38.26	58.74	71.38	66.47	80.82
Lab Equipments	1.30	1.48	1.78	2.09	3.01	3.93
Office Buildings	127.74	129.17	130.62	76.61	27.51	27.99
Office Equipments	10.22	10.20	9.32	14.07	12.78	10.89
Plant & Machinery	3753.40	3093.43	3119.06	3424.20	2074.73	1436.23
Pollution Control Equipments	122.54	130.09	136.01	146.98	167.76	188.54
Roads	35.03	38.64	41.58	9.61	9.78	9.95
Tubewell	0.14	0.14	0.49	2.51	2.56	2.60
Two Wheeler	2.29	2.23	2.69	2.56	2.64	1.84
Weight Bridge	0.54	0.55	0.56	0.57	3.94	7.31
<b>Total Tangible Assets</b>	<b>8028.08</b>	<b>7080.56</b>	<b>7173.67</b>	<b>7374.07</b>	<b>4289.31</b>	<b>2873.72</b>
<b>(ii) Intangible Assets</b>						
Intangible Asset	0.73	0.10	0.17	0.27	0.41	0.17
<b>(iii) Capital Work-in-Progress</b>						

Capital Work-in-Progress	1487.81	810.72	862.67	19.80	905.32	1507.92
Intangible assets under development	0.00	0.00	0.00	0.00	0.00	0.00
<b>Grand Total</b>	<b>9516.62</b>	<b>7891.37</b>	<b>8036.51</b>	<b>7394.15</b>	<b>5195.04</b>	<b>4381.80</b>

Notes:-

1. The figures disclosed above are based on the restated summary statement of assets and liabilities of the Company.
2. The above statement should be read with the significant accounting policies and notes to restated summary statements of assets and liabilities, profits and losses and cash flows appearing in Annexures IV, I, II and III.

**ANNEXURE – G**

**RESTATED STATEMENT OF LONG-TERM LOANS AND ADVANCES**

(Amt in Lacs.)

PARTICULARS	As at					
	11/30/2016	3/31/2016	3/31/2015	3/31/2014	3/31/2013	3/31/2012
Unsecured, Considered Good unless otherwise stated						
MAT Credit Entitlement	-	-	-	-	-	-
Security Deposits	57.53	59.32	95.63	141.31	166.83	36.33
Gratuity LIC Fund	3.53	(0.65)	5.56	4.54	5.41	4.39
<b>Total</b>	<b>61.06</b>	<b>58.67</b>	<b>101.19</b>	<b>145.85</b>	<b>172.24</b>	<b>40.72</b>

Notes:-

1. The figures disclosed above are based on the restated summary statement of assets and liabilities of the Company.
2. The above statement should be read with the significant accounting policies and notes to restated summary statements of assets and liabilities, profits and losses and cash flows appearing in Annexure IV, I, II and III.

**ANNEXURE – H**

**RESTATED STATEMENT OF INVENTORIES**

(Amt in Lacs.)

PARTICULARS	As at					
	11/30/2016	3/31/2016	3/31/2015	3/31/2014	3/31/2013	3/31/2012
<b>Inventories</b>						
(a) Raw materials	482.37	293.64	352.63	944.69	536.98	172.07
(b) Work-in-progress	164.41	147.91	147.07	138.75	94.12	48.72
(c) Finished goods	1,574.10	1,086.32	2,609.50	2,165.41	1,220.48	266.10
<b>Total</b>	<b>2,220.88</b>	<b>1,527.86</b>	<b>3,109.40</b>	<b>3,248.98</b>	<b>1,851.60</b>	<b>486.89</b>

Note:- As per Management Explanation, Inventory has been physically verified by the management of the Company at the end of respective year

**ANNEXURE – I****RESTATED STATEMENT OF TRADE RECEIVABLES**

(Amt in Lacs.)

PARTICULARS	As At					
	11/30/2016	3/31/2016	3/31/2015	3/31/2014	3/31/2013	3/31/2012
Outstanding for a period exceeding six months						
<b>(Unsecured and considered Good)</b>						
From Directors/Promoters/ Promoter Group/Associates/ Relatives of Directors/ Group Companies.	-	-	-	-	-	-
Others	-	-	-	-	-	-
<b>(Unsecured and considered Doubtful)</b>						
From Directors/Promoters/Promoter Group/Associates/ Relatives of Directors/ Group Companies.						
Others	-	-	-	-	-	-
Outstanding for a period not exceeding 6 months <b>(Unsecured and considered Good)</b>						
From Directors/Promoters/Promoter Group/Associates/ Relatives of Directors/ Group Companies.						
Others	640.18	1,499.72	480.82	196.66	573.38	796.40
<b>Total</b>	<b>640.18</b>	<b>1,499.72</b>	<b>480.82</b>	<b>196.66</b>	<b>573.38</b>	<b>796.40</b>

Note:-

1. The figures disclosed above are based on the restated summary statement of assets and liabilities of the Company.
2. The above statement should be read with the significant accounting policies and notes to restated summary statements of assets and liabilities, profits and losses and cash flows appearing in Annexures IV, I, II and III.

**ANNEXURE – J****RESTATED STATEMENT OF CASH & CASH EQUIVALENTS**

(Amt in Lacs.)

PARTICULARS	As at					
	11/30/2016	3/31/2016	3/31/2015	3/31/2014	3/31/2013	3/31/2012
Cash in Hand (As Certified by Management)	10.97	5.37	5.22	4.64	3.49	0.98
<b>Balances with Banks</b>						
- In Current Accounts	4.60	0.72	10.09	4.10	1.86	27.85
<b>Total</b>	<b>15.57</b>	<b>6.09</b>	<b>15.31</b>	<b>8.74</b>	<b>5.35</b>	<b>28.83</b>

Note:-

1. The figures disclosed above are based on the restated summary statement of assets and liabilities of the Company.
2. The above statement should be read with the significant accounting policies and notes to restated summary statements of assets and liabilities, profits and losses and cash flows appearing in Annexures IV, I, II and III.



**ANNEXURE – K****RESTATED STATEMENT OF SHORT-TERM LOANS AND ADVANCES**

(Amt in Lacs.)

PARTICULARS	As at					
	11/30/2016	3/31/2016	3/31/2015	3/31/2014	3/31/2013	3/31/2012
Advance Taxes	30.00	50.00	72.00	120.00	135.00	125.00
Prepaid Expenses	6.18	30.71	27.69	38.17	21.28	9.50
Loan to Employees	4.63	-	5.48	2.54	3.03	4.13
Advances to suppliers	237.27	191.90	66.28	77.67	63.75	28.59
Output Vat Advance	258.81	306.39	274.53	-	111.69	55.14
Capital Advances	-	-	-	-	-	44.81
Others	-	-	-	-	-	0.20
<b>Total</b>	<b>536.89</b>	<b>579.00</b>	<b>445.98</b>	<b>238.38</b>	<b>334.75</b>	<b>267.37</b>

**Note:-**

1. The figures disclosed above are based on the restated summary statement of assets and liabilities of the Company.
2. The above statement should be read with the significant accounting policies and notes to restated summary statements of assets and liabilities, profits and losses and cash flows appearing in Annexures IV, I, II and III.

**ANNEXURE – L****RESTATED STATEMENT OF OTHER CURRENT ASSETS**

(Amt in Lacs.)

PARTICULARS	As at					
	11/30/2016	3/31/2016	3/31/2015	3/31/2014	3/31/2013	3/31/2012
TDS Receivable	1.44	9.40	1.89	1.74	0.67	0.16
Cenvat Credit	-	-	-	-	-	-
<b>Total</b>	<b>1.44</b>	<b>9.40</b>	<b>1.89</b>	<b>1.74</b>	<b>0.67</b>	<b>0.16</b>

**Note:-**

1. The figures disclosed above are based on the restated summary statement of assets and liabilities of the Company.
2. The above statement should be read with the significant accounting policies and notes to restated summary statements of assets and liabilities, profits and losses and cash flows appearing in Annexures IV, I, II and III.

**ANNEXURE – M****RESTATED STATEMENT OF OTHER INCOME**

(Amt in Lacs.)

Particulars	For the Period Ended	For the year ended				
	11/30/2016	3/31/2016	3/31/2015	3/31/2014	3/31/2013	3/31/2012
Related and Recurring Income:	1.60	155.23	444.99	43.30	164.97	166.03
Non-related and Non-recurring income:	54.52	-	-	-	0.19	-
<b>Total</b>	<b>56.12</b>	<b>155.23</b>	<b>444.99</b>	<b>43.30</b>	<b>165.16</b>	<b>166.03</b>

**Note:-**

1. The classification of other income as recurring/not-recurring, related/not-related to business activity is based on the current operations and business activity of the Company as determined by the management.
2. The figures disclosed above are based on the restated summary statement of assets and liabilities of the Company.
3. The above statement should be read with the significant accounting policies and notes to restated summary statements of assets and liabilities, profits and losses and cash flows appearing in Annexures IV, I, II and III.

**ANNEXURE – N****RESTATED STATEMENT OF TURNOVER**

(Amt in Lacs.)

Particulars	For the Period Ended	For the year ended				
	11/30/2016	3/31/2016	3/31/2015	3/31/2014	3/31/2013	3/31/2012
Proceeds from Sale of Product	4,463.52	8,699.76	7,280.83	9,040.40	4,022.04	2,527.25
Proceeds from Sale of Services	-	207.68	-	-	-	-
<b>Total</b>	<b>4,463.52</b>	<b>8,907.44</b>	<b>7,280.83</b>	<b>9,040.40</b>	<b>4,022.04</b>	<b>2,527.25</b>

1. The figures disclosed above are based on the restated summary statement of assets and liabilities of the Company.

2. The above statement should be read with the significant accounting policies and notes to restated summary statements of assets and liabilities, profits and losses and cash flows appearing in Annexures IV, I, II and III.

**ANNEXURE – O****RESTATED STATEMENT OF MANDATORY ACCOUNTING RATIOS**

(Amt in Lacs.)

Particulars	As at					
	11/30/2016	3/31/2016	3/31/2015	3/31/2014	3/31/2013	3/31/2012
Net Worth	8,719.52	7,495.25	7,315.36	6,557.00	4,084.23	3,690.74
Less: Revaluation reserves	(2,947.67)	(3,032.29)	(3,167.71)	(3,296.48)	(1,328.25)	(1,570.59)
<b>Net Worth (A)</b>	<b>5,771.84</b>	<b>4,462.96</b>	<b>4,147.65</b>	<b>3,260.52</b>	<b>2,755.98</b>	<b>2,120.15</b>
Restated Profit after tax	392.39	315.30	292.79	504.54	635.83	343.88
Adjusted Profit after Tax (B)	392.39	315.30	292.79	504.54	635.83	343.88
Number of Equity Share outstanding as on the End of Year/Period ( C)	249.00	210.00	210.00	180.00	180.00	180.00
Weighted average no of Equity shares at the time of end of the year (D)	219.11	210.00	191.10	180.00	180.00	150.16
Current Assets (E)	3,414.96	3,622.07	4,053.40	3,694.51	2,765.75	1,579.65
Current Liabilities (F)	2,320.14	2,447.89	3,324.73	3,257.00	2,184.75	692.35
Face Value per Share (in Rs.)	10.00	10.00	10.00	10.00	10.00	10.00
Restated Basic and Diluted Earning Per Share (Rs.) (B/D) Refer Note 1 given below	1.79	1.50	1.53	2.80	3.53	2.29
Return on Net worth (%) (B/A)	6.80	7.06	7.06	15.47	23.07	16.22
Net asset value per share (A/C)	23.18	21.25	19.75	18.11	15.31	11.78
Adjusted Net asset value per share based on Weighted average number of share (A/D)	26.34	21.25	21.70	18.11	15.31	14.12
Current Ratio (E/F)	1.47	1.48	1.22	1.13	1.27	2.28

Note:-

1) The ratios have been computed as below:

(a) Basic earnings per share (Rs. ) - : Net profit after tax as restated for calculating basic EPS / Weighted average number of equity shares outstanding at the end of the period or year

(b) Diluted earnings per share (Rs. ) - : Net profit after tax as restated for calculating diluted EPS / Weighted average number of equity shares outstanding at the end of the period or year for diluted EPS

(c) Return on net worth (%) -: Net profit after tax (as restated) / Net worth at the end of the period or year

- (d) Net assets value per share -: Net Worth at the end of the period or year / Total number of equity shares outstanding at the end of the period or year
- (e) Net assets value per share (effect of bonus issue of equity shares) - : Net Worth at the end of the period or year / Total number of equity shares outstanding at the end of the period or year (after split and bonus issue)
- 2) Weighted average number of equity shares is the number of equity shares outstanding at the beginning of the period/year adjusted by the number of equity shares issued during period/year multiplied by the time weighting factor. The time weighting factor is the number of days for which the specific shares are outstanding as a proportion of total number of days during the period/year.
- 3) Net worth for ratios mentioned in note 1(c) and 1(d) is = Equity share capital + Reserves and surplus ( including, Securities Premium, General Reserve and surplus in statement of profit and loss).
- 4) The figures disclosed above are based on the standalone restated summary statements of the Group.
- 5) The above statement should be read with the significant accounting policies and notes to restated summary statements of assets and liabilities, profits and losses and cash flows appearing in Annexures IV, I, II and III.

**ANNEXURE – P****RESTATED STATEMENT OF CAPITALISATION**

(Amt in Lacs.)

Particulars	Pre-Issue	Post-Issue*
	11/30/2016	
Debt		
Short Term Debt	2,320.14	2,320.14
Long Term Debt	1,952.97	1,952.97
Total Debt	4,273.12	4,273.12
Shareholders' Fund (Equity)		
Share Capital	2,490.00	2,490.00
Reserves & Surplus	6,229.52	6,229.52
Less: Miscellaneous Expenses not w/off	-	-
Total Shareholders' Fund (Equity)	8,719.52	8,719.52
Long Term Debt/Equity	0.22	0.22
Total Debt/Equity	0.49	0.49

Notes:

- Short term Debts represent which are expected to be paid/payable within 12 months.
- Long term Debts represent debts other than Short term Debts as defined above.
- The figures disclosed above are based on restated statement of Assets and Liabilities of the Company as at 30/11/2016.

**ANNEXURE – Q****RESTATED STATEMENT OF RELATED PARTY TRANSACTION**

(Amt in Lacs)

a)	Names of the related parties with whom transaction were carried out during the years and description of relationship:	
1	Holding Company	Ostwal Phoschem (India) Limited (Formerly known as Tedco Granite Limited)
2	Subsidiary Companies	Nil
3	Key Managerial Person	Mr. Praveen Ostwal
		Mr. Sunil Kothari
4	Relatives of Key Management Personnel with whom transactions have taken place	Mr. Mahendra Kumar Ostwal
		Mr. Pankaj Ostwal
		Mrs. Nitu Ostwal
		Praveen Ostwal HUF
		Mahendra Kumar Ostwal HUF
5	Enterprises Owned or controlled by	Seasons Agro Chem India Pvt. Ltd.



	Pvt. Ltd.						
	Ostwal Phoschem (India) Ltd.	26.64	1,420.67	823.13	-	-	170.00
	R.V. Spinners Pvt. Ltd.	-	-	-	70.00	-	-
<b>5</b>	<b><u>Loan Repaid</u></b>						
	Mr. Praveen Ostwal		34.00	-	-	-	-
	Madhya Bharat Agro Products Ltd.	1,379.83	30.00	-	-	-	1,023.80
	Seasons International Pvt. Ltd.	686.00	2,749.07	-	55.00	-	72.00
	Alovera Tradelink Pvt. Ltd.	22.35	50.00	9.45	50.00	60.00	-
	Archid Product Pvt. Ltd.	48.83	51.90	1.93	90.00	10.00	-
	Chunri Prints Pvt. Ltd.	-	25.00	13.00	-	-	-
	Destiny Exim Pvt. Ltd.	26.85	52.25	-	70.45	50.00	-
	Dove Creation Pvt. Ltd.	34.76	44.76	6.56	110.00	35.00	-
	Duggal Tex Pvt. Ltd.	39.95	79.55	5.06	110.00	25.00	-
	Kolaveri Textile Pvt. Ltd.	-	4.00	25.00	-	25.00	-
	Paneri Textiles Pvt. Ltd.	-	31.60	10.00	-	-	-
	Seasons Agro Chem India Pvt. Ltd.	-	895.50	-	-	-	100.00
	Nirmala Realinfrastructure Pvt. Ltd.	-	-	-	-	-	40.00
	Ostwal Phoschem (India) Ltd.	26.64	1,420.67	823.13	-	-	165.00
	R.V. Spinners Pvt. Ltd.	-	-	-	70.00	-	-
<b>6</b>	<b><u>Rent Paid</u></b>						
	Seasons International Pvt. Ltd.	-	0.02	-	-	-	-
	Ostwal Phoschem (India) Ltd.	-	0.05	-	-	-	-

**ANNEXURE – R**

**RESTATED STATEMENT OF CONTINGENT LIABILITIES**

(Amt in Lacs.)

Particulars	As at					
	11/30/2016	3/31/2016	3/31/2015	3/31/2014	3/31/2013	3/31/2012
Contingent liabilities in respect of:						
Income Tax demands / Notices before CIT Appeals	-	-	-	-	-	-
Indirect Tax demands/ Notices	0.42	-	-	-	-	-
Other moneys for which the promoter is contingently liable	-					
Guarantees given on Behalf of the Company	-	-	-	-	-	-
Guarantees given on Behalf of the Subsidiary Company	-	-	-	-	-	-
Commitments (to the extent not provided for)	-	-	-	-	-	-
Estimated amount of contracts remaining to be executed on capital account and not provided for	-	-	-	-	-	-

Uncalled liability on shares and other investments partly paid	-	-	-	-	-	-
Other commitments		-	-	-	-	-
<b>Total</b>	<b>0.42</b>	-	-	-	-	-

Notes:-

1. The figures disclosed above are based on the restated summary statement of assets and liabilities of the Company.

2. The above statement should be read with the significant accounting policies and notes to restated summary statements of assets and liabilities, profits and losses and cash flows appearing in Annexures IV, I, II and III.

**ANNEXURE – S**

**RESTATED STATEMENT OF TAX SHELTER**

(Amt in Lacs.)

Particulars	As at					
	11/30/2016	3/31/2016	3/31/2015	3/31/2014	3/31/2013	3/31/2012
Restated Net Profit/(Loss) before taxes (A)	583.30	506.19	517.26	755.32	757.18	511.35
Tax Rate Applicable %	30.90%	30.90%	30.90%	30.90%	30.90%	32.45%
Minimum Alternate Taxes (MAT)	20.39%	20.39%	20.01%	20.01%	20.01%	20.01%
<b>Tax at Notional Rate</b>	<b>180.24</b>	<b>156.41</b>	<b>159.83</b>	<b>233.39</b>	<b>233.97</b>	<b>165.91</b>
<b>Adjustments:</b>						
<b>Impact of Timing Difference on Total Income due to:</b>						
Add: Difference of Depreciation as per Companies Act and Income-tax Act	(8.08)	268.20	262.11	260.07	33.03	(66.70)
Add: Deduction Allowed/ Disallowed u/s 43B	-	6.24	(4.20)	0.06	0.98	0.25
Add: Gratuity Contributions/Provisions	(4.17)	6.20	(1.02)	0.88	(1.02)	(0.67)
<b>Impact of Permanent Difference on Total Income due to:</b>						
Add:- TDS Demand as per 26 AS	-	-	0.05	-	0.00	0.57
Add: Donation Paid not Allowed Under Income Tax	-	3.00	0.82	0.61	-	-
Add: Loss by Sale (Fixed Assets)	0.73	0.10	-	2.88	0.01	0.29
Add: Disallowed U/s 36/37	-	9.86	2.34	5.71	0.01	5.72
<b>Net Adjustments (B)</b>	<b>(11.52)</b>	<b>293.60</b>	<b>260.09</b>	<b>270.20</b>	<b>33.00</b>	<b>(60.54)</b>
Business Income (A+B)	571.78	799.79	777.35	1,025.52	790.18	450.81
Deduction u/s 35AD	(9.76)	(412.47)	(408.01)	(1,909.42)	(2,804.88)	-
Less: Unabsorbed Losses of Specified Business to be utilised for Set-Off	(562.02)	(393.52)	(368.93)	-	-	-
Gross Total Income	-	(6.20)	0.41	(883.90)	(2,014.70)	450.81
Less: Deduction under Chapter VIA	-	(1.50)	(0.41)	(0.31)	-	-
Total Income	-	(7.70)	(0.00)	(884.20)	(2,014.70)	450.81
Current Year Unabsorbed Losses of	-	-	-	884.20	2,014.70	-

Specified Business to be C/F						
Accumulated Unabsorbed Losses of Specified Business to be C/F	1,574.44	2,136.45	2,529.97	2,898.90	2,014.70	-
Tax Payable as per Normal Rate	-	0.00	-	-	-	146.27
MAT Credit Set Off	-	-	-	-	-	-
Tax as per Income Tax (D )	-	0.00	-	-	-	146.27
<b>Computation of Book Profits</b>						
PBT as per P&L	583.30	506.19	517.26	755.32	757.18	511.35
Add: Interest on Income tax debited to P&L before tax	-	2.74	2.34	2.80	-	-
Book Profits	583.30	508.93	519.60	758.12	757.18	511.35
Tax Payable as per Minimum Alternate Tax U/s 115 JB of the Income Tax Act, 1961 (D)	118.93	103.77	103.96	151.68	151.49	102.31
Net Tax (Higher of C & D)	118.93	103.77	103.96	151.68	151.49	146.27
Tax Payable on Restated Profits	118.93	103.77	103.96	151.68	151.49	146.27

**Notes:**

1. The aforesaid statement of tax shelters has been prepared as per the restated Summary statement of profits and losses of the Company. The permanent/timing differences have been computed considering the acknowledged copies of the income-tax respective years stated above. The changes in the tax liability and the interest thereon arising on account of assessment proceedings, notices, appeals etc has been adjusted in the tax liability of the year to which the liability pertains.
2. The figures disclosed above are based on the restated summary statement of assets and liabilities of the Company, Income Tax Depreciation was recalculated due to regrouping of Assets and capitalization of few payment expenses from Revenue to Fixed Assets, due to which depreciation was recalculated and revised depreciation considered for above calculation.
3. The figures for the year ended November 30, 2016 are based on the provisional computation of Total Income prepared by the Company
4. The above statement should be read with the significant accounting policies and notes to restated summary statements of assets and liabilities, profits and losses and cash flows appearing in Annexures IV, I, II and III.

**STATEMENT OF FINANCIAL INDEBTEDNESS**

To,

The Board of Directors,  
 Krishana Phoschem Limited  
 5-O-20 Basement R.C Vyas Colony  
 Bhilwara, Rajasthan – 311001, India.

Dear Sir,

The principal terms of loans as on 30<sup>th</sup> November, 2016 is as given below:**A. Secured Loans:-****(Amount in Lakhs)**

Name of Lender	Purpose	Loan\ Agreement A/c No.	Sanctioned Amount (In Lacs)	Rate of interest	Primary Security	Collateral/Other Security	Re-Payment Schedule	Moratorium	Outstanding amount as on 30.11.2016 as per Books	Outstanding amount as on 31.03.2016 as per Books
HDFC Bank	Cash Credit	50200 00742 3685	1,700.00	11.30%	Hypothecation by way of first and exclusive charge on all present and future Stocks & Books Debts	1. Factory Land & Building Situated at Plot No. 115, 116, 117, 118-A, 118-B, 119, 120, 126 to 133, 142, 143 Megh Nagar, Jhabua, M.P. - 457661	Monthly	-	1,164.13	1,658.97
	Buyers Credit	82172 787	122.00	11.40%		2. Plot At A-07 (Araji No 189), Kumud Vihar Yojana, Akola-Bhilwara - 311607	Monthly	-	120.03	-
	Working Capital Term Loan	81227 843	252.01	11.30%		3. Plot No. 126A & 134, Megh Nagar, Jhabua, M.P.- 457779	Monthly	-	103.97	159.18
	Working Capital Term Loan	81236 098	871.76	11.30%			Monthly	-	545.80	667.88
	Working Capital Term Loan	81882 517	519.11	11.30%			Monthly	-	504.55	300.00
<b>Total</b>			<b>3,464.88</b>						<b>2,438.49</b>	<b>2,786.03</b>

**Terms and Conditions as per sanction letter:**

- All interest rates are base rate linked. The interest rate is subject to changes in the Base Rate of HDFC Bank from time to time.
- Bank reserves an unconditional right to cancel/terminate the right of the Borrower to avail of or make draws from the unavailed portion of the Loan / facility sanctioned at any time during the currency of the Loan/facility, without any prior notice to the borrower.



3. The availability of working capital facilities will be subject to availability of Drawing Power (DP) calculated as per the HDFC Bank's Norms. Borrower is required to submit monthly stock and book debts statements.
4. Borrower to provide copy of comprehensive Insurance on all stocks, movable and immovable assets and other secured assets with assignment in favor of HDFC Bank as First loss payee.

**B. Unsecured Loans**

Name of Lender	Purpose	Rate of interest	Re-Payment Schedule	Moratorium	Outstanding Amount As On (as per Books)	
					30.11.2016	31.03.2016
Alovera Tradelink Pvt Ltd	Business Loan	Nil	On Demand	Nil	40.35	22.35
Archid Product Pvt Ltd	Business Loan	Nil	On Demand	Nil	48.83	48.83
Chunri Prints Pvt Ltd	Business Loan	Nil	On Demand	Nil	56.00	56.00
Destiny Exim Pvt Ltd	Business Loan	Nil	On Demand	Nil	38.35	10.85
Dove Creation Pvt Ltd	Business Loan	Nil	On Demand	Nil	34.76	34.76
Duggal Tax Pvt Ltd	Business Loan	Nil	On Demand	Nil	39.95	39.95
Kolaveri Textile Pvt Ltd	Business Loan	Nil	On Demand	Nil	77.05	77.05
Mahavir Texturising Pvt Ltd	Business Loan	Nil	On Demand	Nil	39.65	39.65
Paneri Textiles Pvt Ltd	Business Loan	Nil	On Demand	Nil	72.45	72.45
Praveen Ostwal	Business Loan	Nil	On Demand	Nil	7.00	-
Vesta Tex Pvt Ltd	Business Loan	Nil	On Demand	Nil	31.00	31.00
Visualize Tradecom Pvt Ltd	Business Loan	Nil	On Demand	Nil	20.00	-

**Terms and Conditions:**

All Unsecured Loans from Directors/Promoters/Group Companies and other Companies are interest free and all are taken without any preconditions attached towards.

**For Mansaka Ravi & Associates**  
**Chartered Accountants**  
**FRN. : 015023C**

**CA Ravi Mansaka**  
**(Partner)**  
**Membership No. 410816**

**Place: Jaipur**  
**Date: December 26, 2016**

**MANAGEMENT'S DISCUSSION AND ANALYSIS OF FINANCIAL CONDITIONS AND RESULTS OF OPERATIONS**

*You should read the following discussion of our financial condition and results of operations together with our restated financial statements included in the Prospectus. You should also read the section entitled "Risk Factors" beginning on page 16 and "Forward Looking Statements" beginning on page 15 which discusses a number of factors, risks and contingencies that could affect our financial condition and results of operations.*

*The following discussion of our financial condition and results of operations should be read in conjunction with our restated financial statements for the period ended November 30, 2016 and for the fiscal years ended March 31, 2016, 2015, 2014, 2013 and 2012, including the schedules and notes thereto and the reports thereto, which appear in the section titled "Financial Information of the Company" on Page 157 of the Prospectus. The financial statements presented and discussed herein have been prepared to comply in all material respects with the notified accounting standards by Companies (Accounting Standards) Rules, 2006 (as amended), the relevant provisions of the Companies Act and SEBI (Issue of Capital and Disclosure Requirements) Regulations. Our fiscal year ends on March 31 of each year. Accordingly, all references to a particular fiscal year/financial year are to the twelve-month period ended on March 31 of that year. The forward-looking statements contained in this discussion and analysis is subject to a variety of factors that could cause actual results to differ materially from those contemplated by such statements.*

**Overview**

Incorporated in 2004, we are primarily engaged in manufacturing of fertilizers, intermediate dyes and other allied chemical products in the state of Madhya Pradesh. We are manufacturers of Benefited Rock Phosphate (BRP), Single Super Phosphate (SSP), Granulated Single Super Phosphate (GSSP), H-Acid, intermediate dyes and other allied chemicals. Our products Single Super Phosphate (SSP) and Granulated Single Super Phosphate (GSSP) is used in replenishing "P" (Phosphorous) in the soil and act as a fertilizer for crop. Initially our company was engaged in manufacturing of BRP and further expanded to forward integration in manufacturing of SSP and GSSP and expanding for Diversification in intermediate dyes and other allied chemicals.

Our Company manufacture specialized chemicals used for dyeing cloth such as H acid, E K acid, Vinyl sulphone, PNCBOSA, 4 sulphoantranilic acid, Violet acid, Sulpho Tobias acid. The chemicals produce by our company is used as Dye intermediate specifically for textiles Industry.

Our manufacturing facilities are located near the Jhabua, Meghnagar District (M.P), and distributed in two units, viz:

- Unit - I located at 115-120 & 126-133, A.K.V.N. Industrial Area, Meghnagar, Jhabua, Madhya Pradesh installed with production capacity of 200000 MT of Beneficiated Rock Phosphate (BRP), 120000 MT of Single Super Phosphate (SSP) and 90000 MT of Granulated Single Super Phosphate (GSSP).
- Unit - II located at 142 & 143, AKVN Industrial Area, Meghnagar, Jhabua, Madhya Pradesh with installed capacity of acids and other chemicals such as E K Acid, H Acid, H-ACID (By Production from E K Acid), PNCBOSA, Sulpho Anthranilic Acid, Sulpho tobias Acid (STA), Vinyl Sulphone and Violet Acid.

In Addition to above, our company is in process for installation of Unit - III located at 126 A & 134, AKVN Industrial Area, Meghnagar, Jhabua, Madhya Pradesh for manufacturing of sulphuric acid, Chloro sulphonic Acid, Liquid SO<sub>3</sub> and other allied chemicals. Sulphuric acid is a highly corrosive strong mineral acidulfuric acid has a wide range of applications including in domestic acidic drain cleaners, as an electrolyte in lead-acid batteries and in various cleaning agents. It is also a central substance in the chemical industry.

We are an ISO 9001:2008 certified company for manufacturing & supply of Benefited Rock Phosphate (BRP), Single Super Phosphate (SSP) and Granulated Single Super Phosphate (GSSP). Our manufacturing facilities are well equipped with required facilities including machinery, Feed Hopper, Conveyor Belt, Crusher and other handling equipments to facilitate smooth manufacturing process.

Our Company was initially promoted by Mr. Roop Lal Patel, Mrs. Leela Patel, Mr. Jitendra Patel, Mr. Vinod Paliwal, Mrs. Geeta Paliwal, Mr. Narendra Paliwal and Mr. Dilip Kumar Gadia with an object for manufacturing of fertilizers and has successfully implemented the SSP plant at Unit I in the year 2004. The commercial production was started in year 2005-06. Later in the year 2007 the company was taken-over by Mr. Praveen Ostwal and Seasons Agro Chem India Pvt. Ltd. Presently Mr. Praveen Ostwal, Ostwal Phoschem (India) Limited and Seasons Agro Chem India Pvt. Ltd. are Promoters of the Company.

We have entered into the marketing arrangement by signing an Supply and Purchase agreement dated March 20, 2015 for our product SSP with DCM Shriram Limited (through its unit M/s Shriram Fertilizers & Chemicals) for a period of five years, for supply of SSP minimum 40000 Mt per annum. Additionally Rock phosphate and Sulphuric acid are captively consumed to manufacture SSP fertilizer. The other main ingredient of raw material for SSP i.e. Sulphuric Acid is procured from Hindustan Zinc Limited (HZL) and B Roshan Lal & Chemicals Pvt. Limited etc. We have an excellent business relationship with HZL from a long period of time. Additionally to make fully integrated manufacturing facility, we are in process of setting Unit – III for manufacturing of Sulphuric acid to fulfill the requirement of raw material for manufacturing of SSP and thereby to enter into backward integration. We have quality control checks before any consignment of Raw material is accepted since it has a direct impact on the quality of Finished Product.

Our Company has established a quality control laboratory for analyzing samples of ore received from the mine, regular samples from the process of various streams, reagents and effluents. Rock phosphate samples are analyzed by volumetric/gravimetric methods and use of Instruments like P-H meter, Spectroscope, Electronic weigh Balance, Oven, Muffle furnace etc., and slurry sample preparation requires vacuum filtration and drying. Samples are preserved for some period as reference samples.

For the period ended November 30, 2016 our Company’s Total Revenue and Restated Profit after Tax were Rs. 4519.64 Lacs and Rs. 392.39 Lacs, respectively. For the year ended March 31, 2016, our Company’s Total Revenue and Restated Profit after Tax were Rs. 9062.67 Lacs and Rs. 315.30 Lacs, respectively. For the year ended March 31, 2015, our Company’s Total Revenue and Restated Profit after Tax was Rs. 7725.82 Lacs and Rs. 292.79 Lakhs respectively, compared to our Company’s Total Income and Restated Profit after Tax of Rs. 9083.70 Lacs and Rs. 504.54 Lacs respectively, over previous year ended i.e. March 31, 2014.

**Our Products:-**

S.No.	Products	Description
1.	<b>Beneficiated Rock Phosphate (BRP)</b>	Beneficiated Rock Phosphate (BRP) is Industrial product in nature as the same is used as raw material by Manufacturing Units producing SSP (Single Super phosphate). The basic raw material used is Rock Phosphate since beneficiation is a process done on Rock Phosphate to remove its impurities. Beneficiation is a process by which valuable constituents of an ore are concentrated by means of a physical separation.
2.	<b>Single Super Phosphate (SSP)</b>	Single Superphosphate is produced by reacting naturally occurring phosphate rock with sulphuric acid. This process converts insoluble phosphates into forms more readily available to plants. Single Super Phosphate (SSP) is used by farmers to improve the productivity levels of their soil which get eroded each year. SSP is used in large quantities for replenishing “P” (Phosphorus) in the soil which gets depleted steadily with each crop. This is preferred phosphate fertilizer by the farmers as it provides much needed nutrients “S” along with “P” unlike other fertilizer.
3.	<b>Granulated Single Super Phosphate (GSSP)</b>	Single Super phosphate (SSP) in form of granulated form is called Granulated Single Super Phosphate. The use of granulated product is more beneficial than the use of powder. The granulated product rolls down the plant and can be used harmlessly on the standing crops. The biggest advantage in using the granulated product is that it is available to the crops for a longer time because it gets dissolved slowly in water.
4.	<b>Intermediate Dyes and other chemicals</b>	Acid includes Di-Calsiam Phosphate (DCP), E K Acid, H Acid, H-ACID (By Production from E K Acid), PNCBOSA, Solpho Anthranilic Acid, Sulpho tobias Acid (STA), Vinyl Sulphone and Violet Acid.

**OUR LOCATION:-**

<b>Registered Office &amp; Head Office</b>	5-O-20 Basement R.C Vyas Colony, Bhilwara- 311001, Rajasthan
<b>Factory</b>	<b>Unit I</b> –115-120 & 126 -133 AKVN Industrial area, Meghnagar, Jhabua, Madhya Pradesh.
	<b>Unit II</b> – 142 & 143, AKVN Industrial Area, Meghnagar, Jhabua, Madhya Pradesh
	<b>Unit III</b> – 126 A & 134, AKVN Industrial Area, Meghnagar, Jhabua, Madhya Pradesh
<b>Godown</b>	Khasra No. 667 and 668, Village Ojayada, Hamirgarh, Dist. Bhilwara, Rajasthan

**OUR BUSINESS STRENGTH:-****1. Cost Effective sourcing and Strategic Location of Manufacturing Unit:-**

We believe that our cost efficient manufacturing and supply chain management results in a significant reduction in our operational costs. With our experience, we are able to gauge our procurement of raw materials in timely manner. Further, our manufacturing units, situated within the state of Madhya Pradesh are ensured with sufficient raw material which is locally procured. The location of our current manufacturing facilities gives us a significant competitive cost advantage in terms of raw material sourcing manufacturing and labour costs and enables us to address the western markets efficiently.

**2. Quality assurance**

Our Company has a testing division and an in house laboratory which is responsible for the final approval of product manufactured. The final product manufactured has to undergo a quality check before it is finally packed and dispatch. We also have quality control checks before any consignment of Raw material is accepted since it has a direct impact on the quality of Finished Product. Our Quality assurance has enabled us provide satisfactory performance to our Customer.

**3. Leveraging the expertise of our Promoters and Management Team:-**

Our Promoters are engaged in Mineral beneficiation plant and Fertilizer Industries, which also form part of Board of Directors of our Company. Also, our Company is managed by a team of professional & experienced personnel. The team comprises of personnel having operational and business development experience. We believe that our management team's experience and their understanding of the industry will enable us to continue to take advantage of both current and future market opportunities. It is also expected to help us in addressing and mitigating various risks inherent in our business, including significant competition and the global economic crisis.

**4. Forward integration and Diversification:-**

Initially our company was engaged in manufacturing of Beneficiated Rock Phosphate (BRP) in Unit – I with installed capacity of 2,00,000 MT. As a step towards forward integration our Company has set up a manufacturing facilities for production of Single Super Phosphate (SSP) with an installed processing capacity of 1,20,000 MT in the year 2012-13 and production of Granulated Single Super Phosphate (GSSP) with an installed processing capacity of 90,000 MT in the year 2013-14 at Unit –I situated at 115-120 & 126-133 A.K.V.N Industrial area, Meghnagar, Jhabua (M.P.), Madhya Pradesh. Furthermore we have diversified our business into manufacturing of intermediate dyes and other allied chemicals in our Unit II situated at Meghnagar, Jhabua, Madhya Pradesh.

**5. Existing relationship with suppliers:-**

We buy low grade rock from Madhya Pradesh State Mines and Minerals Limited and sulphuric acid from Hindustan Zinc Limited and B Roshan Lal & Chemicals Private Limited etc. We had also entered into a Memorandum of Understanding dated September 02, 2004 with Madhya Pradesh State Mining Corporation for purchase of low-grade rock for a period of 10 years. Based on our relationship with supplier, we are still procuring our raw material i.e. Rock Phosphate from MPSMC. Also we have acquired other raw materials from several suppliers and have maintained relationship with them for a long time. Due to our relationships with our suppliers, we get quality and timely supplies of raw materials. This enables us to manage our inventories and supply quality products.

**OUR BUSINESS STRATEGIES:-**

**1. Optimal Utilization of Resources:-**

Our Company constantly endeavors to improve our manufacturing process, and will increase service activities to optimize the utilization of resources. We have invested significant resources, and intend to further invest in our activities to develop customized systems and processes to ensure effective management control. We regularly analyze our existing policies to be carried out for our manufacturing process which enables us to identify the areas of bottlenecks and correct the same. This helps us in improving efficiency and putting resources to optimal use.

**2. Continue to invest significantly in R&D**

We intend to increase our initiatives in R & D in order to constantly study industry verticals to identify product inefficiencies in areas in which we could add value. Going forward, we intend to expand our research and development capabilities, by increasing our investment in employing qualified individuals from the industry thereby augmenting our dedicated in-house R&D team. We believe that continued investments in R&D will enable us to increase our productivity, improve our operating efficiency, and enable us to penetrate existing and new market segments.

**3. To build-up a professional organization:-**

As an organization, we believe in transparency and commitment in our work and with our customers. We have an experienced team for taking care of our day to day operations. We also consult with external agencies on a case to case basis on technical and financial aspects of our business. We will consistently put efforts among its group of experienced employees to transform them into an outstanding team of empowered professionals which helps in further accelerating the wheels of development of the Organization.

**4. Develop and maintain relationships with our Suppliers and Customers:-**

We believe in maintaining good relationship with our Suppliers and Customers which is the most important factor to keep our Company growing. Our dedicated and focused approach and efficient and timely delivery of products has helped us build strong relationships over a number of years. We bag and place repetitive order with our customers as well as with our suppliers. For us, establishing strong, mutually beneficial long-term relationships with strategic supplier relationship management is a critical step in improving performance across the supply chain, generating greater cost efficiency and enabling the business to grow and develop.

**5. Broaden and Deepen Our Geographical Presence**

We intend to deepen market penetration and increase our market share for existing products, as well as to position ourselves to successfully commercialize our products under development and any additional products for which we may receive approval. We may either form important relationships with companies with strong local presence through whom we can undertake our own sales and marketing.

**SWOT ANALYSIS:**

<u>Strengths</u>	<u>Weakness</u>
<ul style="list-style-type: none"> <li>➤ Well Established Manufacturing facility</li> <li>➤ Quality assurance and Standard</li> <li>➤ Experienced Management Team.</li> <li>➤ Long term Trade</li> <li>➤ Proximity to Raw Material (Low Grade Rock Phosphate &amp; Sulphur) &amp; Long Term Agreements</li> <li>➤ Supportive Central and State Government Policies.</li> </ul>	<ul style="list-style-type: none"> <li>➤ Working Capital Intensive Business</li> <li>➤ Low bargaining power with customers</li> </ul>
<u>Opportunities</u>	<u>Threats</u>
<ul style="list-style-type: none"> <li>➤ High Growth Potential</li> <li>➤ Government Initiatives for fertilizer Industry</li> </ul>	<ul style="list-style-type: none"> <li>➤ Industry is prone to change in government policies</li> <li>➤ Government intervention</li> </ul>

**CAPACITY UTILISATION:-**

Particulars	Existing			Proposed			
	2013-14	2014-15	2015-16	Nov, 2016	March, 2017	2017-18	2018-19
<b>Unit - I</b>							
<b>Beneficiated Rock Phosphate (BRP)</b>							
Total Installed Capacity (Metric tonnes)	200000	200000	200000	200000	200000	200000	200000
Capacity Utilization (in %)	31.70%	5.43%	4.02%	3.64%	10.20%	10.20%	10.20%
<b>Super Single Phosphate (SSP)</b>							
Total Installed Capacity (Metric tonnes)	120000	120000	120000	120000	120000	120000	120000
Capacity Utilization (in %)	85.23%	71.74%	68.21%	55.43%	83.33%	83.33%	83.33%
<b>Granulated Single Super Phosphate (GSSP)</b>							
Total Installed Capacity (Metric tonnes)	90000	90000	90000	90000	90000	90000	90000
Capacity Utilization (in %)	10.62%	24.04%	24.63%	19.84%	30.45%	30.45%	30.45%
<b>Unit II</b>							
<b>Intermediate Dyes and H-Acid</b>							
Total Installed Capacity (Metric tonnes)	-	-	-	1324	1324	1324	1324
Capacity Utilization (in %)	-	-	-	2.57%	21.15%	43.23%	57.24%
<b>Unit III</b>							
<b>Sulphuric Acid</b>							
Total Installed Capacity (Metric tonnes)	-	-	-	-	49500	49500	49500
Capacity Utilization (in %)	-	-	-	-	-	60.00%	90.00%

**PLANT & MACHINERY:-**

We have installed sufficient Plant and Machinery in all the manufacturing units for manufacturing of Single Super Phosphate, Beneficiated Rock Phosphate, Granulated Single Super Phosphate (GSSP), H-Acid and Intermediate Dyes. For details of major Plant and Machinery installed for each Product please refer to section titled "Our Business" beginning on page 91 of this Prospectus.

**COLLABORATIONS/TIE UPS/ JOINT VENTURES:-**

Except as disclosed in this Prospectus and normal course of business, we do not have any Collaboration/Tie Ups/ Joint Ventures as on date.

**EXPORT OBLIGATION:**

Our Company does not have any export obligation as on date

**SALES AND MARKETING:-**

Marketing is an important function of our organization. Our success lies in the strength of our relationship with our customer who has been associated with our Group for a long period. Also our Company has entered to a Memorandum of understanding with DCM Shriram Limited (its Unit M/s Shriram Fertilizers & Chemicals) ("Our Customer") to source and market the Single Super Phosphates (SSP) for the period of five years from April 01, 2015 and Beneficiated Rock Phosphate (BRP) are captivity consumed by the SSP plant and if any surplus will be sold out in the market and considering the same no marketing arrangements are required for BRP.

### Marketing Strategy:

We intend to focus on following marketing strategies:

1. Focus on existing markets.
2. To expand our existing distribution base
3. Continuously holding markets Trends.
4. Supply of Quality Products.
5. Fulfillment of Order Quantity.

### COMPETITION:-

SSP is one of the fertilizers which are in bulk demand in India and there are few dedicated players in this line of activity. There are certain few peer companies whose one of the products manufactured is SSP; they are manufacturing other complex fertilizers along with manufacturing SSP. We face substantial competition for our products from other manufacturers in domestic market. Our competition varies for our products and regions. Some of our major competitors are:-

- Rama Phosphates Limited
- Aries Agro Limited
- Coromandel International Limited

### SIGNIFICANT DEVELOPMENT SUBSEQUENT TO THE LAST FINANCIAL YEAR:-

In the opinion of the Board of Directors of our Company, there have not arisen any circumstances since the date of the last financial statements disclosed in this Prospectus that materially or adversely affect the operations or profitability of the Company or the Value of its assets or its ability to pay its liability within next twelve months except below changes occurred after Balance Sheet date:-

1. Our Company has constituted an Audit Committee (“Audit Committee”), Nomination and Remuneration Committee and Stakeholders Relationship Committee vide Board Resolution dated December 20, 2016, as per the applicable provisions of the Section 177 of the Companies Act, 2013 and also to comply with SEBI (Listing Obligations and Disclosure Requirements) Regulations, 2015 applicable upon listing of the Company’s Equity shares on SME platform of NSE (“NSE Emerge”).
2. We have appointed Mr. Praveen Ostwal as Chairman of the Company with effect from December 19, 2016.
3. We have appointed Mrs. Priyanka Surana as Non-Executive Independent Director of the Company with effect from December 19, 2016
4. We have approved and taken into the record the proposed offer for sale of equity shares of the Company on the meeting of the Shareholders dated December 19, 2016.
5. We have appointed Ms. Priyanka Bansal as Company Secretary of the Company with effect from December 14, 2016
6. We have approved and taken into the record the proposed offer for sale of equity shares of the Company on the meeting of the Board of Director dated December 14, 2016.

### FACTORS AFFECTING OUR FUTURE RESULTS OF OPERATIONS:-

Our results of operations could potentially be affected by the following factors amongst others:

1. Heavy dependence on Supply of Raw Material i.e. Rock Phosphate
2. Disruption in our manufacturing facilities.
3. Inability to sustain or manage our growth.
4. Failure to comply with regulations prescribed by authorities of the jurisdictions in which we operate;

5. Inability to successfully obtain registrations in a timely manner or at all;
6. General economic and business conditions in the markets in which we operate and in the local, regional and national economies;
7. Our ability to effectively manage a variety of business, legal, regulatory, economic, social and political risks associated with our operations;
8. Changes in laws and regulations relating to the industries in which we operate;
9. Effect of lack of infrastructure facilities on our business;
10. Increase in prices of Raw Material
11. Occurrence of Environmental Problems & Uninsured Losses;
12. Intensified competition in industries/sector in which we operate;
13. Our ability to successfully implement our growth strategy and expansion plans;
14. Our ability to meet our capital expenditure requirements;
15. Our ability to attract, retain and manage qualified personnel;
16. Failure to adapt to the changing technology in our industry of operation may adversely affect our business and financial condition;
17. Changes in political and social conditions in India or in countries that we may enter, the monetary and interest rate policies of India and other countries, inflation, deflation, unanticipated turbulence in interest rates, equity prices or other rates or prices;
18. Conflicts of interest with affiliated companies, the promoter group and other related parties;
19. The performance of the financial markets in India and globally;
20. Any adverse outcome in the legal proceedings in which we are involved;
21. Our ability to expand our geographical area of operation;
22. Concentration of ownership among our Promoters.

**Our Significant Accounting Policies:**

Our significant accounting policies are described in the section entitled “Financial Information of the Company” on page 157 of this Prospectus.

**Change in accounting policies in previous 3 (three) years**

Except as mentioned in chapter “Financial Information of the Company” on page 157, there has been no change in accounting policies in last 3 (three) years.

**Summary of the Results of Operations**



The following table sets forth financial data from restated profit and loss account for the period ended November 30, 2016 and financial Year ended on March 31, 2016, 2015, 2014, 2013 & 2012 the components of which are also expressed as a percentage of total income for such periods.

(Amt. in Lacs)

Particulars (For the Year ended)	30th November 2016	% of Total Income	31st March 2016	% of Total Income	31st March 2015	% of Total Income	31st March 2014	% of Total Income	31st March 2013	% of Total Income
Revenue from Sale of Product	4463.52	98.76	8907.44	98.29	7280.83	94.24	9040.40	99.52	4022.04	96.06
Other Income	56.12	1.24	155.23	1.71	444.99	5.76	43.30	0.48	165.16	3.94
<b>Total Income</b>	<b>4519.64</b>	<b>100.00</b>	<b>9062.67</b>	100.00	<b>7725.82</b>	100.00	<b>9083.70</b>	100.00	<b>4187.20</b>	100.00
<b>Expenditure:</b>										
Cost of Material Consumed	2972.93	65.78	4202.91	46.38	4357.67	56.40	6263.87	68.96	2101.88	50.20
Employee Benefits Expenses	70.59	1.56	173.44	1.91	160.44	2.08	171.33	1.89	162.31	3.88
Administrative and other Expenses	1019.28	22.55	1831.59	20.21	2245.12	29.06	2045.86	22.52	1709.39	40.82
Finance Costs	122.03	2.70	472.96	5.22	546.94	7.08	439.31	4.84	194.55	4.65
Depreciation And Amortization Expense	239.30	5.29	352.40	3.89	342.48	4.43	352.95	3.89	216.27	5.16
Changes in inventories	(487.78)	(10.79)	1523.18	16.81	(444.09)	(5.75)	(944.93)	(10.40)	(954.38)	(22.79)
<b>Total Expenses</b>	<b>3936.34</b>	<b>87.09</b>	<b>8556.48</b>	<b>94.41</b>	<b>7208.56</b>	93.30	<b>8328.38</b>	91.68	<b>3430.02</b>	81.92
Profit before exceptional and extraordinary items and tax	583.30	12.91	506.19	5.59	517.26	6.70	755.32	8.32	757.18	18.08
Exceptional/Prior Period item	0.00	0.00	0.00	0.00	0.00	0.00	0.00	0.00	0.00	0.00
<b>Profit before extraordinary items and tax</b>	<b>583.30</b>	<b>12.91</b>	<b>506.19</b>	<b>5.59</b>	<b>517.26</b>	<b>6.70</b>	<b>755.32</b>	<b>8.32</b>	<b>757.18</b>	<b>18.08</b>
Extraordinary item	0.00	0.00	0.00	0.00	0.00	0.00	0.00	0.00	0.00	0.00
<b>Profit Before Tax</b>	<b>583.30</b>	<b>12.91</b>	<b>506.19</b>	<b>5.59</b>	<b>517.26</b>	<b>6.70</b>	<b>755.32</b>	<b>8.32</b>	<b>757.18</b>	<b>18.08</b>
- Current Tax	115.42	2.55	107.34	1.18	101.69	1.32	150.18	1.65	149.56	3.57
- Deferred Tax Liability / (Asset)	76.96	1.70	93.04	1.03	118.04	1.53	104.56	1.15	(60.79)	(1.45)
- MAT Credit Entitlement	0.00	0.00	0.00	0.00	0.00	0.00	0.00	0.00	0.00	0.00
Short/(Excess) Tax adjustment of prior years	(1.47)	(0.03)	-9.49	-0.10	4.74	0.06	(3.96)	(0.04)	32.58	0.78
<b>Restated profit after tax for the period from continuing operations</b>	<b>392.39</b>	<b>8.68</b>	<b>315.30</b>	<b>3.48</b>	<b>292.79</b>	<b>3.79</b>	<b>504.54</b>	<b>5.55</b>	<b>635.83</b>	<b>15.19</b>

**Key Components of Company's Profit And Loss Statement**

**Revenue from Sale of Product:** Revenue from operations mainly consists of sale of BRP and SSP.

**Other Income:** Other income primarily comprises of Interest Income.

**Expenses:** Company's expenses consist of cost of material consumed, employee benefits expense, administration & Other Expenses, finance costs, depreciation and amortization expenses.

**Employee Benefits Expense:** Employee benefit expense includes Salaries and Wages and Staff Welfare Expenses, Contribution to ESIC & PF, Bonus to Employees and Provision for Gratuity.

**Finance Costs:** Finance cost comprises interest on Indebtedness, Bank charges.

**Depreciation and Amortization Expense:** We recognize Depreciation and Amortization expense on a Straight Line Method (SLM method) as per the rates set forth in the Companies Act, 2013/ Companies Act, 1956, as applicable.

**Administration & Other Expenses:** Other expenses include rent, electricity, freight, repairs, office maintenance exp, travelling and conveyance exp, telephone and internet exp and miscellaneous expenditure etc.

**Financial Performance Highlights for the stub period ended 30<sup>th</sup> November, 2016****Total Income:**

The company's total income during the period ended November 30<sup>th</sup>, 2016 was ₹ 4519.64 Lacs. The revenue from Sale of Products was ₹ 4463.52 Lacs which comprised 98.76% of company's total income for the stub period ended November 30<sup>th</sup>, 2016.

**Total Expenses:**

The total expenditure during the stub period ended November 30<sup>th</sup>, 2016 was ₹ 3936.34 Lacs. The total expenditure represents 87.09% of the total revenue. The total expenses are represented by Cost of material consumed, Employee Benefits Expense, Administrative and other Expenses, Finance Costs, Depreciation and Amortization Expense. The main constituent of total expenditure is Cost of material consumed, which is ₹ 2972.93 Lacs.

**Profit/ (Loss) after tax:**

The restated net profit during the stub period ended November 30<sup>th</sup>, 2016 was ₹ 392.39 Lacs representing 8.68% of the total revenue of the Company.

**COMPARISON OF THE FINANCIAL PERFORMANCE OF FISCAL 2016 WITH FISCAL 2015****Total Income:**

During the year 2015-16 the total revenue of the company increased to ₹ 9062.67 Lacs as against ₹ 7725.82 Lacs in the year 2014-15, representing an increase of 17.30% of the total revenue. This increase was mainly due to increase in sale of products

**Other Income:**

Other income of the Company for the year 2015-16 was ₹ 155.23 Lacs in comparison with ₹ 444.99 Lacs for F.Y. 2014-15.

**Total Expenses:**

The total expenditure for the year 2015-16 increased to ₹ 8556.48 Lacs from ₹ 7208.56 Lacs in year 2014-15, representing an increase of 18.70% to the previous year.

***Cost of Goods consumed:***

The Cost of Material Consumed for the year 2015-16 decreased to ₹ 4202.91 Lacs from ₹ 4357.67 Lacs, representing a decrease of 3.55% to the 2014-15.

***Employee Benefits Expense:***

The Employee Benefit Expense comprises of salaries and wages and staff welfare expenses. The said expenses increased to ₹ 173.44 Lacs during the F.Y. 2015-16 from ₹ 160.44 Lacs in the previous year 2014-15.

***Finance Costs:***

Finance cost for the year 2015-16 decreased to ₹ 472.96 Lacs as against ₹ 546.94 Lacs of the year 2014-15. This decrease in amount was due to pre payment of borrowings of the Company.

***Depreciation and Amortization Expense:***

Depreciation for the year 2015-16 stood at ₹ 352.40 Lacs calculated at SLM method as per companies Act. For the year 2014-15 the same was ₹ 342.48 Lacs.

***Administrative and other Expenses:***

Administrative and other Expenses include rent, electricity, freight, repairs, office maintenance exp, travelling and conveyance exp, telephone and internet exp and miscellaneous expenditure etc. These expenses decreased to ₹ 1831.59 Lacs for the year 2015-16 as against ₹ 2245.12 Lacs of the year 2014-15.

***Profit/ (Loss) Before Tax***

The company's profit before tax for F.Y. 2015-16 was Rs 506.19 Lacs as against ₹ 517.26 Lacs in the year 2014-15 representing a decrease of 2.14% to the previous year.

***Profit/ (Loss) After Tax***

For the year 2015-16 the profit stood at ₹ 315.30 Lacs as against the profit of ₹ 292.79 Lacs for the year 2014-15, representing an increase of 7.69% to the previous year.

**COMPARISON OF THE FINANCIAL PERFORMANCE OF FISCAL 2015 WITH FISCAL 2014*****Total Income:***

During the year 2014-15 the total revenue of the company decreased to ₹ 7725.82 Lacs as against ₹ 9083.70 Lacs in the year 2013-14, representing a decrease of 14.95% of the total revenue. This decrease was mainly due to decrease in sale of Products and decrease in other income.

***Other Income:***

Other income of the Company for the year 2014-15 was ₹ 444.99 Lacs in comparison with ₹ 43.30 Lacs for F.Y. 2013-14.

***Total Expenses:***

The total expenditure for the year 2014-15 decreased to ₹ 7208.56 Lacs from ₹ 8328.38 Lacs in year 2013-14, representing a decrease of 13.45% to the previous year. This was due to decrease in volume of business, which resulted in decrease in expenses viz. Cost of material consumed.

***Cost of Material Consumed:***

The Cost of Material Consumed for the year 2014-15 increased to ₹ 4357.67 Lacs from ₹ 6263.87 Lacs, representing a decrease of 30.43% to the previous year.

***Employee Benefits Expense:***

The Employee Benefit Expense comprises of salaries and wages and staff welfare expenses. The said expenses decrease to ₹ 160.44 Lacs during the F.Y. 2014-15 from ₹ 171.33 Lacs in the previous year 2013-14.

***Finance Costs:***

Finance cost for the year 2014-15 increased to ₹ 546.94 Lacs as against ₹ 439.31 Lacs of the year 2013-14. This increase in amount was due to increase in borrowings of the Company.

***Depreciation and Amortization Expense:***

Depreciation for the year 2014-15 stood at ₹ 342.48 Lacs calculated at SLM method as per companies Act. For the year 2013-14 the same was ₹ 352.95 Lacs.

***Administrative and other Expenses:***

Administrative and other Expenses include rent, electricity, freight, repairs, office maintenance exp, travelling and conveyance exp, telephone and internet exp and miscellaneous expenditure etc. These expenses were for the year 2014-15 increased to ₹ 2245.12 Lacs as against ₹ 2045.86 Lacs of the year 2013-14.

***Profit/ (Loss) Before Tax***

The company's profit before tax for F.Y. 2014-15 decrease to Rs 517.26 Lacs from ₹ 755.32 Lacs in the year 2013-14 representing a decrease of 31.52% compared to the previous year.

***Profit/ (Loss) After Tax***

For the year 2014-15 the profit stood at ₹ 292.79 Lacs as against the profit of ₹ 504.54 Lacs for the year 2013-14, representing a decrease of 41.97% compared to the previous year.

**COMPARISON OF THE FINANCIAL PERFORMANCE OF FISCAL 2014 WITH FISCAL 2013**

**Total Income:**

During the F.Y. 2013-14 the total income of the Company increased to ₹ 9083.70 Lacs as against previous financial year 2012-13 of ₹ 4187.20 Lacs representing an increase of 116.94%. This increase was mainly due to increase in revenue from sale of products.

**Total Expenses:**

Total expenditure for the F.Y. 2013-14 increased to ₹ 8328.38 Lacs from ₹ 3430.02 Lacs in FY 2012-13 representing an increase of 142.81%. This was due to increase in volume of business, which resulted in increase in expenses viz. Cost of material consumed, employees benefit expenses, Administrative and other Expenses and changes in inventory of Finished Goods.

**Employee benefits expense:**

Employee benefits expense increased to ₹ 171.33 Lacs in the year F.Y 2013-14 from ₹ 162.31 Lacs in FY 2012-13, representing an increase of 5.55%. This was also due to increase in business activities in the Company.

**Finance Costs:**

Finance costs increased to ₹ 439.31 Lacs in F.Y 2013-14 as compared to F.Y 2012-13 in which it was ₹ 194.55 Lacs

**Depreciation and amortization expense:**

Depreciation and amortization expense increased in FY 2013-14 to ₹ 352.95 Lacs from ₹ 216.27 Lacs compared to previous year FY 2012-13.

**Administrative and other Expenses:**

Other expenses for the F.Y 2013-14 increased to ₹ 2045.86 Lacs whereas it was ₹ 1709.39 Lacs in previous F.Y. 2012-13.

**Net Profit before tax:**

Net Profit before tax for the F.Y 2013-14 decreased to ₹ 755.32 Lacs as against ₹ 757.18 Lacs for the previous year 2012-13 representing a decrease of 0.25% compared to the previous year.

**Profit after tax:**

The Restated profit after tax for the F.Y 2013-14 decreased to ₹ 504.54 Lacs as against ₹ 635.83 Lacs in the previous year 2012-13 representing a decrease of 20.65% compared to the previous year.

**Information required as per Item (2) (IX) (E) (5) of Part A of Schedule VIII to the SEBI Regulations:**

**An analysis of reasons for the changes in significant items of income and expenditure is given hereunder:**

***1. Unusual or infrequent events or transactions***

There has not been any unusual trend on account of our business activity. There are no Unusual or infrequent events or transactions in our Company. The transactions are as per usual business operations.

***2. Significant economic changes that materially affected or are likely to affect income from continuing operations.***

Except for any change in economic policy affecting the agriculture and farming sector in India, there are no other significant economic changes that may materially affect or likely to affect income from continuing operations.

***3. Known trends or uncertainties that have had or are expected to have a material adverse impact on sales, revenue or income from continuing operations.***

Apart from the risks as disclosed under Section "Risk Factors" beginning on page 16 in the Prospectus, in our opinion there are no other known trends or uncertainties that have had or are expected to have a material adverse impact on revenue or income from continuing operations.

***4. Future changes in relationship between costs and revenues***

Our Company's future costs and revenues will be determined by demand/supply situation in agricultural sector, government policies, monsoon, climatic factors and prices quoted by our suppliers.

***5. Increases in net sales or revenue and Introduction of new products or services or increased sales prices***

Increases in revenues are by and large linked to increases in volume of our business.

**6. Status of any publicly announced New Products or Business Segment**

Since our Company has not announced any new Product so not Applicable.

**7. Seasonality of business**

The demand of our product and business of our company is directly influenced by the agricultural crop season.

**8. Dependence on few customers/ clients**

The percentage of contribution of our Company's Top Customers/Clients for the year ended November 30<sup>th</sup>, 2016 is as follows:

**Our Major Customers/ Clients for the year ended November 30<sup>th</sup>, 2016**

Name of the Clients	Amount (₹ in Lacs)	As % of total turnover
Shriram Fertilizers & Chemical	4424.58	100.00
<b>Total</b>	<b>4424.58</b>	<b>100.00</b>

*\*The above value is inclusive of all applicable taxes and incidental expenses.*

**Our Major Suppliers of Raw material for the year ended November 30<sup>th</sup>, 2016**

Name of Supplier	Amount (₹ in Lacs)	As % of total Purchase
Gulf Fert International FZE	375.90	11.89
Madhya Bharat Agro Product Ltd – II (BRP)	281.65	8.91
Sunivera Impex DWC LLC	263.75	8.34
Transcom DMCC	238.53	7.54
Rescom Mineral Trading FZE	199.01	6.29
B. Roshan Lal Chemicals Pvt. Ltd.	197.16	6.24
Khajuraho Stones (India) Pvt Ltd	151.04	4.78
Hindustan Zinc Ltd	126.92	4.01
Paramount Pharma	105.00	3.32
RSMM Ltd.	47.03	1.49
<b>Total</b>	<b>1985.98</b>	<b>62.81</b>

*\*The above value is inclusive of all applicable taxes and incidental expenses.*

**9. Competitive conditions**

Competitive conditions are as described under the Chapters "Industry Overview" and "Our Business" beginning on pages 79 and 91, respectively of the Prospectus.

**10. Details of material developments after the date of last balance sheet i.e. November 30<sup>th</sup>, 2016**

Except as disclosed in this Prospectus, no circumstances have arisen since the date of last financial statement until the date of filing the Prospectus, which materially and adversely affect or are likely to affect the operations or profitability of our Company, or value of its assets, or its ability to pay its liability within next twelve months. There is no subsequent development after the date of the Auditor's Report, which will have a material impact on the reserves, profits, earnings per share and book value of the Equity Shares of the Company.

## SECTION VI - LEGAL AND OTHER INFORMATION

### OUTSTANDING LITIGATION AND MATERIAL DEVELOPEMENTS

Except as described below, there are no outstanding litigations, suits, civil or criminal prosecutions, proceedings before any judicial, quasi-judicial, arbitral or administrative tribunals, including pending proceedings for violation of statutory regulations or alleging criminal or economic offences or tax liabilities or any other offences (including past cases where penalties may or may not have been awarded and irrespective of whether they are specified under paragraph (i) of Part I of Schedule XIII of the Companies Act ) against our Company, Promoter, Group Companies and Directors as of the date of this Prospectus that would have a material adverse effect on our business. There are no defaults, non-payments or overdue of statutory liabilities, institutional/ bank dues and dues payable to holders of debentures or fixed deposits and arrears of cumulative preference shares that would have a material adverse effect on our business.

Further, Our Company has a policy for identification of Material Litigation in terms of the SEBI (ICDR) Regulations, 2009 as amended for disclosure of all pending litigation involving our Company, holding, Directors, Promoters and Group Companies, other than criminal proceedings and statutory or regulatory actions, would be considered 'material' if the monetary amount of claim by or against the entity or person in any such pending proceeding is in excess of Rs. 1,00,000/- and where the amount is not quantifiable, such pending cases are material from the perspective of the company's business, operations, prospects or reputation.

The Company has policy for identification of material outstanding dues to creditors in terms of the SEBI (ICDR) Regulations, 2009 as amended for creditors where outstanding dues to any one of them exceeds Rs. 1,00,000/- .

#### **PART 1: CONTINGENT LIABILITIES OF THE COMPANY**

Particulars	Amount (in Lacs)
Indirect Tax demand	0.42
<b>Total</b>	

#### **PART 2: LITIGATION RELATING TO THE COMPANY**

##### **A. CASES FILED AGAINST THE COMPANY**

##### **1) Litigation involving Criminal Laws**

NIL

##### **2) Litigation Involving Actions by Statutory/Regulatory Authorities**

NIL

##### **3) Litigation involving Tax Liability**

##### **Indirect Tax:-**

Our Company has received an notice of demand under Form 28 of Madhya Pradesh Vat Act, 2002 from Commercial Taxes Department, Madhya Pradesh for total tax, penalty and interest includes Rs. 8,86,585/- payable by company for assessment year 2014-15. Further the company has granted refund of Rs. 8,44,821/- under Madhya Pradesh VAT and balance of Rs. 41764/- is pending for payment. The matter is still pending with concerned authority.

##### **Direct Tax-NIL**

##### **4) Other Pending Litigation**

Case no. 7/2016- Gaurav V/s M/s Krishna Phoschem Limited

Our Company has received a Notice from Office of the Labour Court, Ratlam as per Case 07/2016 dated August 06, 2016 under Payment of Wages Act, 1936 for claim against our company was presented by the accused. The notice was issued to present in office of labour court on August 24, 2016. The matter is still pending with concerned authority.

**B. CASES FILED BY THE COMPANY****1) Litigation involving Criminal Laws**

NIL

**2) Litigation Involving Actions by Statutory/Regulatory Authorities**

NIL

**3) Litigation involving Tax Liability**

Direct Tax – NIL

Indirect Tax - NIL

**4) Other Pending Litigation**

NIL

**PART 3: LITIGATION RELATING TO THE DIRECTORS OTHER THAN THE PROMOTERS OF THE COMPANY****A. LITIGATION AGAINST THE DIRECTORS****1) Litigation involving Criminal Laws**

NIL

**2) Litigation Involving Actions by Statutory/Regulatory Authorities**

NIL

**3) Litigation involving Tax Liability**

Direct Tax – NIL

Indirect Tax - NIL

**4) Other Pending Litigation**

NIL

**B. LITIGATION FILED BY THE DIRECTORS****1) Litigation involving Criminal Laws**

NIL

**2) Litigation Involving Actions by Statutory/Regulatory Authorities**

NIL



**3) Litigation involving Tax Liability**

Direct Tax – NIL

Indirect Tax - NIL

**4) Other Pending Litigation**

NIL

**PART 4: LITIGATION RELATING TO THE PROMOTER**

**A. M/s Seasons Agro Chem India Private Limited**

**A. LITIGATION AGAINST THE PROMOTER**

**1) Litigation involving Criminal Laws**

NIL

**2) Litigation Involving Actions by Statutory/Regulatory Authorities**

NIL

**3) Litigation involving Tax Liability**

**Direct Tax**

In respect of the Financial Year 2014-15, the Promoter Seasons Agro Chem India Pvt. Ltd. had received a notice under Section 142(1) of the Income Tax Act, 1961 for the limited scrutiny selected under Computer Assisted Scrutiny selection (CASS) for the period -01/04/2014 to 31/03/2015 dated 12/04/2016. Further proceedings are in process with the concerned Authorities.

**Indirect Tax - NIL**

**4) Other Pending Litigation**

NIL

**B. LITIGATION FILED BY THE PROMOTER**

**1) Litigation involving Criminal Laws**

*(a) Case No. 980/13- Seasons Agro Chem Pvt Ltd V/s Jugal Agrawal*

M/s Seasons Agro Chem India Private Limited filed a complaint under Section 138/142 of the Negotiable Instruments Act 1881 against M/s Jugal Sales, through its proprietor Mr. Jugal Agarwal before the Additional District Magistrate (N.I Act) Court No. 1, Bhilwara for non receipt of payment against supply of goods to M/s Jugal Sales. The complaint was duly registered at 980/13. The claim was for an amount of Rs 80,000/-. Matter is subjudice before the court.

*(b) Case No. 981/13- Seasons Agro Chem Pvt Ltd V/s Jugal Agrawal*

M/s Seasons Agro Chem India Private Limited filed a complaint under Section 138/142 of the Negotiable Instruments Act 1881 against M/s Jugal Sales, through its proprietor Mr. Jugal Agarwal before the Additional District Magistrate (N.I Act) Court No. 1, Bhilwara for non receipt of payment against supply of goods to M/s Jugal Sales. The complaint was duly registered at 981/13. The claim was for an amount of Rs 50,000/-. Matter is subjudice before the court.

**2) Litigation Involving Actions by Statutory/Regulatory Authorities**

NIL

**3) Litigation involving Tax Liability****Direct Tax – NIL****Indirect Tax - NIL****4) Other Pending Litigation**

NIL

**B. M/s Ostwal Phoschem (India) Limited (formally known as Tedco Granite Limited)****A. LITIGATION AGAINST THE PROMOTER****1) Litigation involving Criminal Laws**

NIL

**2) Litigation Involving Actions by Statutory/Regulatory Authorities****Environmental Law***Case No. 09/04- Government V/s Gram Panchayat Vagarh*

- (a) Sitaram Ahir filed a complaint under section 133 of Code of Criminal Procedure, 1973 against Ostwal Phoschem (India) Limited (Formerly known as Tedco Granite Limited) before Sub-Divisional Magistrate, Bhilwara on the grounds that Smoke emitted from the factory of Ostwal Phoschem (India) Limited (Formerly known as Tedco Granite Limited) contains chemicals which is harmful for the people, animals and plants around the factory and thus the factory should be closed. The complaint was duly registered at 09/04. The amount involved is undetermined. Matter is subjudice.

**3) Litigation involving Tax Liability****Direct Tax**

In respect of the Financial Year 2013-14, the Promoter Ostwal Phoschem (India) Limited had received a notice dated 01/09/2015 under Section 143(2) of the Income Tax Act, 1961 for the scrutiny of the books of accounts and other documents in support of the return for the period -01/04/2013 to 31/03/2014. Further proceedings are still pending with the concerned Authorities.

**Indirect Tax - NIL****4) Other Pending Litigation**

- (a) *Case No. 329/99- Rajasthan Government V/s M/S Mohan Lal Suva Lal Siroya and others*

State through Fertilizer Inspector Officer, Kapasan filed a complaint under Clause 19 of F.C.O, 1985 and Section 3/7 of Essential Commodities Act, 1955 against M/S Mohan Lal Suva Lal Siroya, Mr. M K Ostwal (Managing Director- Tedco Granite Limited), Mr. P K Pandey, M/S Chandmal Arun Kumar Jain on the grounds that samples of fertilizers taken for analysis at laboratory were found to be nonstandard. . The complaint was registered at case no. 329/99. The amount involved in the case is undetermined. Matter has been finalized with concerned authority. However copy of final order is awaited.

(b) *Case No. 330/99- Rajasthan Government V/s Shri Maheshwari Fertilizers and others*

State through Fertilizer Inspector Officer, Kapasan filed a complaint under Clause 19 of F.C.O, 1985 and Section 3/7 of Essential Commodities Act, 1955 against Shri Maheshwari Fertilizers, Mr. M K Ostwal (Managing Director- Tedco Granite Limited), Shri P K Pandey, M/S Chandmal Arun Kumar Jain on the grounds that samples of fertilizers taken for analysis at laboratory were found to be nonstandard. The complaint was registered at case no. 330/99. The amount involved in the case is undetermined. Matter has been finalized with concerned authority. However copy of final order is awaited.

(c) *Case No. 357/99- Rajasthan Government V/s M/S Duggar Brothers and others*

State through Fertilizer Inspector Officer, Kapasan filed a complaint under Clause 19 of F.C.O, 1985 and Section 3/7 of Essential Commodities Act, 1955 against M/S Duggar Brothers, M/s Chandmal Arun Kumar Jain, Tedco Granite Limited, Surya Fertilizers on the grounds that samples of fertilizers taken for analysis at laboratory were found to be nonstandard. The complaint was registered at case no. 357/99. The amount involved in the case is undetermined. Matter has been finalized with concerned authority. However copy of final order is awaited.

(d) *Case No. 358/99- Rajasthan Government V/s M/S Kanahiya Lal Parasmal Sahlot and others*

State through Fertilizer Inspector Officer, Kapasan filed a complaint under Clause 19 of F.C.O, 1985 and Section 3/7 of Essential Commodities Act, 1955 against M/S Kanahiya Lal Parasmal Sahlot, Shri Chandmal Arun Kumar Jain, Tedco Granite Limited on the grounds that samples of fertilizers taken for analysis at laboratory were found to be nonstandard. The case was registered at case no. 358/1999. The amount involved in the case is undetermined. Matter has been finalized with concerned authority. However copy of final order is awaited.

(e) *Case No. 288/00- Rajasthan Government V/s Shri Kalyasn Sahay and others*

State through Fertilizer Inspector Officer, Prakash Chandra Sharma, Dausa filed a complaint under Clause 19 of F.C.O, 1985 and Section 3/7 of Essential Commodities Act, 1955 against Shri Kalyan Sahay, Shri Basan Kumar Momodia, Shri Pramod Pandey- Officer of Tedco Granite Limited on the grounds that all the above defendant are guilty of producing, distributing and selling nonstandard fertilizer and are therefore punishable. The complaint was registered at case no. 288/2000. The amount involved in the case is undetermined. The matter is pending before concerned authority.

(f) *Case No. 398/00- Rajasthan Government V/s Shri Om Prakash Agarwal and others*

State through Fertilizer Inspector Officer, Nathulal Tardiya, Jaipur filed a complaint under Clause 19 of F.C.O, 1985 and Section 3/7 of Essential Commodities Act, 1955 against Shri Om Prakash Agarwal, M/s Agarwal Agency Khad, Sadhna Phosphate and Chemicals Limited, Shri Vinod Kumar Mishra- Officer of Sadhna Phosphate and Chemicals Limited, Shri Suraj Narayan, Shri Pramod Pandey- Officer of M/s Tedco Granite Limited, Shri Shambudayal- M/s B.K. Fertilisers on the grounds that all the above defendant are guilty of producing, distributing and selling nonstandard fertilizer and are therefore punishable. The complaint was registered at case no. 398/00. The amount involved in the case is undetermined. . Matter is subjudice.

(g) *Case No. 266/07- Rajasthan Government V/s Shri Abhay Kumar Gattani and others*

State through Agriculture Officer (GEN.), Chittorgarh filed a complaint under clause 19 of F.C.O, 1985 and under section 7 (1) (a) (II) of Essential Commodities Act, 1955 against Shri Abhay Kumar Gattani, Mr. Pramod Pandey (Manager Operation – Tedco Granite Ltd.), Ms. Chandmal Arun Kumar on the grounds that all the above defendant are guilty of producing, distributing and selling nonstandard fertilizer and are therefore punishable. The complaint was duly registered at 266/2007. The amount involved in the case is undetermined. Matter is subjudice. The matter is pending before concerned authority.

(h) *Case No. 63/04- Rajasthan Government V/s Krishi Seva Kendra, Ravatbhata and others*

State through Fertilizer Inspector Officer, Jagphool Singh Meena, Chittorgarh filed a complaint under Clause 19 of F.C.O, 1985 and Section 3/7 of Essential Commodities Act, 1955 against Krishi Seva Kendra, Ravatbhata, Shri Janki Lal, Md. Hussain- Tedco Granite Limited on the grounds that all the above defendant are guilty of producing, distributing and selling nonstandard fertilizer and are therefore punishable. The complaint was registered at case no. 63/04. The amount involved in the case is undetermined. Matter is subjudice.

(i) *Case No. 06/00- Rajasthan Government V/s Shri Vijay Singh Lodha and others*

State through Fertilizer Inspector Officer, Chittorgarh filed a complaint under Clause 19 of F.C.O, 1985 and Section 3/7 of Essential Commodities Act, 1955 against Shri Vijay Singh Lodha, Lodha Brothers, Shri Pramod Pandey, Tedco Granite Limited, Shri Ashok Kumar on the grounds that all the above defendant are guilty of producing, distributing and selling nonstandard fertilizer and are therefore punishable. The Complaint was duly registered at case no. 06/00. The amount involved in the case is undetermined. Matter is subjudice.

(j) *Case No. 07/00- Rajasthan Government V/s Shri Jagdish Prasad and others*

State through Fertilizer Inspector Officer, Chittorgarh filed a complaint under Clause 19 of F.C.O, 1985 and Section 3/7 of Essential Commodities Act, 1955 against Shri Jagdish Prasad, M/S Jagdish Prasad and Sons, Shri Pramod Pandey, Tedco Granite Limited, Shri Ashok Kumar, Shri Ganesh Kumar on the grounds that all the above defendant are guilty of producing, distributing and selling nonstandard fertilizer and are therefore punishable. The Complaint was duly registered at case no. 07/2000. The amount involved in the case is undetermined. Matter is subjudice.

(k) *Case No. 254/07- Office of Fertilizer Inspector V/s M/S Hindustan Trading Company and others*

State through Fertilizer Inspector Officer, Kailash Chand Meena, Sawai Madhopur filed a complaint under clause 19 (1) (a) of F.C.O, 1985 and under section 3/ 7 of Essential Commodities Act, 1955 against M/S Hindustan Trading Company, M/S Kedawat & Company, Tedco Granite Limited and Shri Ram Fertilisers and Chemicals Limited on the grounds that all the above defendant are guilty of producing, distributing and selling nonstandard fertilizer and are furnished show cause notice for the same. The complaint was duly registered at case no. 254/07. The amount involved in the case is undetermined. Matter is subjudice. Next date of hearing is February 09, 2017.

(l) *Case No. 255/07- Office of Fertilizer Inspector V/s M/S Goyal Enterprises and others*

State through Fertilizer Inspector Officer, Kailash Chand Meena, Sawai Madhopur filed a complaint under clause 19 (1) (a) of F.C.O, 1985 and under section 3/ 7 of Essential Commodities Act, 1955 against M/S Goyal Enterprises, Shri Hanuman Prasad Goyal (Proprietor, M/S Goyal Enterprises), M/S Kedawat & Company, Tedco Granite Limited and M/s Shri Ram Fertilisers and Chemicals Limited, the complaint was duly registered at case no 255/2007. The amount involved in the case is undetermined. Matter is subjudice. Next date of hearing is February 09, 2017.

(m) *Case No. 167/02- Rajasthan Government V/s Datra Gram Seva Sahkari Samiti Limited and others*

State through Fertilizer Inspector Officer, Bhilwara, Rameshwar Prasad Kumawat, filed a complaint under clause 19 (1) (a) & (b) of F.C.O, 1985 and under section 3/ 7 of Essential Commodities Act, 1955 against Datra Gram Seva Sahkari Samiti Limited, Shri Devilal Kumawat, Shri Shantilal/ Shankar Tailor, M/S Tedco Granite Limited, Rajasthan State Mines and Minerals, Surya Fertilisers and Chemicals Limited. The complaint was duly registered at case no. 167/2002. The amount involved in the case is undetermined. Matter has been finalized with concerned authority. However copy of final order is awaited.

(n) *Case No. 265/02- Rajasthan Government V/s M/S Tedco Granite Limited*

State through Fertilizer Inspector Officer, Rameshwar Prasad Kumawat, Bhilwara filed a complaint under clause 19 (1) of F.C.O, 1985 and under section 3/7 of Essential Commodities Act, 1955 against M/S Tedco Granite Limited. The

complaint was duly registered at case no. 265/2002. The amount involved in the case is undetermined. Matter has been finalized with concerned authority. However copy of final order is awaited.

## **B. LITIGATION FILED BY THE PROMOTER**

### **1) Litigation involving Civil Laws**

### **2) Litigation Involving Actions by Statutory/Regulatory Authorities**

NIL

### **3) Litigation involving Tax Liability**

**Direct Tax – NIL**

**Indirect Tax - NIL**

### **4) Other Pending Litigation**

(a) *Case No. 4353/2009- Tedco Granite Limited V/s State of Rajasthan and ORS.*

Ostwal Phoschem (India) Limited (formerly known as Tedco Granite Limited) has filed a writ Petition (Civil) registered with High Court of Rajasthan in Civil Writ 4353/2009 under Indirect tax-levy of cess from retrospective effect on the exploration and purchase of rock phosphate by the company. The amount involved Rs. 1,46,84,239/- Matter is subjudice.

(b) *Case No. 70/2015 and 71/2015 - M/s Tedco Granite Limited V/s M/s New India Transport Company*

Ostwal Phoschem (India) Limited (formerly known as Tedco Granite Limited) had filed a S.B. Civil second Appeal under section 100 CPC registered as case no. 70/2015 and 71/2015 with High Court of Rajasthan against the judgment and decree dated 06/12/2014 passed by Shri Hariom Sharma Attrim RHJS, Addtl. District judge, Udaipur in Civil first Appeal No. 01/2009, for recovery of security deposit money paid by M/s New India Transport Company (Original Plaintiff). The Appellant has refused to return the security deposit due to non-receipt of payment of the raw material purchased against the above deposit and has therefore filed the above captioned second appeal. The amount involved is Rs. 50,000 (Rupees Fifty thousand only). Date of order was 19/08/2016 and It is decided by the HC that the second appeal is not maintainable and directed to register the appeal as writ petition.

## **PART 5: LITIGATION RELATING TO THE GROUP COMPANIES**

### **A. M/s Seasons International Private Limited**

#### **A. LITIGATION AGAINST THE GROUP COMPANIES**

##### **1) Litigation involving Criminal Laws**

NIL

##### **2) Litigation Involving Actions by Statutory/Regulatory Authorities**

NIL

##### **3) Litigation involving Tax Liability**

##### **Direct Tax**

In respect of the Financial Year 2013-14, the group Company Seasons International Pvt. Ltd. had received a notice dated 01/09/2015 under Section 143(2) of the Income Tax Act, 1961 for the scrutiny of the books of accounts and other documents in support of the return for the period -01/04/2013 to 31/03/2014. Further proceedings are still pending with the concerned Authorities.

**Indirect Tax - NIL****4) Other Pending Litigation**

*Case No. RCS-B/12/2014 - M/s Chopra Foods V/s Seasons International Private Limited*

M/s Chopra Foods & spices, through its proprietor Mr. Gaindmal Chopra, had filed a Money Recovery Suit bearing No. RCS-B/12/2014 in the Court of XX Civil Judge Class II, District Court, Indore against M/s Seasons International Private Limited, for the amount of Rs 1,29,625/-. The matter is pending before concerned authority for next hearing to be held on February 15, 2017.

**B. LITIGATION FILED BY THE GROUP COMPANIES****1) Litigation involving Criminal Laws**

NIL

**2) Litigation Involving Actions by Statutory/Regulatory Authorities****Consumer Law**

(a) *Case No. 120/2013 - M/s Seasons International Private Limited V/s Oriental Insurance Company Limited*

M/s Seasons International Private Limited filed a complaint under Section 12 of the Consumer Protection Act against Oriental Insurance Company Limited before the District Consumer Forum, Bhilwara. Our group company has taken insurance for exports of goods and the goods received by party was returned as defected goods. The complaint was duly registered vide case no. 120/2013 for nonpayment of insurance amount on goods rejected by party. The claim was for an amount of Rs 7,13,000/- .Matter is subjudice before the court.

(b) *Case No. 122/2013 - M/s Seasons International Private Limited V/s Oriental Insurance Company Limited*

M/s Seasons International Private Limited filed a complaint under Section 12 of the Consumer Protection Act against Oriental Insurance Company Limited before the District Consumer Forum, Bhilwara. Our group company has taken insurance for exports of goods and the goods received by party was returned as defected goods. The complaint was duly registered vide case no. 122/2013 for nonpayment of insurance amount on goods rejected by party. The claim was for an amount of Rs 12,67,898/-. Matter is subjudice before the court.

**3) Litigation involving Tax Liability**

**Direct Tax – NIL**

**Indirect Tax - NIL**

**4) Other Pending Litigation**

NIL

**B. M/s Madhya Bharat Agro Products Limited****A. LITIGATION AGAINST THE GROUP COMPANIES****1) Litigation involving Criminal Laws**

NIL

**2) Litigation Involving Actions by Statutory/Regulatory Authorities**

NIL

**3) Litigation involving Tax Liability****Direct Tax**

In respect of the Financial Year 2014-15, the Company had received a notice under Section 143(2) of the Income Tax Act, 1961 for the scrutiny of the books of accounts and other documents in support of the return for the period -01/04/2014 to 31/03/2015. Further proceedings are still pending with the concerned Authorities.

**Indirect Tax - NIL****4) Other Pending Litigation**

State through Agriculture Officer (GEN.), Kota, Dist Bilaspur filed a complaint under clause 19 of F.C.O, 1985 and under section 7 (1) (a) (II) of Essential Commodities Act, 1955 against Shri Raghuvansh Singh and Suman Khela (Regional Manager- Madhya Bharat Agro Products Limited), The complaint was duly registered at the court of ADJ 1, Kota. The amount involved in the case is undetermined. The matter is subjudice.

**B. LITIGATION FILED BY THE GROUP COMPANIES****1) Litigation involving Criminal Laws**

NIL

**2) Litigation Involving Actions by Statutory/Regulatory Authorities****3) Litigation involving Tax Liability****Direct Tax – NIL****Indirect Tax - NIL****4) Other Pending Litigation**

*Case No. 12467/2012 - Madhya Bharat Agro Products Limited V/s State of Rajasthan & Ors.*

Madhya Bharat Agro Products Limited has filed a Special Leave Petition (Civil) CC registered as 12467/2012 with Supreme Court of India against the order dated 12.10.2011 passed by High Court of Rajasthan in DB Civil Writ 4355/2009 under Indirect tax-levy of cess from retrospective effect on the exploration and purchase of rock phosphate by the company. The amount involved is Rs. 47,18,414/- (Rupees forty seven lakh eighteen thousand four hundred and fourteen only) plus interest. Matter is subjudice.

**C. Nirmala Real Infrastructure Private Limited****A. LITIGATION AGAINST THE GROUP COMPANIES****1) Litigation involving Criminal Laws**

NIL

**2) Litigation Involving Actions by Statutory/Regulatory Authorities**

NIL

**3) Litigation involving Tax Liability****Direct Tax**

In respect of the Financial Year 2014-15, the Promoter group company Nirmala Real Infrastructure Private Limited had received a notice dated 18/09/2015 under Section 143(2) of the Income Tax Act, 1961 for the scrutiny of the books of accounts and other documents in support of the return for the period -01/04/2013 to 31/03/2014. Further proceedings are still pending with the concerned Authorities.

**Indirect Tax - NIL**

**4) Other Pending Litigation**

(a) *Case No. 80/2013 - Shri Parikshit Namdhar V/s Nirmala Real Infrastructure Private Limited & others*

Shri Parikshit Namdhar S/o Shri Ravindra Namdhar filed a civil suit under Order 39 Rule 1 and 2 and under Section 151 of Code of Civil Procedure 1908 bearing case no. 80/2013 in the court of Civil judge, Bhilwara against Nirmala Real Infrastructure Private Limited & others, for unauthorized construction by not following the order of court. Matter is subjudice before the court. Next date of hearing is March 07, 2017.

(b) *Case No. 99/2013 - Shri Parikshit Namdhar V/s Nirmala Real Infrastructure Private Limited & others*

Parikshit Namdhar S/o Shri Ravindra Namdhar filed a civil suit under Order 7, Rule 1 and 2 of Code of Civil Procedure 1908 bearing case no. 99/2013 in the court of Civil judge, Bhilwara, against Nirmala Real Infrastructure Private Limited, for extending the unauthorized construction of Complex in the name of Bhilwara Trade Centre and thereby effecting the Right of Easement of the shops belonging to Plaintiff. Matter is subjudice before the court. Next date of hearing is March 07, 2017.

**B. LITIGATION FILED BY THE GROUP COMPANIES**

**1) Litigation involving Criminal Laws**

NIL

**2) Litigation Involving Actions by Statutory/Regulatory Authorities**

**3) Litigation involving Tax Liability**

**Direct Tax – NIL**

**Indirect Tax - NIL**

**4) Other Pending Litigation**

NIL

**D. RV Spinners Private Limited**

**A. LITIGATION AGAINST THE GROUP COMPANIES**

**1) Litigation involving Criminal Laws**

NIL

**2) Litigation Involving Actions by Statutory/Regulatory Authorities**

NIL

**3) Litigation involving Tax Liability**

**Direct Tax - NIL**



Indirect Tax - NIL

4) **Other Pending Litigation**

NIL

**B. LITIGATION FILED BY THE GROUP COMPANIES**

1) **Litigation involving Criminal Laws**

NIL

2) **Litigation Involving Actions by Statutory/Regulatory Authorities**

3) **Litigation involving Tax Liability**

Direct Tax – NIL

Indirect Tax - NIL

4) **Other Pending Litigation**

NIL

**E. Destiny Exim Private Limited**

**A. LITIGATION AGAINST THE GROUP COMPANIES**

1) **Litigation involving Criminal Laws**

NIL

2) **Litigation Involving Actions by Statutory/Regulatory Authorities**

NIL

3) **Litigation involving Tax Liability**

Direct Tax - NIL

Indirect Tax - NIL

4) **Other Pending Litigation**

NIL

**B. LITIGATION FILED BY THE GROUP COMPANIES**

1) **Litigation involving Criminal Laws**

NIL

2) **Litigation Involving Actions by Statutory/Regulatory Authorities**

NIL

**3) Litigation involving Tax Liability**

Direct Tax – NIL

Indirect Tax - NIL

**4) Other Pending Litigation**

NIL

**F. Duggal Tex Private Limited**

**A. LITIGATION AGAINST THE GROUP COMPANIES**

**1) Litigation involving Criminal Laws**

NIL

**2) Litigation Involving Actions by Statutory/Regulatory Authorities**

NIL

**3) Litigation involving Tax Liability**

Direct Tax - NIL

Indirect Tax - NIL

**4) Other Pending Litigation**

NIL

**B. LITIGATION FILED BY THE GROUP COMPANIES**

**1) Litigation involving Criminal Laws**

NIL

**2) Litigation Involving Actions by Statutory/Regulatory Authorities**

**3) Litigation involving Tax Liability**

Direct Tax – NIL

Indirect Tax - NIL

**4) Other Pending Litigation**

NIL

**G. Alovera Tradelink Private Limited**

**A. LITIGATION AGAINST THE GROUP COMPANIES**

**1) Litigation involving Criminal Laws**

NIL

**2) Litigation Involving Actions by Statutory/Regulatory Authorities**

NIL

**3) Litigation involving Tax Liability**

**Direct Tax - NIL**

**Indirect Tax - NIL**

**4) Other Pending Litigation**

NIL

**B. LITIGATION FILED BY THE GROUP COMPANIES**

**1) Litigation involving Criminal Laws**

NIL

**2) Litigation Involving Actions by Statutory/Regulatory Authorities**

**3) Litigation involving Tax Liability**

**Direct Tax – NIL**

**Indirect Tax - NIL**

**4) Other Pending Litigation**

NIL

**H. Kolaveri Textiles Private Limited**

**A. LITIGATION AGAINST THE GROUP COMPANIES**

**1) Litigation involving Criminal Laws**

NIL

**2) Litigation Involving Actions by Statutory/Regulatory Authorities**

NIL

**3) Litigation involving Tax Liability**

**Direct Tax - NIL**

**Indirect Tax - NIL**

**4) Other Pending Litigation**

NIL

**B. LITIGATION FILED BY THE GROUP COMPANIES**

**1) Litigation involving Criminal Laws**

NIL

**2) Litigation Involving Actions by Statutory/Regulatory Authorities**

**3) Litigation involving Tax Liability**

**Direct Tax – NIL**

**Indirect Tax - NIL**

**4) Other Pending Litigation**

NIL

**I. Archid Products Private Limited**

**A. LITIGATION AGAINST THE GROUP COMPANIES**

**1) Litigation involving Criminal Laws**

NIL

**2) Litigation Involving Actions by Statutory/Regulatory Authorities**

NIL

**3) Litigation involving Tax Liability**

**Direct Tax - NIL**

**Indirect Tax - NIL**

**4) Other Pending Litigation**

NIL

**B. LITIGATION FILED BY THE GROUP COMPANIES**

**1) Litigation involving Criminal Laws**

NIL

**2) Litigation Involving Actions by Statutory/Regulatory Authorities**

NIL

**3) Litigation involving Tax Liability**

**Direct Tax – NIL**

**Indirect Tax - NIL**

**4) Other Pending Litigation**

NIL

**J. Dove Creations Private Limited****A. LITIGATION AGAINST THE GROUP COMPANIES****1) Litigation involving Criminal Laws**

NIL

**2) Litigation Involving Actions by Statutory/Regulatory Authorities**

NIL

**3) Litigation involving Tax Liability**

Direct Tax - NIL

Indirect Tax - NIL

**4) Other Pending Litigation**

NIL

**B. LITIGATION FILED BY THE GROUP COMPANIES****1) Litigation involving Criminal Laws**

NIL

**2) Litigation Involving Actions by Statutory/Regulatory Authorities****3) Litigation involving Tax Liability**

Direct Tax – NIL

Indirect Tax - NIL

**4) Other Pending Litigation**

NIL

**K. Paneri Textiles Private Limited****A. LITIGATION AGAINST THE GROUP COMPANIES****1) Litigation involving Criminal Laws**

NIL

**2) Litigation Involving Actions by Statutory/Regulatory Authorities**

NIL

**3) Litigation involving Tax Liability**

Direct Tax - NIL

Indirect Tax - NIL

**4) Other Pending Litigation**

NIL

**B. LITIGATION FILED BY THE GROUP COMPANIES**

**1) Litigation involving Criminal Laws**

NIL

**2) Litigation Involving Actions by Statutory/Regulatory Authorities**

**3) Litigation involving Tax Liability**

Direct Tax – NIL

Indirect Tax - NIL

**4) Other Pending Litigation**

NIL

**L. Chunri Prints Private Limited**

**A. LITIGATION AGAINST THE GROUP COMPANIES**

**1) Litigation involving Criminal Laws**

NIL

**2) Litigation Involving Actions by Statutory/Regulatory Authorities**

NIL

**3) Litigation involving Tax Liability**

Direct Tax - NIL

Indirect Tax - NIL

**4) Other Pending Litigation**

NIL

**B. LITIGATION FILED BY THE GROUP COMPANIES**

**1) Litigation involving Criminal Laws**

NIL

**2) Litigation Involving Actions by Statutory/Regulatory Authorities**

NIL

**3) Litigation involving Tax Liability**

Direct Tax – NIL  
 Indirect Tax - NIL

**4) Other Pending Litigation**

NIL

**PART 6: AMOUNTS OWED TO SMALL SCALE UNDERTAKINGS AND OTHER CREDITORS**

There are no disputes with such entities in relation to payments to be made to our Creditors. The details pertaining to amounts due towards such creditors are available on the website of our Company.

Below are the details of the Creditors where outstanding amount as on 30.11.2016:-

Name	Balance as on 30.11.2016 (in Lacs)
Total Outstanding dues to Micro and Small & Medium Enterprises	--
Total Outstanding dues to Creditors other than Micro and Small & Medium Enterprises	722.53

**PART 7: MATERIAL DEVELOPMENTS OCCURRING AFTER LAST BALANCE SHEET DATE**

Except as disclosed in Chapter titled “Management’s Discussion & Analysis of Financial Conditions & Results of Operations” beginning on page 192, there have been no material developments that have occurred after the Last Balance Sheet Date.

### GOVERNMENT AND OTHER APPROVALS

We have received the necessary consents, licenses, permissions and approvals from the Government and various governmental agencies required for our present business (as applicable on date of this Prospectus) and except as mentioned below, no further approvals are required for carrying on our present business.

In view of the approvals listed below, we can undertake this Offer and our current/proposed business activities and no further major approvals from any governmental or regulatory authority or any other entity are required to be undertaken in respect of the Offer or to continue our business activities. It must be distinctly understood that, in granting these approvals, the Government of India does not take any responsibility for our financial soundness or for the correctness of any of the statements made or opinions expressed in this behalf. Unless otherwise stated, these approvals are all valid as of the date of this Prospectus.

The main objects clause of the Memorandum of Association and objects incidental to the main objects enable our Company to carry out its activities. The following are the details of licenses, permissions and approvals obtained by the Company under various Central and State Laws for carrying out its business:

The Company has got following licenses/registrations/approvals/consents/permissions from the Government and various other Government agencies required for its present business.

#### APPROVALS FOR THE OFFER

Sr. No.	Name of the Approvals
1.	Our Company has received in- principle approval from the SME Platform of NSE dated January 25, 2017 for using the name of the Exchange in its offer document for listing of Equity Shares on SME Platform.
2.	Our Board of Directors have, pursuant to a resolution passed at its meeting held on December 14, 2016 authorized the Offer, subject to the approval of the shareholders of our Company and such other authorities as may be necessary.
3.	The Offer for sale of Equity Shares has been authorized by a special resolution adopted at the Extra Ordinary General Meeting of shareholders held on December 19, 2016.

#### APPROVALS/LICENSES/PERMISSIONS PROCURED TO CONDUCT OUR BUSINESS

##### A. Incorporation documents:

S. No	Nature of Registration/ License	Registration/ License No.	Applicable Laws	Issuing Authority	Date of issue	Date of Expiry
1.	Certificate of Incorporation	17-019288	Companies Act, 1956	Registrar of Companies, Rajasthan, Jaipur	May 14, 2004	Valid till cancelled
2.	Certificate for Commencement of Business	17-019288	Companies Act, 1956	Registrar of Companies, Rajasthan, Jaipur	July 20, 2004	Valid till cancelled

##### B. Business Related Certifications

S. No.	Nature of Registration/ License	Registration/ License No.	Applicable Laws	Issuing Authority	Date of issue	Date of Expiry
<b>(REGISTRATION UNDER VARIOUS ACTS/RULES RELATING TO INCOME TAX, SALES TAX, VALUE ADDED TAX AND CENTRAL EXCISE):</b>						
1.	Permanent Account Number	AACCK4616K	Income Tax Act 1961	Commissioner of Income Tax	October 22, 2008	Valid till cancelled
2.	TAN (Tax Deduction Account Number)	JDHK02801B	Income Tax Department	Income Tax Act 1961	August 30, 2005	Valid till cancelled
3.	Import – Export Code	1308007302	Foreign Trade (Regulation) Rules, 1993	Ministry of Commerce, Office of Joint Director General of Foreign Trade, Jaipur	August 07, 2008	Valid till cancelled



4.	Professional Certificate Registration of employers)	Tax of (for	79229002579	Madhya Pradesh Professional Tax Act, 1995	Professional Tax Officer, Madhya Pradesh	Jhabua,	May 17, 2012	Valid till cancelled
----	---	-------------	-------------	---	--	---------	--------------	----------------------

**INDUSTRIAL AND LABOUR APPROVALS:**

1.	Employee Insurance registration	State	16000521130000 304	Employee Insurance Act, 1948	State	Assistant Director, Sub-Regional Office, Employee's State Insurance Corporation, Udaipur Rajasthan	January 30, 2012	Valid till cancelled
2.	Certificate of Registration with Indian Bureau of Mines	of with	IBM/7964/2011	Mines and Minerals (Regulation and Development) Act, 1957 read with Mineral Conservation and Development Rules, 1988	Controller General, Indian Bureau of Mines, Nagpur		April 23, 2012	Valid till cancelled

Approvals for the manufacturing Unit-I located at 115-120 & 126-133, AKVN Industrial Area, Meghnagar, Jhabua, Madhya Pradesh:-

S. No	Nature of Registration/ License	Registration/License No.	Applicable Laws	Issuing Authority	Date of issue	Date of Expiry
<b>(REGISTRATION UNDER VARIOUS ACTS/RULES RELATING TO INCOME TAX, SALES TAX, VALUE ADDED TAX AND CENTRAL EXCISE):</b>						
1.	Sales Tax and Central Sales Tax Registration Certificate	23621803776	Madhya Pradesh Commercial Tax Department	Madhya Pradesh VAT Act, 2002 and Central Sales Tax Act, 1956	TIN (VAT) & TIN (CST) October 14, 2004	Valid till cancelled
2.	Service Tax Registration	AACCK4616KST001	Finance Act, 1994	Central Excise Officer, Central Excise Range Dhar	October 31, 2007	Valid till cancelled
3.	Central Excise Registration Certificate	AACCK4616KEM001	Rule 9 of Central Excise Rules, 2002	Deputy Commissioner of Central Excise or Assistant Commissioner of Central Excise, Central Board of Excise and Customs, Ratlam	April 24, 2012	Valid till cancelled

**INDUSTRIAL AND LABOUR APPROVALS:**

1.	Provident Certificate of Registration	Fund	No./M.P./IAN/17599/Applicability Cell/387	Employee's Provident Funds 1952	Regional Provident Fund Commissioner	February 26, 2005	Valid till cancelled
2.	Certificate of Registration under Madhya Pradesh Udyog Samvardhan Sahayata Yojana,	of under Nivesh Yojana,	MP TRIFAC/MPIIP AS-10/Reg./29/2012/927	Madhya Pradesh Udyog Nivesh Samvardhan Sahayata Yojana, 2010	Managing Director, M. P. Trade & Investment Facilitation Corporation Limited, Bhopal	March 31, 2011	Valid till cancelled

2010						
3.	Acknowledgement towards Memorandum for proposed Manufacture of Beneficiated Rock Phosphate at total installed capacity of 100000 MT and Beneficiated Rock Phosphate (Processing) at total installed capacity of 200000 MT	952/SIA/IMO/2010	The Industries (Development And Regulation) Act, 1951	Government of India, Ministry of Commerce & Industry, Secretariat for Industrial Assistance, Public Relation & Complaints Section, New Delhi	March 22, 2010	Valid till cancelled
4.	Permission for use of Egyptian Low Grade Phosphate of 26% & 27% P <sub>2</sub> O <sub>5</sub> as raw material for production of notified Beneficiated Rock Phosphate by BRP Plant.	19011/5/2013-MPR	Department of Fertilizers, Ministry of Chemicals and Fertilizers, Govt. of India	Secretary to the Government of India, Ministry of Chemicals and Fertilizers, Department of Fertilizers, Shastri Bhawan, New Delhi	May 16, 2013	Valid till cancelled
5.	Permission to establish the Unit for expanded capacity at Plot No. 115 to 120 & 126 to 133 AKVN Industrial Area, Meghnagar, Jhabua (M P.) from existing capacity of B.R.P. at 300 TPD to proposed SSP at 1,20,000 TPA, G.S.S.P. at 90,000 TPA and for generation of electricity by D.G. set for captive consumption.	4067/TS/MPPC B/2012	Water (Prevention & control of Pollution) and Air (Prevention & control of Pollution) Act, 1981	Member Secretary, Madhya Pradesh Pollution Control Board	June 07, 2012	Valid till cancelled
6.	Acknowledgement towards Memorandum for proposed Manufacture of Single Super Phosphate at proposed total capacity of 120000 MT, Complex fertilizers at total proposed capacity of 90000 MT and Granular Single	3293/SIA/IMO/2010	The Industries (Development And Regulation) Act, 1951	Government of India, Ministry of Commerce & Industry, Secretariat for Industrial Assistance, Public Relation & Complaints Section, New Delhi	September 29, 2010	Valid till cancelled

	Super Phosphate at proposed total capacity of 90000 MT.							
7.	<b>Factory License</b> having manufacturing operations with not more than 250 workers and having motive power of not exceeding 2000 Horse Power	52/12402/JBA/2m (i)	Rule 5 of Madhya Pradesh Factories Rule, 1962 read with Factories Act, 1948	Chief Inspector of Factories, Madhya Pradesh	January 2017	05,	Upto December 31, 2017	
8.	Registration of Principal Employer of an establishment under the Act to hire Contract Labour	18/JBA/Chief Planner/2010	Contract Labor (Regulation and Abolition) Act, 1970	Labour Department of Contract Labour, Jhabua, Madhya Pradesh	August 2010	10,	Valid till cancelled	

**APPROVALS FROM VARIOUS OTHER AUTHORITIES**

1.	Consent and Authorisation to operate for manufacturing of Granulated Single Super Phosphate, Rock phosphate beneficiation, Single Super Phosphate and for Generation of Electricity by DG Set for captive use at production capacity of 90000 M.T, 90000 M.T, 120000 M.T and 325.000 KVA X 2	AWH-45081	Section 25 of the Water (Prevention & Control of Pollution) Act, 1974 under Section 21 of the Air (Prevention & Control of Pollution) Act, 1981 and Hazardous Waste (Management handling & Transboundary movement) Amended Rule, 2008	Member Secretary, Madhya Pradesh Pollution Control Board	December 2015	08,	July 31, 2018
2.	Permission for sale of Single Super Phosphate through M/s Shriram Fertilizers & Chemicals Limited under the Nutrient Based Subsidy (NBS) Policy in the states of Madhya Pradesh, Chhattisgarh, Gujarat, Maharashtra, Rajasthan, Orissa, West Bengal, Tripura and Assam.	17011/1/2016-MPR	The Fertilizer (Control) Order, 1985	Secretary to the Government of India, Department of Fertilizers, New Delhi	June 03, 2016		Valid till 31 <sup>st</sup> March 2017
3.	Permission for sale of 30,000 Ton Single Super Phosphate Fertilizer by the	SI/E6/URV/AN U/2016-17/366	The Fertilizer (Control) Order, 1985	Additional Director of Agriculture, Ministry of	July 20, 2016		March 31, 2017

	brand 'Shriram Super' in the state of Chhattisgarh			Agriculture, Chhattisgarh, Raipur			
4.	Renewal of Authority for sale of Single Super Phosphate, Boronated Single Super Phosphate, Zincated Single Super Phosphate in the brand name of 'Krishna Super' in the state of Chhattisgarh	SI/E6/URV/Reg./2015-16/1342	The Fertilizer (Control) Order, 1985	Additional Director of Agriculture, Ministry of Agriculture, Chhattisgarh, Raipur	September 04, 2015	August 30, 2018	
5.	NOC for sale of SSP Fortified with Zinc, Boronated Single Super Phosphate (Granular), Boronated Single Super Phosphate (Powder), Single Super Phosphate (Powder), Single Super Phosphate (Granular) in the brand name of 'Shriram Super' in the state of Gujarat	No.IQ/QC-5/Ferti. Prmt/160/31765-98/2016	The Fertilizer (Control) Order, 1985	Director of Agriculture, Gujarat State, Gandhinagar	July 01, 2016	March 31, 2017	
6.	Renewal of Authority for sale of Single Super Phosphate (Powder & Granular), Boronated Single Super Phosphate and Zincated Single Super Phosphate in the brand name of 'Krishana Super' in the state of Madhya Pradesh	SI./E-2/URV/P-4/-309-12/309/2094	The Fertilizer (Control) Order, 1985	Joint Ministry of Agriculture, Ex. State Notified Officer, Directorate of Farmer Welfare and Agriculture Development Vindhyachal Bhawan, Madhya Pradesh, Bhopal	August 31, 2015	August 30, 2018	
7.	Permission to sale 80,000 MT Single Super Phosphate through M/s Shriram Fertilizers and Chemicals Limited by the brand of 'Shriram' in the state of Madhya Pradesh	SI./E-2/URV/P-4/425-15/425/1343	The Fertilizer (Control) Order, 1985	Joint Ministry of Agriculture (Fertilizer), Directorate of Farmer Welfare and Agriculture Development Vindhyachal Bhawan, Madhya Pradesh, Bhopal	June 24, 2016	March 31, 2017	
8.	Fertilizer License for sale of Single Super Phosphate (Powdered) and Single Super	LCFD10010060	The Fertilizer (Control) Order, 1985	Chief Quality Control Officer, Commissionerate of Agriculture, Pune	August 13, 2016	August 12, 2019	

	Phosphate (Granulated) in the state of Maharashtra						
9.	Renewal of authority to sale Single Super Phosphate (Powdered / Granular), Boronated Single Super Phosphate (Powdered / Granular) and Zincated Single Super Phosphate (Powder) and for sale by the brand name of 'Shriram Super' in the state of Rajasthan	F 4 (TT) /Fertilizer/1198/2016-17/2457-2504 for renewal of license no. 1173 dated 23.05.2016	The Fertilizer (Control) Order, 1985	Joint Director of Agriculture, Rajasthan, Jaipur	May 23, 2016	Permission to sale in the state of Rajasthan: May 22, 2019 and Permission to sale by the brand name of 'Sriram Super': March 31, 2017	
10.	Certificate for verification of Standard of Weights and Measures, for Eight Electronic Weighting Machines	02/17850	Legal Metrology Act, 2009	Legal Metrology Officer, Jhabua, Madhya Pradesh	September 28, 2016	September 27, 2017	
11.	Certificate for verification of Standard of Weights and Measures for One Electronic Weighting Machines	01/17850	Legal Metrology Act, 2009	Legal Metrology Officer, Jhabua, Madhya Pradesh	September 27, 2016	September 26, 2017	

**Approvals for the manufacturing Unit-II located at 142 & 143, Meghnagar, Jhabua, Madhya Pradesh:-**

S. No	Nature of Registration/ License	Registration/License No.	Applicable Laws	Issuing Authority	Date of issue	Date of Expiry
<b>INDUSTRIAL AND LABOUR APPROVALS:</b>						
1.	Grant of Consent to Establish (For expansion) under Section 25 of the Water (Prevention & Control of Pollution) Act, 1974 under Section 21 of the Air (Prevention & Control of Pollution) Act, 1981	CTE-45183	Section 25 of the Water (Prevention & Control of Pollution) Act, 1974 under Section 21 of the Air (Prevention & Control of Pollution) Act, 1981	Member Secretary, Madhya Pradesh Pollution Control Board	December 30, 2015	November 31, 2020
2.	Environmental Clearance for approval of proposed Manufacturing Unit of Dyes, Intermediates	7307/SEIA A/2015	Environment Impact Assessment (EIA) Notification 2006	Member Secretary, State Environment Impact Assessment Authority, Madhya Pradesh	November 06, 2015	Valid till cancelled
3.	<b>Factory License</b> having manufacturing operations	108/15543/JBU/2m(i)/	Rule 5 of Madhya Pradesh Factories	Chief Inspector of Factories,	November 25, 2016	Upto December

with not more than 50 workers and having motive power of not exceeding 500 Horse Power	H	Rule, 1962 read with Factories Act, 1948	Madhya Pradesh	31, 2017
--	---	--	----------------	----------

**(REGISTRATION UNDER VARIOUS ACTS/RULES RELATING TO INCOME TAX, SALES TAX, VALUE ADDED TAX AND CENTRAL EXCISE):**

1.	VAT and Central Sales Tax Registration Certificate	23719111328	Madhya Pradesh Commercial Tax Department	Madhya Pradesh VAT Act, 2002 and Central Sales Tax Act, 1956	TIN (VAT) dated May 05, 2014 TIN (CST) dated July 30, 2016	Valid till cancelled
2.	Service Tax Registration (Taxable Services: Transport of goods)	AACCK46 I6KSD002	Finance Act, 1994	Superintendent, Central Excise Range Dhar	June 04, 2014	Valid till cancelled
3.	Central Excise Registration Certificate	AACCK46 16KEM002	Rule 9 of Central Excise Rules, 2002	Deputy Commissioner of Central Excise or Assistant Commissioner of Central Excise, Central Board of Excise and Customs, Ratlam	March 05, 2015	Valid till cancelled

**APPROVALS FROM VARIOUS OTHER AUTHORITIES**

1.	Consent and Authorization to operate for manufacturing of Di-Calsiam Phosphate (DCP), E K Acid, H Acid H-acid (by production from e k acid) Pncbosa, Solpho anthranilic acid, Sulpho tobias Acid (STA), Vinyl Sulphone, Voilet Acid	AWH-46005	Section 25 of the Water (Prevention & Control of Pollution) Act, 1974 under Section 21 of the Air (Prevention & Control of Pollution) Act, 1981 and Hazardous Waste & Other Waste (Management handling & Transboundary movement) Rule, 2016.	Member Secretary, Madhya Pradesh Pollution Control Board	August 09, 2016	July 31, 2021
----	---	-----------	--	--	-----------------	---------------

**Approvals for the manufacturing Unit-III located at 126-A & 134, Meghnagar, Jhabua, Madhya Pradesh:-**

S. No	Nature of Registration/ License	Registration/License No.	Applicable Laws	Issuing Authority	Date of issue	Date of Expiry
<b>INDUSTRIAL AND LABOUR APPROVALS:</b>						
1.	Grant of Consent to Establish under Section 25 of the Water (Prevention & Control of Pollution) Act, 1974 under Section 21 of the Air (Prevention & Control of Pollution) Act, 1981	CTE-45184	Section 25 of the Water (Prevention & Control of Pollution) Act, 1974 under Section 21 of the Air (Prevention & Control of Pollution) Act, 1981	Member Secretary, Madhya Pradesh Pollution Control Board	December 30, 2015	November 29, 2020

2.	Sales Tax and Central Sales Tax Registration Certificate	23109175409	Madhya Pradesh Commercial Tax Department	Madhya Pradesh VAT Act, 2002 and Central Sales Tax Act, 1956	VAT – February 18, 2016 and CST - July 30, 2016	Valid till cancelled
----	--	-------------	--	--	---	----------------------

**QUALITY CERTIFICATIONS AND REGISTRATION/MEMBERSHIP OF TRADE ASSOCIATION/EXPORT COUNCIL AND TECHNICAL APPROVALS/ INTELLECTUAL PROPERTY RIGHTS:**

S.No	Nature of Registration/ License	Registration/License No.	Issuing Authority	Date of issue	Date of Expiry
1.	ISO 9001:2008	1014QB03	Absolute Quality Certification Pvt. Ltd.	January 18, 2014	January 17, 2017

**Intellectual Property:-**

Our Company does not own any trademark on its own name except as disclosed below:-

S.No.	Logo/Trademark	Class	Nature of Trademark	Owner	Application No. & Date	Remarks
2.		Class - 1		Krishana Limited	Phoschem Application No.:- 2376371 Date of Application - 08/08/2012	Opposed

In Addition to above, Our company has signed an Agreement for use of Logo dated November 24, 2016 with our Group Company “Ostwal Phoschem (India) Limited (formally known as Tedco Granite Limited)” for use of trademark. Below are the details of trademark used by our Company:-

S.No.	Logo/Trademark	Class	Nature of Trademark	Owner	Application No. & Date	Remarks
1.		Class - 1		Ostwal Phoschem (India) Limited (Formally known as Tedco Granite Limited)	Application No.:- 1927451 Date of Application - 25/02/2010	<b>Valid Upto</b> 25/02/2020

The Details of Domain Name registered on the name of the Company is:-

S.No.	Domain Name and ID	Sponsoring Registrar and IANA ID	Creation Date	Registration Expiry Date
1.	<a href="http://www.krishnaphoschem.com">www.krishnaphoschem.com</a> Registry Domain ID: 1432944007_DOMAIN_COM-VRSN	Registrar: PDR Ltd. d/b/a PublicDomainRegistry.com Registrar IANA ID: 303	March 25, 2008	March 25, 2018

## OTHER REGULATORY AND STATUTORY DISCLOSURES

### Authority for the Offer

The Board of Directors, pursuant to a resolution passed at their meeting held on December 14, 2016 authorized the Offer, subject to the approval of the shareholders of our Company, and such other authorities as may be necessary.

The shareholders of our Company have, pursuant to a special resolution passed at an Extra Ordinary General Meeting held on December 19, 2016 authorized the Offer.

The Selling Shareholders have authorized the transfer of Equity Shares pursuant to the Offer as set out in below table.

Sr. No.	Name of Selling Shareholder	Date of Authorization Letter	Number of Equity Shares offered for sale
1.	Mr. Pankaj Ostwal	December 12, 2016	535,000
2.	Mrs. Nitu Ostwal	December 12, 2016	470,000
3.	Mrs. Ekta Jain	December 12, 2016	475,000
4.	Mahendra Kumar Ostwal HUF	December 12, 2016	550,000
5.	Pankaj Ostwal HUF	December 12, 2016	295,000
6.	Praveen Ostwal HUF	December 12, 2016	295,000
7.	Mahendra Kumar Ostwal	December 12, 2016	80,000
8.	Madhya Bharat Agro Products Ltd.	December 12, 2016	1,785,000
9.	Churni Prints Pvt. Ltd.	December 12, 2016	3,00,000
10.	Paneri Textiles Pvt. Ltd.	December 12, 2016	3,00,000
11.	Archid Products Pvt. Ltd.	December 12, 2016	3,63,750
12.	Seasons Agro Chem India Pvt. Limited	December 12, 2016	11,27,250
<b>Total</b>		December 12, 2016	<b>65,76,000</b>

The Equity shares being offered by the Selling Shareholders have been held for a period of at least one year prior to the date of filing of the Prospectus and, hence, eligible for being offered for sale in the Offer. The Selling Shareholders have confirmed that they have not been prohibited from dealings in securities market and the Equity Shares offered and to be sold are free from any lien, encumbrance or third party rights.

Our Company has obtained in-principle approval from the SME Platform of NSE for using its name in the Prospectus/Prospectus pursuant to an approval letter dated January 25, 2017 NSE is the Designated Stock Exchange.

### Prohibition by SEBI or governmental authorities

We confirm that there is no prohibition on our Company, Selling Shareholders, our Promoters, our Promoters Group, our Directors, our Group Companies or the natural person(s) in control of our Company from accessing or operating in the Capital Markets or restrained from buying, selling or dealing in securities under any order or direction passed by the Board (SEBI) or any other authorities.

The listing of any securities of our Company has never been refused by any of the Stock Exchanges in India.

Neither of our Promoters, Selling Shareholders, Promoter Group, Directors or the person(s) in control of our Company, has ever been part of Promoter, Promoter Group, Directors or the person(s) in control of any other Company which is debarred from accessing the capital market under any order or directions made by the Board (SEBI) or any other regulatory or governmental authority.

### Association with Securities Market

None of our Directors are associated with the securities market and there has been no action taken by the SEBI against the Directors or any other entity with which our Directors are associated as promoters or directors.



### Prohibition by RBI

Neither our Company, Selling Shareholders, our Promoters, our Directors, Group Companies, relatives (as per Companies Act, 2013) of Promoter or the person(s) in control of our Company have been identified as a will full defaulter by the RBI or other governmental authority and there has been no violation of any securities law committed by any of them in the past and no such proceedings are pending against any of them except as details provided in the chapter "Outstanding Litigations and Material Development" beginning on page 205 of the Prospectus.

### Eligibility for the Offer

Our Company is eligible in terms of Regulations 4(2) of SEBI ICDR Regulations for this Offer.

Our Company is an "Unlisted Company" in terms of the SEBI (ICDR) Regulations; and this Offer is an "Initial Public Offer" in terms of the SEBI (ICDR) Regulations.

Our Company is eligible for the Offer in accordance with Regulation 106(M) (2) and other provisions of Chapter XB of the SEBI (ICDR) Regulations, as we are an company whose post Offer paid up capital will be more than ₹ 10 crore and upto twenty five crore rupees and we may hence offer Equity Shares to the public and propose to list the same on the Small and Medium Enterprise Exchange (in this case being the "SME Platform of NSE (NSE EMERGE)).

We confirm that:

1. In accordance with Regulation 106(P) of the SEBI (ICDR) Regulations, this Offer is 100% underwritten and that the LM to the Offer Shall underwrites minimum 15% of the Total Offer Size. For further details pertaining to said underwriting please refer to section titled "General Information – Underwriting" beginning on page 50 of this Prospectus.
2. In accordance with Regulation 106(R) of the SEBI (ICDR) Regulations, we shall ensure that the total number of proposed allottees in the Offer shall be greater than or equal to fifty (50), otherwise, the entire application money will be unblocked forthwith. If such money is not repaid within eight (8) Working Days from the date our Company becomes liable to repay it, then our Company and every officer in default shall, on and from expiry of eight (8) Working Days, be liable to repay such application money, with an interest at the rate as prescribed under the Companies Act 2013.
3. In accordance with Regulation 106(O) the SEBI (ICDR) Regulations, we have not filed any of this Offer Document with SEBI nor has SEBI issued any observations on our Offer Document. Also, we shall ensure that our Lead Manager submits a copy of the Prospectus along with a Due Diligence Certificate including additional confirmations as required to SEBI at the time of filing the Prospectus with Stock Exchange and the Registrar of Companies.
4. In accordance with Regulation 106(V) of the SEBI (ICDR) Regulations, we hereby confirm that we have entered into an agreement with the LM and will enter into agreement with Market Maker to ensure compulsory Market Making for a minimum period of three (3) years from the date of listing of Equity Shares on the SME Platform of NSE. For further details of the arrangement of market making please refer to section titled "General Information – Details of the Market Making Arrangements for this Offer" beginning on page 50 of this Prospectus.

We further confirm that we shall be complying with all the other requirements as laid down for such an offer under Chapter XB of SEBI (ICDR) Regulations, as amended from time to time and subsequent circulars and guidelines issued by SEBI and the Stock Exchange.

As per Regulation 106(M)(3) of SEBI (ICDR) Regulations, the provisions of Regulations 6(1), 6(2), 6(3), Regulation 8, Regulation 9, Regulation 10, Regulation 25, Regulation 26, Regulation 27 and sub-regulation (1) of Regulation 49 of SEBI (ICDR) Regulations, 2009 shall not apply to us in this Offer.

5. Our Company shall mandatorily facilitate trading in demat securities and will enter into an agreement with both the depositories. The Company has entered into an agreement for registration with the Central Depository Services Limited (CDSL) dated January 14, 2017 and National Securities Depository Limited dated January 25, 2017 for establishing connectivity
6. Our Company has a website i.e. [www.krishnaphoschem.com](http://www.krishnaphoschem.com)
7. There has been no change in the promoter/s of the Company in the preceding one year from date of filing application to NSE for listing on SME segment.

We confirm that we comply with all the below requirements / conditions so as to be eligible to be listed on the SME Platform of the NSE (NSE EMERGE):-

1. Our Company was originally incorporated as Krishana Phoschem Limited on May 14, 2004 as public limited company under the Companies Act, 1956 with Registrar of Companies, Rajasthan, Jaipur.
2. The Post Offer paid up capital of the company will be 2,49,00,000 shares of face value of ₹ 10/- aggregating to ₹ 24.90 Crore which is less than ₹ 25 Crore.
3. The company confirms that it has track record of more than 3 years.
4. The company confirms that it has positive cash accruals (earnings before depreciation and tax) from operations for atleast 2 financial years preceding the application and its net-worth as on November 30, 2016 is positive.
5. Our Company has not been referred to the Board for Industrial and Financial Reconstruction (BIFR).
6. There is no winding up petition against our Company that has been admitted by the Court or a liquidator has not been appointed of competent Jurisdiction against the Company.
7. No material regulatory or disciplinary action by a stock exchange or regulatory authority in the past three years against the company.
8. Our Company confirms that there is no material regulatory or disciplinary action by a stock exchange or regulatory authority in the past one year in respect of promoters, Group Companies, companies promoted by the promoters of the company.

#### **Compliance with Part A of Schedule VIII of the SEBI (ICDR) Regulations**

Our Company is in compliance with the provisions specified in Part A of the SEBI (ICDR) Regulations. No exemption from eligibility norms has been sought under Regulation 109 of the SEBI (ICDR) Regulations, with respect to the Offer. Further, our Company has not been formed by the conversion of a partnership firm into a company.

#### **DISCLAIMER CLAUSE OF SEBI**

**IT IS TO BE DISTINCTLY UNDERSTOOD THAT SUBMISSION OF OFFER DOCUMENT TO THE SECURITIES AND EXCHANGE BOARD OF INDIA (SEBI) SHOULD NOT IN ANY WAY BE DEEMED OR CONSTRUED THAT THE SAME HAS BEEN CLEARED OR APPROVED BY SEBI. SEBI DOES NOT TAKE ANY RESPONSIBILITY EITHER FOR THE FINANCIAL SOUNDNESS OF ANY SCHEME OR THE PROJECT FOR WHICH THE OFFER IS PROPOSED TO BE MADE OR FOR THE CORRECTNESS OF THE STATEMENTS MADE OR OPINIONS EXPRESSED IN THE OFFER DOCUMENT. THE LEAD MERCHANT BANKER, HEM SECURITIES LIMITED HAS CERTIFIED THAT THE DISCLOSURES MADE IN THE OFFER DOCUMENT ARE GENERALLY ADEQUATE AND ARE IN CONFORMITY WITH THE SEBI (ISSUE OF CAPITAL AND DISCLOSURE REQUIREMENTS) REGULATIONS, 2009 IN FORCE FOR THE TIME BEING. THIS REQUIREMENT IS TO FACILITATE INVESTORS TO TAKE AN INFORMED DECISION FOR MAKING INVESTMENT IN THE PROPOSEDOFFER.**

**IT SHOULD ALSO BE CLEARLY UNDERSTOOD THAT WHILE THE COMPANY IS PRIMARILY RESPONSIBLE FOR THE CORRECTNESS, ADEQUACY AND DISCLOSURE OF ALL RELEVANT INFORMATION IN THE OFFER DOCUMENT, THE LEAD MERCHANT BANKER, HEM SECURITIES LIMITED IS EXPECTED TO EXERCISE DUE DILIGENCE TO ENSURE THAT THE COMPANY AND THE SELLING SHAREHOLDERS DISCHARGES ITS RESPONSIBILITY ADEQUATELY IN THIS BEHALF AND TOWARDS THIS PURPOSE, THE LEAD MERCHANT BANKER HAS FURNISHED TO SEBI A DUE DILIGENCE CERTIFICATE DATED FEBRUARY 06, 2017 WHICH READS AS FOLLOWS:**

**WE, THE UNDER NOTED LEAD MANAGER TO THE ABOVE MENTIONED FORTHCOMING OFFER STATE AND CONFIRM AS FOLLOWS:**

1. WE HAVE EXAMINED VARIOUS DOCUMENTS INCLUDING THOSE RELATING TO LITIGATION LIKE COMMERCIAL DISPUTES, PATENT DISPUTES, DISPUTES WITH COLLABORATORS, ETC. AND OTHER MATERIAL IN CONNECTION WITH THE FINALISATION OF THE PROSPECTUS PERTAINING TO THE SAID OFFER
2. ON THE BASIS OF SUCH EXAMINATION AND THE DISCUSSIONS WITH THE COMPANY, THE SELLING SHAREHOLDERS, ITS DIRECTORS AND OTHER OFFICERS, OTHER AGENCIES, AND INDEPENDENT VERIFICATION OF THE STATEMENTS CONCERNING THE OBJECTS OF THE OFFER, PRICE JUSTIFICATION AND THE CONTENTS OF THE DOCUMENTS AND OTHER PAPERS FURNISHED BY THE COMPANY, WE CONFIRM THAT:
  - A. THE PROSPECTUS FILED WITH THE EXCHANGE IS IN CONFORMITY WITH THE DOCUMENTS, MATERIALS AND PAPERS RELEVANT TO THE OFFER;
  - B. ALL THE LEGAL REQUIREMENTS RELATING TO THE OFFER AS ALSO THE REGULATIONS GUIDELINES, INSTRUCTIONS, ETC. FRAMED/ISSUED BY THE BOARD, THE CENTRAL GOVERNMENT AND ANY OTHER COMPETENT AUTHORITY IN THIS BEHALF HAVE BEEN DULY COMPLIED WITH; AND
  - C. THE DISCLOSURES MADE IN THE PROSPECTUS ARE TRUE, FAIR AND ADEQUATE TO ENABLE THE INVESTORS TO MAKE A WELL INFORMED DECISION AS TO THE INVESTMENT IN THE PROPOSED OFFER AND SUCH DISCLOSURES ARE IN ACCORDANCE WITH THE REQUIREMENTS OF THE COMPANIES ACT, 2013, APPLICABLE PROVISIONS OF THE COMPANIES ACT, 1956, THE SECURITIES AND EXCHANGE BOARD OF INDIA (ISSUE OF CAPITAL AND DISCLOSURE REQUIREMENTS) REGULATIONS, 2009 AND OTHER APPLICABLE LEGAL REQUIREMENTS.
3. WE CONFIRM THAT BESIDES OURSELVES, ALL THE INTERMEDIARIES NAMED IN THE PROSPECTUS ARE REGISTERED WITH THE BOARD AND THAT TILL DATE SUCH REGISTRATION IS VALID.
4. WE HAVE SATISFIED OURSELVES ABOUT THE CAPABILITY OF THE UNDERWRITERS TO FULFILL THEIR UNDERWRITING COMMITMENTS.
5. WE CERTIFY THAT WRITTEN CONSENT FROM PROMOTER HAS BEEN OBTAINED FOR INCLUSION OF THEIR SPECIFIED SECURITIES AS PART OF PROMOTERS' CONTRIBUTION SUBJECT TO LOCK-IN AND THE SPECIFIED SECURITIES PROPOSED TO FORM PART OF PROMOTERS' CONTRIBUTION SUBJECT TO LOCK-IN SHALL NOT BE DISPOSED / SOLD / TRANSFERRED BY THE PROMOTER DURING THE PERIOD STARTING FROM THE DATE OF FILING THE PROSPECTUS WITH THE BOARD TILL THE DATE OF COMMENCEMENT OF LOCK-IN PERIOD AS STATED IN THE PROSPECTUS.
6. WE CERTIFY THAT REGULATION 33 OF THE SECURITIES AND EXCHANGE BOARD OF INDIA (ISSUE OF CAPITAL AND DISCLOSURE REQUIREMENTS) REGULATIONS, 2009, WHICH RELATES TO SPECIFIED SECURITIES INELIGIBLE FOR COMPUTATION OF PROMOTERS CONTRIBUTION, HAS BEEN DULY COMPLIED WITH AND APPROPRIATE DISCLOSURES AS TO COMPLIANCE WITH THE SAID REGULATION HAVE BEEN MADE IN THE PROSPECTUS.
7. WE UNDERTAKE THAT SUB-REGULATION (4) OF REGULATION 32 AND CLAUSE (C) AND (D) OF SUB-REGULATION (2) OF REGULATION 8 OF THE SECURITIES AND EXCHANGE BOARD OF INDIA (ISSUE OF CAPITAL AND DISCLOSURE REQUIREMENTS) REGULATIONS, 2009 SHALL BE COMPLIED WITH. WE CONFIRM THAT ARRANGEMENTS HAVE BEEN MADE TO ENSURE THAT PROMOTERS' CONTRIBUTION SHALL BE RECEIVED AT LEAST ONE DAY BEFORE THE OPENING OF THE OFFER. WE UNDERTAKE THAT AUDITORS' CERTIFICATE TO THIS EFFECT SHALL BE DULY SUBMITTED TO THE BOARD. WE FURTHER CONFIRM THAT ARRANGEMENTS HAVE BEEN MADE TO ENSURE THAT PROMOTERS' CONTRIBUTION SHALL BE KEPT IN AN ESCROW ACCOUNT WITH A SCHEDULED COMMERCIAL BANK AND SHALL BE RELEASED TO THE COMPANY ALONG WITH THE PROCEEDS OF THE PUBLIC OFFER. – NOT APPLICABLE

8. WE CERTIFY THAT THE PROPOSED ACTIVITIES OF THE COMPANY FOR WHICH THE FUNDS ARE BEING RAISED IN THE PRESENT OFFER FALL WITHIN THE 'MAIN OBJECTS' LISTED IN THE OBJECT CLAUSE OF THE MEMORANDUM OF ASSOCIATION OR OTHER CHARTER OF THE COMPANY AND THAT THE ACTIVITIES WHICH HAVE BEEN CARRIED OUT UNTIL NOW ARE VALID IN TERMS OF THE OBJECT CLAUSE OF ITS MEMORANDUM OF ASSOCIATION
9. WE CONFIRM THAT NECESSARY ARRANGEMENTS HAVE BEEN MADE TO ENSURE THAT THE MONEYS RECEIVED PURSUANT TO THE OFFER ARE KEPT IN A SEPARATE BANK ACCOUNT AS PER THE PROVISIONS OF SUB-SECTION (3) OF SECTION 40 OF THE COMPANIES ACT, 2013 AND THAT SUCH MONEYS SHALL BE RELEASED BY THE SAID BANK ONLY AFTER PERMISSION IS OBTAINED FROM ALL THE STOCK EXCHANGES MENTIONED IN THE PROSPECTUS. WE FURTHER CONFIRM THAT THE AGREEMENT ENTERED INTO BETWEEN THE BANKERS TO THE OFFER AND THE COMPANY SPECIFICALLY CONTAINS THIS CONDITION - NOTED FOR COMPLIANCE
10. WE CERTIFY THAT A DISCLOSURE HAS BEEN MADE IN THE PROSPECTUS THAT THE INVESTORS SHALL BE GIVEN AN OPTION TO GET THE SHARES IN DEMAT OR PHYSICAL MODE. NOT APPLICABLE. UNDER SECTION 29 OF THE COMPANIES ACT, 2013, THE EQUITY SHARES ARE TO BE ISSUED IN DEMATERIALIZED FORM ONLY.
11. WE CERTIFY THAT ALL THE APPLICABLE DISCLOSURES MANDATED IN THE SECURITIES AND EXCHANGE BOARD OF INDIA (ISSUE OF CAPITAL AND DISCLOSURE REQUIREMENTS) REGULATIONS, 2009 HAVE BEEN MADE IN ADDITION TO DISCLOSURES WHICH, IN OUR VIEW, ARE FAIR AND ADEQUATE TO ENABLE THE INVESTOR TO MAKE A WELL INFORMED DECISION.
12. WE CERTIFY THAT THE FOLLOWING DISCLOSURES HAVE BEEN MADE IN THE PROSPECTUS:
  - A. AN UNDERTAKING FROM THE COMPANY THAT AT ANY GIVEN TIME, THERE SHALL BE ONLY ONE DENOMINATION FOR THE EQUITY SHARES OF THE COMPANY AND
  - B. AN UNDERTAKING FROM THE COMPANY THAT IT SHALL COMPLY WITH SUCH DISCLOSURE AND ACCOUNTING NORMS SPECIFIED BY THE BOARD FROM TIME TO TIME.
13. WE UNDERTAKE TO COMPLY WITH THE REGULATIONS PERTAINING TO ADVERTISEMENT IN TERMS OF THE SECURITIES AND EXCHANGE BOARD OF INDIA (ISSUE OF CAPITAL AND DISCLOSURE REQUIREMENTS) REGULATIONS, 2009 WHILE MAKING THE OFEFR - NOTED FOR COMPLIANCE
14. WE ENCLOSE A NOTE EXPLAINING HOW THE PROCESS OF DUE DILIGENCE HAS BEEN EXERCISED BY US IN VIEW OF THE NATURE OF CURRENT BUSINESS BACKGROUND OR THE COMPANY, SITUATION AT WHICH THE PROPOSED BUSINESS STANDS, THE RISK FACTORS, PROMOTERS EXPERIENCE, ETC.
15. WE ENCLOSE A CHECKLIST CONFIRMING REGULATION-WISE COMPLIANCE WITH THE APPLICABLE PROVISIONS OF THE SECURITIES AND EXCHANGE BOARD OF INDIA (ISSUE OF CAPITAL AND DISCLOSURE REQUIREMENTS) REGULATIONS, 2009, CONTAINING DETAILS SUCH AS THE REGULATION NUMBER, ITS TEXT, THE STATUS OF COMPLIANCE, PAGE NUMBER OF THE PROSPECTUS WHERE THE REGULATION HAS BEEN COMPLIED WITH AND OUR COMMENTS, IF ANY.
16. WE ENCLOSE STATEMENT ON 'PRICE INFORMATION OF PAST ISSUES HANDLED BY MERCHANT BANKER BELOW (WHO ARE RESPONSIBLE FOR PRICING THIS ISSUE)', AS PER FORMAT SPECIFIED BY SEBI THROUGH CIRCULAR NO. CIR/CFD/DIL/7/2015 DATED OCTOBER 30, 2015.
17. WE CERTIFY THAT PROFITS FROM RELATED PARTY TRANSACTIONS HAVE ARISEN FROM LEGITIMATE BUSINESS TRANSACTIONS - TO THE EXTENT OF THE RELATED PARTY TRANSACTIONS REPORTED IN ACCORDANCE WITH ACCOUNTING STANDARD-18 IN THE FINANCIAL INFORMATION OF THE COMPANY INCLUDED IN THE PROSPECTUS.

**ADDITIONAL CONFIRMATIONS/ CERTIFICATION TO BE GIVEN BY MERCHANT BANKER IN DUE DILIGENCE CERTIFICATE TO BE GIVEN ALONG WITH OFFER DOCUMENT REGARDING SME EXCHANGE**

1. WE CONFIRM THAT NONE OF THE INTERMEDIARIES NAMED IN THE PROSPECTUS HAVE BEEN DEBARRED FROM FUNCTIONING BY ANY REGULATORY AUTHORITY.
2. WE CONFIRM THAT ALL THE MATERIAL DISCLOSURES IN RESPECT OF THE COMPANY HAVE BEEN MADE IN PROSPECTUS AND CERTIFY THAT ANY MATERIAL DEVELOPMENT IN THE COMPANY OR RELATING TO THE OFFER UP TO THE COMMENCEMENT OF LISTING AND TRADING OF THE SPECIFIED SECURITIES OFFERED THROUGH THIS OFFER SHALL BE INFORMED THROUGH PUBLIC NOTICES/ ADVERTISEMENTS IN ALL THOSE NEWSPAPERS IN WHICH PRE-OFFER ADVERTISEMENT AND ADVERTISEMENT FOR OPENING OR CLOSURE OF THE OFFER HAVE BEEN GIVEN.
3. WE CONFIRM THAT THE ABRIDGED PROSPECTUS CONTAINS ALL THE DISCLOSURES AS SPECIFIED IN THE SECURITIES AND EXCHANGE BOARD OF INDIA (ISSUE OF CAPITAL AND DISCLOSURE REQUIREMENTS) REGULATIONS, 2009 - NOTED FOR COMPLIANCE.
4. WE CONFIRM THAT AGREEMENTS HAVE BEEN ENTERED INTO WITH THE DEPOSITORIES FOR DEMATERIALISATION OF THE SPECIFIED SECURITIES OF THE COMPANY
5. WE CERTIFY THAT AS PER THE REQUIREMENTS OF FIRST PROVISIO TO SUB-REGULATION (4) OF REGULATION 32 OF SECURITIES AND EXCHANGE BOARD OF INDIA (ISSUE OF CAPITAL AND DISCLOSURE REQUIREMENTS) REGULATIONS, 2009; CASH FLOW STATEMENT HAS BEEN PREPARED AND DISCLOSED IN THE PROSPECTUS. - NOT APPLICABLE
6. WE CONFIRM THAT UNDERWRITING AND MARKET MAKING ARRANGEMENTS AS PER REQUIREMENTS OF REGULATION 106P AND 106V OF THE SECURITIES AND EXCHANGE BOARD OF INDIA (ISSUE OF CAPITAL AND DISCLOSURE REQUIREMENTS) REGULATIONS, 2009 HAVE BEEN MADE.

**Note:**

The filing of this Prospectus does not, however, absolve our company from any liabilities under section 34, section 35, Section 36 and Section 38 (1) of the Companies Act, 2013 or from the requirement of obtaining such statutory and / or other clearances as may be required for the purpose of the proposed Offer. SEBI further reserves the right to take up at any point of time, with the LM any irregularities or lapses in the Prospectus.

All legal requirements pertaining to the Offer will be complied with at the time of registration of the Prospectus with the Registrar of Companies, Rajasthan, Jaipur in terms of sections 26, 32 and 33 of the Companies Act, 2013.

**Statement on Price Information of Past Issues handled by Hem Securities Limited:**

Sr. No	Issue name	Issue size (Rs in Cr.)	Issue Price (Rs.)	Listing date	Opening Price on listing date	+/- % change in closing price, [+/- % change in closing benchmark]- 30 <sup>th</sup> calendar days from listing	+/- % change in closing price, [+/- % change in closing benchmark]- 90 <sup>th</sup> calendar days from listing	+/- % change in closing price, [+/- % change in closing benchmark]- 180 <sup>th</sup> calendar days from listing
1.	Vishal Bearings Limited	3.24	25.00	October 15, 2015	26.00	22.00% [-4.69%]	16.4% [-8.62%]	16% [8.17%]
2.	Arambhan Hospitality Services Ltd (Formerly known	1.862	14.00	October 19, 2015	15.25	103.57% [-5.48%]	142.86% [-11.61%]	125% [-9.82%]

	as “Cawasji Behramji Catering Services Limited”)								
3.	Raghav Ramming Mass Limited	7.48	39.00	April 13, 2016	41.00	3.85% [-0.54%]	44.61% [8.51%]	75.64% [9.58%]	
4.	Advance Syntex Limited	2.52	12.00	July 12, 2016	13.25	0.00% [0.19%]	-2.08% [0.99%]	29.00% [-3.89%]	
5.	Madhya Bharat Agro Products Ltd	13.89	24.00	Sept. 12, 2016	27.00	19.97% [-1.63%]	62.50% [-6.25%]	NA	
6.	Aurangabad Distillery Limited	7.70	35.00	October 17, 2016	42.00	81.85% [-4.80%]	117.14% [-1.26%]	NA	
7.	Pansari Developers Limited	10.1904	22.00	October 18, 2016	22.90	3.41% [-6.89%]	-4.55% [-3.05%]	NA	
8.	Dhanuka Realty Limited	4.224	40.00	October 18, 2016	41.25	-8.13% [-6.89%]	-6.25% [-3.05%]	NA	
9.	Globe international Carriers Limited	5.1696	24.00	October 19, 2016	24.95	0.00% [-6.75%]	-1.46% [-3.02%]	NA	
10.	Art Nirman Limited	5.01	25.00	October 19, 2016	30.00	12.00% [-6.75%]	12.20% [-3.02%]	NA	

Source: Price Information [www.bseindia.com](http://www.bseindia.com) & [www.nseindia.com](http://www.nseindia.com), Issue Information from respective Prospectus.

**Summary statement of Disclosure:**

Financial Year	Total no. of IPOs	Total amount of funds raised (Rs. Cr.)	No. of IPOs trading at discount- 30 <sup>th</sup> calendar days from listing			No. of IPOs trading at Premium- 30 <sup>th</sup> calendar days from listing			No. of IPOs trading at discount- 180 <sup>th</sup> calendar days from listing			No. of IPOs trading at Premium- 180 <sup>th</sup> calendar days from listing		
			Over 50%	Between 25-50%	Less than 25%	Over 50%	Between 25-50%	Less than 25%	Over 50%	Between 25-50%	Less than 25%	Over 50%	Between 25-50%	Less than 25%
2013-14	3 <sup>(1)</sup>	10.66	-	-	1	1	1	-	-	-	-	2	-	1
2014-15	7 <sup>(2)</sup>	38.25	-	-	-	2	-	5	-	-	-	3	-	4
2015-16	8 <sup>(3)</sup>	34.20	-	-	1	2	2	3	-	-	-	3	1	4
2016-17	8 <sup>(4)</sup>	56.18	-	-	1	1	-	6	-	-	-	1	1	-

(1) The scrips of Samruddhi Realty Limited, Captain Polyplast Limited and Tentiwal Wire Products Limited were listed on April 12, 2013, December 11, 2013 and December 31, 2013 respectively.

(2) The scrips of R&B Denims Limited, Bansal Roofing Products Limited, Atishay Infotech Limited, Dhabriya Polywood Limited, Vibrant Global Capital Limited, ADCC Infocad Limited and Captain Pipes Limited were listed on April 22, 2014, July 14, 2014, October 16, 2014, October 17, 2014, October 21, 2014, October 22, 2014, and December 11, 2014 respectively.

(3) The scrips of O.P. Chains Limited, Junction Fabrics and Apparels Limited, Loyal Equipments Limited, Emkay Taps & Cutting Tools Limited, Universal Autofoundry Limited, Bella Casa Fashion and Retail Limited, Vishal Bearings Limited and Cawasji Behramji Catering Services Limited were listed on April 22, 2015, July 10, 2015, July 16, 2015, August 13, 2015, September 4, 2015, October 15, 2015, October 15, 2015 and October 19, 2015 respectively.

(4) The scrips of Raghav Ramming Mass Limited and Advance Syntex Limited was listed on April 13, 2016 and July 12, 2016 respectively, Further Madhya Bharat Agro Products Limited has not completed its 180 days from the listing date. Further, Aurangabad Distillery Limited, Pansari Developers Limited, Dhanuka Realty Limited, Globe International Carriers Limited and Art Nirman Limited were listed on October 17, 2016, October 18<sup>th</sup>, 2016, October 18<sup>th</sup>, 2016, October 19<sup>th</sup>, 2016 and October 19<sup>th</sup>, 2016 respectively and has not completed 180<sup>th</sup> day from date of listing.

Note:

- a) Based on date of listing.
- b) BSE SENSEX and CNX NIFTY has been considered as the benchmark index.
- c) Prices on BSE/NSE are considered for all of the above calculations.
- d) In case 30<sup>th</sup> /90<sup>th</sup> /180<sup>th</sup> day is not a trading day, closing price on BSE/NSE of the next trading day has been considered.
- e) In case 30<sup>th</sup> /90<sup>th</sup> /180<sup>th</sup> day, scrips are not traded then last trading price has been considered.
- f) N.A. - Period not completed.
- g) As per SEBI Circular No. CIR/CFD/DIL/7/2015 dated October 30, 2015, the above table should reflect max. 10 issues (initial public offerings managed by the lead manager. Hence, disclosures pertaining to recent 10 issues handled by lead manager are provided.

**Track Record of past issues handled by Hem Securities Limited**

For details regarding track record of LM to the Offer as specified in the Circular reference no. CIR/MIRSD/1/2012 dated January 10, 2012 issued by the SEBI, please refer the website of the LM at: [www.hemsecurities.com](http://www.hemsecurities.com)

**Disclaimer from our Company, Selling Shareholders, Directors and the Lead Manager**

Our Company, the Directors, Selling Shareholders and the Lead Manager accept no responsibility for statements made otherwise than those contained in this Prospectus or, in case of the Company, in any advertisements or any other material issued by or at our Company's instance and anyone placing reliance on any other source of information would be doing so at his or her own risk.

The LM accept no responsibility, save to the limited extent as provided in the Agreement entered between the LM, Selling Shareholders and our Company on December 20, 2016 and the Underwriting Agreement dated January 31, 2017 entered into between the Underwriters, Selling Shareholders, Syndicate Members and our Company and the Market Making Agreement dated January 31, 2017 entered into among the Market Maker, LM and our Company.

All information shall be made available by our Company, the Selling Shareholders and the Lead Manager to the public and investors at large and no selective or additional information would be available for a section of the investors in any manner whatsoever including at road show presentations, in research or sales reports, at bidding centres or elsewhere.

The Lead Manager and their respective associates and affiliates may engage in transactions with, and perform services for, our Company, our Promoter Group, Group Entities, or our affiliates or associates or Selling Shareholders in the ordinary course of business and have engaged, or may in future engage, in commercial banking and investment banking transactions with our Company, our Promoter Group, Group Entities, and our affiliates or associates or Selling Shareholders, for which they have received and may in future receive compensation.

**Note**

Applicants who apply in the Offer will be required to confirm and will be deemed to have represented to our Company, the Selling Shareholders and the Underwriters and their respective directors, officers, agents, affiliates and representatives that they are eligible under all applicable laws, rules, regulations, guidelines and approvals to acquire Equity Shares of our Company and will not offer, sell, pledge or transfer the Equity Shares of our Company to any person who is not eligible under applicable laws, rules, regulations, guidelines and approvals to acquire Equity Shares of our Company. Our Company, the Underwriters and their respective directors, officers, agents, affiliates and representatives accept no responsibility or liability for advising any investor on whether such investor is eligible to acquire the Equity Shares in the Offer.

**Disclaimer in Respect of Jurisdiction**

This Offer is being made in India to persons resident in India (including Indian nationals resident in India who are majors, HUFs, companies, corporate bodies and societies registered under applicable laws in India and authorized to invest in shares, Indian mutual funds registered with SEBI, Indian financial institutions, commercial banks, regional rural banks, cooperative banks (subject to RBI permission), or trusts under applicable trust law and who are authorized under their constitution to hold and invest in shares, public financial institutions as specified in Section 2(72) of the Companies Act, 2013, VCFs, state industrial development corporations, insurance companies registered with the Insurance Regulatory and Development Authority, provident funds (subject to applicable law) with a minimum corpus of ₹ 2,500.00 Lakhs and pension funds with a minimum corpus of ₹ 2,500.00 Lakhs, and permitted non-residents including FIIs, Eligible NRIs, multilateral and bilateral development financial institutions, FVCIs and eligible foreign investors, insurance funds set up and managed by army, navy or air force of the Union of India and insurance funds set up and managed by the Department of Posts, India provided that they are eligible under all applicable laws and regulations to hold Equity Shares of our Company. This Prospectus does not, however, constitute an offer to sell or an invitation to subscribe for Equity Shares offered hereby in any jurisdiction other than India to any person to whom it is unlawful to make an offer or invitation in such jurisdiction. Any person into whose possession this Prospectus comes is required to inform himself or herself about, and to observe, any such restrictions. Any dispute arising out of this Offer will be subject to jurisdiction of the competent court(s) in Jaipur, Rajasthan, India only.

No action has been, or will be, taken to permit a public offering in any jurisdiction where action would be required for that purpose. Accordingly, the Equity Shares represented hereby may not be offered or sold, directly or indirectly, and this Prospectus may not be distributed in any jurisdiction, except in accordance with the legal requirements applicable in such jurisdiction. Neither the delivery of this Prospectus nor any sale hereunder shall, under any circumstances, create any implication that there has been no change in the affairs of our Company from the date hereof or that the information contained herein is correct as of any time subsequent to this date.

**Disclaimer Clause of the SME Platform of NSE**

As required, a copy of this Offer Document has been submitted to National Stock Exchange of India Limited (hereinafter referred to as NSE). NSE has given vide its letter January 25, 2017 permission to the Company to use the Exchange's name in this Offer Document as one of the stock exchanges on which this Company's securities are proposed to be listed. The Exchange has scrutinized offer document for its limited internal purpose of deciding on the matter of granting the aforesaid permission to this Company. It is to be distinctly understood that the aforesaid permission given by NSE should not in any way be deemed or construed that the offer document has been cleared or approved by NSE; nor does it in any manner warrant, certify or endorse the correctness or completeness of any of the contents of this offer document; nor does it warrant that this Company's securities will be listed or will continue to be listed on the Exchange; nor does it take any responsibility for the financial or other soundness of this Company, its Promoter, its management or any scheme or project of this Company.

Every person who desires to apply for or otherwise acquire any securities of this Company may do so pursuant to independent inquiry, investigation and analysis and shall not have any claim against the Exchange whatsoever by reason of any loss which may be suffered by such person consequent to or in connection with such subscription /acquisition whether by reason of anything stated or omitted to be stated herein or any other reason whatsoever.

**Disclaimer Clause under Rule 144A of the U.S. Securities Act**

The Equity Shares have not been, and will not be, registered under the U.S. Securities Act 1933, as amended (the "Securities Act") or any state securities laws in the United States and may not be offered or sold within the United States or to, or for the account or benefit of, "U.S. persons" (as defined in Regulation S under the Securities Act), except pursuant to an exemption from, or in a transaction not subject to, the registration requirements of the Securities Act. Accordingly, the Equity Shares will be offered and sold outside the United States in compliance with Regulation S of the Securities Act and the applicable laws of the jurisdiction where those offers and sales occur. The Equity Shares have not been, and will not be, registered, listed or otherwise qualified in any other jurisdiction outside India and may not be offered or sold, and Bids may not be made by persons in any such jurisdiction, except in compliance with the applicable laws of such jurisdiction.

Further, each Applicant where required agrees that such Applicant will not sell or transfer any Equity Shares or create any economic interest therein, including any off-shore derivative instruments, such as participatory notes, issued against the Equity Shares or any similar security, other than pursuant to an exemption from, or in a transaction not subject to, the registration requirements of the Securities Act and in compliance with applicable laws and legislations in each jurisdiction, including India.



**Filing**

The Draft Prospectus/ Prospectus are being filed with National Stock Exchange of India Limited, Exchange Plaza, Plot No. C/1, G Block, Bandra- Kurla Complex, Bandra ( East), Mumbai-400051, Maharashtra

A copy of this Prospectus shall not be filed with the SEBI, nor will SEBI issue any observation on the offer document in term of Regulation 106(M) (3) of the SEBI (ICDR) Regulations. However, a copy of the Prospectus shall be filed with SEBI at the Securities and Exchange Board of India, SEBI Western Regional Office, SEBI Unit No. 002, Ground Floor SAKAR I near Gandhigram Railway Station, Opposite Nehru Bridge, Ashram Road, Ahmedabad-380009, Gujarat for their record purpose only.

A copy of the Prospectus, along with the documents required to be filed under Section 32 of the Companies Act, 2013 would be delivered for registration to the Registrar of Companies, Corporate Bhawan, G/6-7, Second Floor, Residency Area, Civil Lines, Jaipur-302001, Rajasthan.

**Listing**

The Equity Shares of our Company are proposed to be listed on SME Platform of NSE. Our Company has obtained in-principle approval from NSE by way of its letter dated January 25, 2017 for listing of equity shares on SME Platform of NSE.

NSE will be the Designated Stock Exchange, with which the Basis of Allotment will be finalized for the Offer. If the permission to deal in and for an official quotation of the Equity Shares on the SME Platform is not granted by NSE, our Company and selling shareholders shall forthwith repay, without interest, all moneys received from the applicants in pursuance of this Prospectus.

If such money is not repaid within the prescribed time then our Company and selling shareholders becomes liable to repay it, then our Company and every officer in default and selling shareholders shall, be liable to repay such application money, with interest, as prescribed under the applicable law.

Our Company shall ensure that all steps for the completion of the necessary formalities for listing and commencement of trading at the SME Platform of NSE mentioned above are taken within Six (6) Working Days of the Offer Closing Date. If Equity Shares are not Allotted pursuant to the Offer within Six (6) Working Days from the Offer Closing Date or within such timeline as prescribed by the SEBI, our Company and selling shareholders shall repay with interest all monies received from applicants, failing which interest shall be due to be paid to the applicants at the rate of 15% per annum for the delayed period. Subject to applicable law.

**Impersonation**

Attention of the Applicants is specifically drawn to the provisions of sub-section (1) of Section 38 of the Companies Act, 2013 which is reproduced below:

Any person who-

- a) Makes or abets making of an application in a fictitious name to a company for acquiring, or subscribing for, its securities; or
- b) Makes or abets making of multiple applications to a company in different names or in different combinations of his name or surname for acquiring or subscribing for its securities; or
- c) Otherwise induces directly or indirectly a company to allot, or register any transfer of, securities to him, or to any other person in a fictitious name,

Shall be liable to action under section 447 of the Companies, Act 2013

**Consents**

Consents in writing of (a) Our Directors, Our Promoters, Our Company Secretary & Compliance Officer, Chief Financial Officer, Our Statutory Auditor, Our Peer Review Auditor, Our Banker to the Company; (b) Lead Manager, Registrar to the Offer, Banker(s) to the Offer, Legal Advisor to the Offer, Underwriter(s) to the Offer and Market Maker to the Offer to act in their respective capacities have been obtained as required as required under section 26 of the Companies Act, 2013 and shall be filed along with a copy of the Prospectus with the RoC, as required under Sections 32 of the Companies Act, 2013 and such consents will not be withdrawn up to the time of delivery of the Prospectus for registration with the RoC.

In accordance with the Companies Act and the SEBI (ICDR) Regulations, M/s Ashok Kanther & Associates., Chartered Accountants, Statutory Auditor and M/s. Mansaka Ravi & Associates, Peer Review Auditors of the Company has agreed to provide their written consent to the inclusion of their respective reports on Statement of Possible Tax Benefits relating to the possible tax benefits and restated financial statements as included in this Draft Prospectus/ Prospectus in the form and context in which they appear therein and such consent and reports will not be withdrawn up to the time of delivery of the Prospectus.

### Experts Opinion

Except for the reports in the section “Financial information of the Company” and “Statement of Tax Benefits” on page 157 and page 77 of this Prospectus from the Peer Review Auditors and Statutory Auditor respectively, our Company has not obtained any expert opinions. However, the term “expert” shall not be construed to mean an “expert” as defined under the U.S. Securities Act 1933.

### Expenses of the Offer

The total expenses of the Offer are estimated to be approximately ₹ 28.00 Lakhs, which is 1.41% of the Offer size. The estimated Offer related expenses include Offer Management Fee, underwriting and management fees SCSB’s commission/ Selling commission, fees, printing and distribution expenses, legal fees, statutory advertisement expenses, registrar and depository fees and listing fees. All expenses with respect to the Offer would be paid by our company and Selling Shareholders as applicable laws.

The Estimated Offer expenses are as under:-

(₹ in Rs.)			
Particulars	Expenses	As a % of total expenses	As a % of Offer
Payment to Merchant Banker including, underwriting and selling commissions, brokerages, payment to other intermediaries such as Legal Advisors, Bankers etc. and other out of pocket expenses*	21.00	75.00%	1.06%
Printing & Advertising Expenses	4.00	14.28%	0.20%
Statutory & Regulatory Fees and other expenses	3.00	10.72%	0.15%
<b>Total estimated Offer Expenses*</b>	<b>28.00</b>	<b>100.00%</b>	<b>1.41%</b>

\*Included Commission/ processing fees for SCSB, Brokerage and selling commission for Registered Brokers, RTA’s and CDPs

### Fees, Brokerage and Selling Commission payable to the LM

The total fees payable to the Lead Manager will be as per the (i) Agreement dated December 20, 2016 with the Selling shareholders and the Lead Manager Hem Securities Limited, (ii) the Underwriting Agreement dated January 31, 2017 with the Selling shareholders and Underwriter and (iii) the Market Making Agreement dated January 31, 2017 with the Selling shareholders and Market Maker, a copy of which is available for inspection at our Registered Office from 10.00 am to 5.00 pm on Working Days from the date of the Prospectus until the Offer Closing Date.

### Fees Payable to the Registrar to the Offer

The fees payable to the Registrar to the Offer for processing of applications, data entry, printing of CAN and printing of bulk mailing register will be as per the agreement between our Company and the Registrar to the Offer dated December 20, 2016 a copy of which is available for inspection at our Company’s Registered Office.

The Registrar to the Offer will be reimbursed for all out-of-pocket expenses including cost of stationery, postage, stamp duty, and communication expenses. Adequate funds will be provided to the Registrar to the Offer to enable it to send allotment advice by registered post/speed post.

### Particulars regarding Public or Rights Issues during the last five (5) years

Our Company has not made any previous public or rights issue in India or Abroad the five (5) years preceding the date of this Prospectus.

### **Previous issues of Equity Shares otherwise than for cash**

For detailed description please refer to section titled "Capital Structure" beginning on page 54 of this Prospectus.

### **Underwriting Commission, brokerage and selling commission on Previous Issues**

Since this is the initial public offering of our Company's Equity Shares, no sum has been paid or has been payable as commission or brokerage for subscribing for or procuring or agreeing to procure subscription for any of the Equity Shares since our incorporation.

### **Particulars in regard to our Company and other listed group-companies / subsidiaries/ associates under the same management within the meaning of Section 370(1B) of the Companies Act, 1956 / Section 186 of the Companies Act, 2013 which made any capital issue during the last three years:**

Except our Group Company, Madhya Bharat Agro Products Limited which had come out with the Initial Public Offer on SME platform of NSE during the year 2016, details of which is provided in the chapter titled "Our Group Companies" on page 148 of this Prospectus, neither our Company nor any of our other Group Companies which are under the same management within the meaning of section 370(1B) of the Companies Act, 1956 / Section 186 of the Companies Act, 2013, had made any public issue (including any rights issues or composite issues to the public) during the last three years.

### **Performance vis-a-vis objects – Public/right issue of our Company and /or listed Group Companies/ subsidiaries and associates of our Company**

Except as stated in the chapter titled "Capital Structure" beginning on page 54 of this Prospectus our Company has not undertaken any previous public or rights issue.

The Equity Shares of Madhya Bharat Agro Products Limited was listed pursuant to Offer for Sale by the existing shareholders, hence the Company did not receive any funds in the Initial Public Offer. The object of the offer was only to achieve the benefits of listing the Equity Shares on the Stock Exchange.

Other than as detailed above, none of the our Group Companies/ subsidiaries and associates of our Company has made Public Issue or Rights Issue of equity shares immediately preceding the date of filing of this Prospectus with the NSE.

### **Outstanding Debentures or Bond Issues or Redeemable Preference Shares**

Our Company does not have any outstanding debentures or bonds or Preference Redeemable Shares as on the date of filing this Prospectus.

### **Outstanding Convertible Instruments**

Our Company does not have any outstanding convertible instruments as on the date of filing this Prospectus.

### **Option to Subscribe**

Equity Shares being offered through the Prospectus can be applied for in dematerialized form only.

### **Stock Market Data of the Equity Shares**

This being an initial public offering of the Equity Shares of our Company, the Equity Shares are not listed on any Stock Exchanges.

### **Mechanism for Redressal of Investor Grievances**

The Agreement amongst the Registrar to the Offer, our Company provides for retention of records with the Registrar to the Offer for a period of at least three (3) year from the last date of dispatch of the letters of allotment, or demat credit, to enable the investors to approach the Registrar to the Offer for redressal of their grievances.

We hereby confirm that there is no investor complaints received during the three years preceding the filing of Prospectus. Since there is no investor complaints received, none are pending as on the date of filing of this Prospectus.

All grievances relating to the Offer may be addressed to the Registrar to the Offer, with a copy to the Compliance Officer and with a copy to the relevant Designated Intermediary with whom the Application Form was submitted.

The Applicants should give full details such as name of the sole/ first applicant, application Form number, DP ID, Client ID, PAN, date of the Application Form, address, number of the Equity Shares applied for and the name and address of the Designated Intermediary where the Application Form was submitted. Further, the Applicant shall also enclose the Acknowledgement Slip from the Designated Intermediaries in addition to the documents or information mentioned herein above.

### **Disposal of Investor Grievances by our Company**

Our Company estimates that the average time required by our Company or the Registrar to the Offer for the redressal of routine investor grievances shall be fifteen (15) Working Days from the date of receipt of the complaint. In case of complaints that are not routine or where external agencies are involved, our Company will seek to redress these complaints as expeditiously as possible.

Our Company has constituted Stakeholders Relationship Committee in the meeting of our Board of Directors held on December 20, 2016. For further details on the Stakeholders Relationship Committee, please refer to section titled "Our Management" beginning on page 127 of this Prospectus.

**Our Company has appointed Ms. Priyanka Bansal, Company Secretary, as the Compliance Officer to redress complaints, if any, of the investors participating in the Offer. Contact details for our Company Secretary and Compliance Officer are as follows:**

**Ms. Priyanka Bansal**  
**Krishana Phoschem Limited**  
5-O-20, Basement, Vyas Colony  
Bhilwara-311001, Rajasthan, India  
E-mail: [secretarial@krishnaphoschem.com](mailto:secretarial@krishnaphoschem.com)  
Website: [www.krishnaphoschem.com](http://www.krishnaphoschem.com)

Investors can contact the Compliance Officer or the Registrar in case of any pre- Offer or post-Offer related problems such as non-receipt of letters of allocation, credit of allotted Equity Shares in the respective beneficiary account etc.

Pursuant to the press release no. PR. No. 85/2011 dated June 8, 2011, SEBI has launched a centralized web based complaints redress system "SCORES". This would enable investors to lodge and follow up their complaints and track the status of redressal of such complaints from anywhere. For more details, investors are requested to visit the website [www.scores.gov.in](http://www.scores.gov.in)

### **Status of Investor Complaints**

We confirm that we have not received any investor complaint during the three years preceding the date of this Prospectus and hence there are no pending investor complaints as on the date of this Prospectus.

### **Disposal of investor grievances by listed companies under the same management as our Company**

For details, see the chapter "Our Group Companies" beginning on page 148 of this Prospectus.

### **Change in Auditors during the last three (3) years**

Except for appointment of M/s Mansaka Ravi & Associates, Chartered Accountants, as peer review auditor in addition to the existing auditors, there have been no changes in our Company's auditors in the last three (3) years.

### **Capitalization of Reserves or Profits**

Except as disclosed under section titled "Capital Structure" beginning on page 54 of this Prospectus, our Company has not capitalized its reserves or profits at any time during the last five (5) years.

### Revaluation of Assets

Our Company has not revalued its assets in five (5) years preceding the date of this Prospectus except as follows:-

S.No.	Particulars	Date of Revaluation	Amount (in Lacs)
1.	Land & Building, Plant & Machinery, Building	March 2011	1813.60
2.	Plant & Machinery, Land & Building	March 2014	2211.19

### Tax Implications

Investors who are allotted Equity Shares in the Offer will be subject to capital gains tax on any resale of the Equity Shares at applicable rates, depending on the duration for which the investors have held the Equity Shares prior to such resale and whether the Equity Shares are sold on the Stock Exchanges. For details, please refer the section titled "Statement of Tax Benefits" beginning on page 77 of this Prospectus.

### Purchase of Property

Other than as disclosed in Section "Our Business" on page 91 of the Prospectus, there is no property which has been purchased or acquired or is proposed to be purchased or acquired which is to be paid for wholly or partly from the proceeds of the present Offer or the purchase or acquisition of which has not been completed on the date of the Prospectus, other than property, in respect of which:-

The contract for the purchase or acquisition was entered into in the ordinary course of business, or the contract was entered into in contemplation of the Offer, or that the Offer was contemplated in consequence of the contract; or the amount of the purchase money is not material.

Except as stated elsewhere in the Prospectus, our Company has not purchased any property in which the Promoter and/or Directors have any direct or indirect interest in any payment made there under.

### Servicing Behavior

Except as stated in this Prospectus, there has been no default in payment of statutory dues or of interest or principal in respect of our borrowings or deposits.

### Payment or benefit to officers of Our Company

Except statutory benefits upon termination of their employment in our Company or superannuation, no officer of our Company is entitled to any benefit upon termination of his employment in our Company or superannuation.

**Except as disclosed in chapter titled "Our Management" beginning on page 127 and "Annexure Q – Statement of Related Party Transactions" beginning on page 185 of the Prospectus, none of the beneficiaries of loans and advances and sundry debtors are related to the Directors of our Company.**

## SECTION VII - OFFER RELATED INFORMATION

### TERMS OF THE OFFER

*The Equity Shares being offered are subject to the provisions of the Companies Act 2013, SCRR, 1957, SEBI (ICDR) Regulations, 2009, SCRR, the SEBI Listing Regulation our Memorandum and Articles of Association, the terms of this Prospectus, the Prospectus, the Abridged Prospectus, the Application Form, the Revision Form, the Confirmation of Allocation Note, SEBI (Listing Obligations and Disclosure Requirements) Regulations, 2015 and other terms and conditions as may be incorporated in the allotment advices and other documents/certificates that may be executed in respect of this Offer. The Equity Shares shall also be subject to laws as applicable, guidelines, notifications and regulations relating to the Offer of capital and listing and trading of securities issued from time to time by SEBI, the Government of India, the Stock Exchanges, the RBI, the FIPB, RoC and/or other authorities, as in force on the date of the Offer and to the extent applicable.*

*Please note that in terms of SEBI Circular CIR/CFD/POLICYCELL/11/2015 dated November 10, 2015, all the investors applying in this Offer shall use only Application Supported by Blocked Amount (ASBA) facility for making payment i.e. just writing their bank account numbers and authorising the banks to make payment in case of allotment by signing the application forms,*

#### **Authority for the Offer**

The present Offer of 65,76,000 Equity Shares has been authorized by a resolution of the Board of Directors of our Company at their meeting held on December 14, 2016 and was approved by the Shareholders of the Company by passing Special Resolution at the Extra Ordinary General Meeting held on December 19, 2016.

#### **Ranking of Equity Shares**

The Equity Shares being offered shall be subject to the provisions of the Companies Act, 2013 and our Memorandum and Articles of Association and shall rank pari-passu in all respects with the existing Equity Shares including in respect of the rights to receive dividends and other corporate benefits, if any, declared by us after the date of Allotment. For further details, please refer to “Main Provisions of the Articles of Association of the Company” beginning on page 294 of this Prospectus.

#### **Mode of Payment of Dividend**

The declaration and payment of dividend will be as per the provisions of Companies Act, the Articles of Association, the provisions of the SEBI (Listing Obligations and Disclosure Requirements) Regulations, 2015 and any other rules, regulations or guidelines as may be issued by the Government of India in connection thereto and recommended by the Board of Directors and the Shareholders at their discretion and will depend on a number of factors, including but not limited to earnings, capital requirements and overall financial condition of our Company. We shall pay dividends in cash and as per provisions of the Companies Act. For further details, please refer to the chapter titled “Dividend Policy” beginning on page 156 of this Prospectus.

#### **Face Value and Offer Price**

The Equity Shares having a Face Value of ₹10.00 each are being offered in terms of this Prospectus at the price of ₹ 30.00 per equity Share (including premium of ₹20.00 per equity share). The Offer Price is determined by our Company and Selling Shareholders in consultation with the Lead Manager and is justified under the section titled “Basis for Offer Price” on page 74 of this Prospectus. At any given point of time there shall be only one denomination of the Equity Shares of our Company, subject to applicable laws.

#### **Compliance with SEBI (ICDR) Regulations**

Our Company shall comply with all requirements of the SEBI ICDR Regulations. Our Company shall comply with all disclosure and accounting norms as specified by SEBI from time to time.

#### **Rights of the Equity Shareholders**

Subject to applicable laws, rules, regulations and guidelines and the Articles of Association, the equity shareholders shall have the following rights:

- Right to receive dividend, if declared;
- Right to receive Annual Reports & notices to members;
- Right to attend general meetings and exercise voting rights, unless prohibited by law;
- Right to vote on a poll either in person or by proxy, in accordance with the provisions of the Companies Act;
- Right to receive offer for rights shares and be allotted bonus shares, if announced;
- Right to receive surplus on liquidation, subject to any statutory and preferential claim being satisfied;
- Right of free transferability of the Equity Shares; subject to applicable laws including any RBI Rules and Regulations; and
- Such other rights, as may be available to a shareholder of a listed Public Limited Company under the Companies Act, terms of the SEBI (Listing Obligations and Disclosure Requirements) Regulations, 2015 and the Memorandum and Articles of Association of our Company.

For a detailed description of the main provisions of the Articles of Association of our Company relating to voting rights, dividend, forfeiture and lien, transfer, transmission and/or consolidation/splitting, please refer to Section titled “Main Provisions of Articles of Association” beginning on page 294 of this Prospectus.

### **Minimum Application Value, Market Lot and Trading Lot**

As per regulations made under and Section 29(1) of the Companies Act, 2013 the Equity Shares to be allotted must be in Dematerialized form i.e. not in the form of physical certificates but be fungible and be represented by the statement issued through electronic mode. Hence, the Equity Shares being offered can be applied for in the dematerialized form only.

The trading of the Equity Shares will happen in the minimum contract size of 4000 Equity Shares and the same may be modified by the SME Platform of NSE from time to time by giving prior notice to investors at large.

Allocation and allotment of Equity Shares through this offer document will be done in multiples of 4000 Equity Share subject to a minimum allotment of 4000 Equity Shares to the successful applicants in terms of the SEBI circular No. CIR/MRD/DSA/06/2012 dated February 21, 2012.

*Further, in accordance with Regulation 106(Q) of the SEBI (ICDR) Regulations the minimum application size in terms of number of specified securities shall not be less than Rupees One Lakh per application.*

### **Minimum Number of Allottees**

The minimum number of allottees in the Offer shall be 50 shareholders In case the number of prospective allottees is less than 50, no allotment will be made pursuant to this Offer and the amounts in the ASBA Account shall be unblocked forthwith.

### **Joint Holders**

Where two or more persons are registered as the holders of any Equity Shares, they will be deemed to hold such Equity Shares as joint-holders with benefits of survivorship.

### **Nomination Facility to Investor**

In accordance with Section 72 of the Companies Act, 2013, read with Companies (Share Capital and Debentures) Rules, 2014, the sole or first applicant, along with other joint applicant, may nominate any one person in whom, in the event of the death of sole Applicant or in case of joint applicant, death of all the applicants, as the case may be, the Equity Shares allotted, if any, shall vest. A person, being a nominee, entitled to the Equity Shares by reason of the death of the original holder(s), shall in accordance with Section 72 of the Companies Act, 2013, be entitled to the same advantages to which he or she would be entitled if he or she were the registered holder of the Equity Share(s). Where the nominee is a minor, the holder(s) may make a nomination to appoint, in the prescribed manner, any person to become entitled to Equity Share(s) in the event of his or her death during the minority. A nomination shall stand rescinded upon a sale of equity share(s) by the person nominating. A buyer will be entitled to make a fresh nomination in the manner prescribed. Fresh nomination can be made only on the prescribed form available on request at the Registered Office of our Company or to the Registrar and Transfer Agents of our Company.

In accordance with Section 72 of the Companies Act, 2013 any Person who becomes a nominee by virtue of Section 72 of the Companies Act, 2013 shall upon the production of such evidence as may be required by the Board, elect either:

- to register himself or herself as the holder of the Equity Shares; or
- to make such transfer of the Equity Shares, as the deceased holder could have made

Further, the Board may at any time give notice requiring any nominee to choose either to be registered himself or herself or to transfer the Equity Shares, and if the notice is not complied with within a period of ninety days, the Board may thereafter withhold payment of all dividends, bonuses or other moneys payable in respect of the Equity Shares, until the requirements of the notice have been complied with.

Since the allotment of Equity Shares in the Offer will be made only in dematerialized form, there is no need to make a separate nomination with our Company. Nominations registered with the respective depository participant of the applicant would prevail. If the investors require changing the nomination, they are requested to inform their respective depository participant.

## OFFER PROGRAMME

Event	Indicative Date
OFFER OPENING DATE	FEBRUARY 13, 2017
OFFER CLOSING DATE	FEBRUARY 16, 2017

## Minimum Subscription

In accordance with Regulation [106P] (1) of SEBI ICDR Regulations, this Offer is 100% underwritten. Also, in accordance with explanation to Regulation [106P] (1) of SEBI ICDR Regulations, the underwriting shall not be restricted to any minimum subscription level. This Offer is 100% underwritten and the details of the same have been disclosed under section titled “General Information” on page 46 of this Prospectus.

As per section 39 of the new Companies Act, if the “stated minimum amount” has not been subscribed and the sum payable on application is not received within a period of 30 days from the date of Issue of Prospectus, the application money has to be returned within such period as may be prescribed.

If our Company does not receive the subscription of 100% of the Offer through this Offer Document including devolvement of Underwriters within 60 (sixty) days from the date of closure of the Offer, our Company shall forthwith unblocked the entire subscription amount received. If there is a delay beyond 8 (eight) days after our Company becomes liable to pay the amount, our Company shall pay interest prescribed under section 73 of the Companies Act, 2013 and applicable law.

Further, in accordance with Regulation [106R] of SEBI ICDR Regulations, the minimum number of allottees in this Offer shall be fifty (50). In case the minimum number of prospective allottees is less than fifty (50), no allotment will be made pursuant to this Offer and the amounts in the ASBA Account shall be unblocked forthwith.

Further, in accordance with Regulation [106Q] of the SEBI (ICDR) Regulations the minimum application size in terms of number of specified securities shall not be less than Rupees One Lakh per application.

The Equity Shares have not been and will not be registered, listed or otherwise qualified in any other jurisdiction outside India and may not be offered or sold, and applications may not be made by persons in any such jurisdiction, except in compliance with the applicable laws of such jurisdiction.

## Arrangements for disposal of odd lots

The trading of the Equity Shares will happen in the minimum contract size of 4000 equity shares in terms of the SEBI circular No. CIR/MRD/DSA/06/2012 dated February 21, 2012. However, the Market Maker shall buy the entire shareholding of a shareholder in 1 (one) lot, where value of such shareholding is less than the minimum contract size allowed for trading on SME platform of NSE.

## Application by Eligible NRIs, FPIs/FIIs or VCFs registered with SEBI

It is to be understood that there is no reservation for Eligible NRIs, FPIs/FIIs or VCF registered with SEBI. Such Eligible NRIs, FPIs/FIIs or VCF registered with SEBI will be treated on the same basis with other categories for the purpose of Allocation.



**As per the extant policy of the Government of India, OCBs cannot participate in this Offer.**

NRIs, FPIs/FIIs and foreign venture capital investors registered with SEBI are permitted to purchase shares of an Indian company in a public offer without the prior approval of the RBI, so long as the price of the equity shares to be issued is not less than the price at which the equity shares are issued to residents. The transfer of shares between an Indian resident and a non-resident does not require the prior approval of the FIPB or the RBI, provided that (i) the activities of the investee company are under the automatic route under the foreign direct investment ("FDI") Policy and the non-resident shareholding is within the sectoral limits under the FDI policy; and (ii) the pricing is in accordance with the guidelines prescribed by the SEBI/RBI.

The current provisions of the Foreign Exchange Management (Transfer or Issue of Security by a Person Resident outside India) Regulations, 2000, provides a general permission for the NRIs, FPIs and foreign venture capital investors registered with SEBI to invest in shares of Indian companies by way of subscription in an IPO. However, such investments would be subject to other investment restrictions under the Foreign Exchange Management (Transfer or Issue of Security by a Person Resident outside India) Regulations, 2000, RBI and/or SEBI regulations as may be applicable to such investors.

The Allotment of the Equity Shares to Non-Residents shall be subject to the conditions, if any, as may be prescribed by the Government of India/RBI while granting such approvals.

**Restrictions on transfer and transmission of shares or debentures and on their consolidation or splitting**

Except for lock-in of the Pre- offer Equity Shares and Promoter minimum contribution in the Offer as detailed in the section titled "Capital Structure" beginning on page 54 of the Prospectus, and except as provided in the Articles of Association of our Company, there are no restrictions on transfers of Equity Shares. There are no restrictions on transfer and transmission of shares/ debentures and on their consolidation/ splitting except as provided in the Articles of Association. For further details please refer sub-heading "Main Provisions of the Articles of Association" on page 294 of the Prospectus.

*The above information is given for the benefit of the Applicants. The Applicants are advised to make their own enquiries about the limits applicable to them. Our Company and the Lead Managers do not accept any responsibility for the completeness and accuracy of the information stated hereinabove. Our Company, Selling Shareholders and the Lead Manager are not liable to inform the investors of any amendments or modifications or changes in applicable laws or regulations, which may occur after the date of this Prospectus. Applicants are advised to make their independent investigations and ensure that the number of Equity Shares Applied for do not exceed the applicable limits under laws or regulations.*

**Option to receive Equity Shares in Dematerialized Form**

As per Section 29(1) of the Companies Act, 2013 and in accordance with SEBI (ICDR) Regulations, every company making public offer shall issue securities only in dematerialized form only. Hence, the Equity Shares being offered can be applied for in the dematerialized form only. The investors have an option either to receive the security certificate or to hold the securities with depository. However, as per SEBI's circular RMB (compendium) series circular no. 2 (1999-2000) dated February 16, 2000, it has been decided by the SEBI that trading in securities of companies making an initial public offer shall be in dematerialized form only. The Equity Shares on Allotment will be traded only on the dematerialized segment of the SME Exchange. Applicants will not have an option of Allotment of the Equity Shares in physical form. Allottees shall have the option to re-materialise the Equity Shares, if they so desire, as per the provisions of the Companies Act, 2013 and the Depositories Act.

**Migration to Main Board**

In accordance with the NSE Circular dated November 26, 2012, our Company will have to be mandatorily listed and traded on the SME Platform of the NSE for a minimum period of two years from the date of listing and only after that it can migrate to the Main Board of the NSE as per the guidelines specified by SEBI and as per the procedures laid down under Chapter XB of the SEBI (ICDR) Regulations.

As per the provisions of the Chapter XB of the SEBI (ICDR) Regulation, 2009, our Company may migrate to the main board of NSE from the SME Exchange on a later date subject to the following:

- If the Paid up Capital of our Company is likely to increase above ₹ 25 Crores by virtue of any further issue of capital by way of rights, preferential issue, bonus issue etc. (which has been approved by a special resolution through postal ballot

wherein the votes cast by the shareholders other than the promoters in favour of the proposal amount to at least two times the number of votes cast by shareholders other than promoter shareholders against the proposal and for which our Company has obtained in-principal approval from the main board), we shall have to apply to NSE for listing our shares on its Main Board subject to the fulfillment of the eligibility criteria for listing of specified securities laid down by the Main Board

OR

- If the Paid-Up Capital of our Company is more than ₹ 10.00 Crore and up to ₹ 25.00 Crore, our company may still apply for migration to the Main Board If our Company fulfils the eligibility criteria for listing laid down by the Main Board of NSE and if the same has been approved by a special resolution through postal ballot wherein the votes cast by the shareholders other than the promoters in favour of the proposal amount to at least two times the number of votes cast by shareholders other than promoter shareholders against the proposal.

### Market Making

The Equity Shares offered through this Offer are proposed to be listed on the SME Platform of NSE, wherein the Lead Manager to this Offer shall ensure compulsory Market Making through the registered Market Makers of the SME Exchange for a minimum period of 3 (three) years from the date of listing on the SME Platform of NSE. For further details of the agreement entered into between our Company, the Lead Manager and the Market Maker please refer to section titled "General Information - Details of the Market Making Arrangements for this Offer" beginning on page 50 of this Prospectus.

In accordance with the SEBI Circular No.CIR/MRD/DSA/31/2012 dated November 27, 2012; it has been decided to make applicable limits on the upper side for the Market Makers during market making process taking into consideration the Offer size in the following manner:

Offer size	Buy quote exemption threshold (including mandatory initial inventory of 5% of Offer size)	Re-entry threshold for buy quotes (including mandatory initial inventory of 5% of Offer size)
Upto Rs. 20 Crore	25%	24%
₹ 20 to ₹ 50 Crore	20%	19%
₹ 50 to ₹ 80 Crore	15%	14%
Above ₹ 80 Crore	12%	11%

Further, the Market Maker shall give (2) Two way quotes till it reaches the upper limit threshold; thereafter it has the option to give only sell quotes. Two (2) way quotes shall be resumed the moment inventory reaches the prescribed re-entry threshold.

In view of the Market Maker obligation, there shall be no exemption/threshold on downside. However, in the event the Market Maker exhausts its inventory through market making process on the platform of the exchange, the concerned stock exchange may intimate the same to SEBI after due verification.

### New Financial Instruments

There are no new financial instruments such as deep discounted bonds, debenture, warrants, secured premium notes, etc. issued by our Company through this Offer.

### Jurisdiction

Exclusive jurisdiction for the purpose of this Offer is with the competent courts / authorities in Jaipur, Rajasthan, India.

The Equity Shares have not been and will not be registered under the U.S. Securities Act or any state securities laws in the United States, and may not be offered or sold within the United States to, or for the account or benefit of "U.S. persons" (as defined in Regulation S), except pursuant to an exemption from or in a transaction not subject to, registration requirements of the U.S. Securities Act and applicable U.S. state Securities laws. Accordingly, the Equity Shares are only being offered or sold outside the

United States in compliance with Regulation S under the Securities Act and the applicable laws of the jurisdictions where those offers and sales occur.

The Equity Shares have not been and will not be registered, listed or otherwise qualified in any other jurisdiction outside India and may not be offered or sold, and applications may not be made by persons in any such jurisdiction, except in compliance with the applicable laws of such jurisdiction.

### OFFER STRUCTURE

The Public Offer of 65,76,000 Equity Shares of ₹ 10 each for cash at a price of ₹ 30.00 per Equity Share (including a share premium of ₹ 20.00 per Equity Share) aggregating upto ₹ 1972.80 Lacs (the “Offer”) by our Company of which 3,36,000 Equity Shares of ₹ 10 each will be reserved for subscription by Market Makers to the Offer (“Market Maker Reservation Portion”) the Offer less the Market Maker Reservation Portion i.e. Offer of 62,40,000 Equity Shares of ₹ 10 each is hereinafter referred to as the “Net Offer”. The Offer and the Net Offer will constitute 26.41% and 25.06%, respectively of the post Offer paid up Equity Share capital of the Company.

The Public Offer includes an offer for sale of 65,76,000 Equity Shares of ₹ 10 each for cash at a price ₹ 30.00 of per Equity Share (including a share premium of ₹ 20.00 per Equity Share) aggregating upto 1972.80 Lacs (the “Offer for Sale”)

The Offer is made through the Fixed Price Offer Process.

Particulars	Net Offer to Public	Market Maker Reservation Portion
<b>Number of Equity Shares*</b>	62,40,000 Equity Shares.	3,36,000 Equity Shares
<b>Percentage of the Offer Size available for allocation</b>	94.89% of the Offer	5.11% of the Offer
<b>Basis of Allocation, if respective category is oversubscribed</b>	Proportionate, subject to minimum allotment of 4000 Equity Shares and further allotment in multiples of 4000 Equity Shares each. For further details refer page 283 of the Prospectus.	Firm Allotment
<b>Mode of Application</b>	Through ASBA Process only	
<b>Mode of Allotment</b>	Compulsorily in dematerialized form	
<b>Minimum Application</b>	<b><u>For Other than Retail Individual Investors:-</u></b>	3,36,000 Equity Shares
	Such nos. of Equity Shares in multiples of 4000 Equity Shares at an Offer Price of ₹ 30.00 such that the application value exceeds ₹ Rs. 2 lacs	
	<b><u>For Retail Investors:-</u></b>	
	4000 Equity Shares	
<b>Maximum Application</b>	<b><u>For Other than Retail Individual Investors:-</u></b>	3,36,000 Equity Shares
	Such nos. of Equity Shares in multiples of 4000 Equity Shares such that the application size does not exceeds the Offer, subject to applicable limit.	
	<b><u>For Retail Investors:-</u></b>	
	4000 Equity Shares	
<b>Trading Lot</b>	4000 Equity Shares	4000 Equity Shares. However the Market Makers may accept odd lots if any in the market as required under the SEBI (ICDR) Regulations, 2009.
<b>Application Lot Size</b>	4000 Equity Shares thereafter Equity Shares and in multiples of 4000 Equity Shares	
<b>Terms of Payment</b>	The entire Application Amount will be payable at the time of submission of the Application Form	

This Offer is being made in terms of Chapter XB of the SEBI (ICDR) Regulations, 2009, as amended from time to time. For further details please refer to “Offer Structure” on page 250 of the Prospectus.

\*As per Regulation 43(4) of the SEBI (ICDR) Regulations, as amended, as present Offer is a fixed price offer ‘the allocation’ is the net Offer to the public category shall be made as follows:

- a) Minimum fifty percent to retail individual investors; and
- b) Remaining to
  - (i) Investors other than retail Individual Investors; and
  - (ii) Other investors including corporate bodies or institutions, irrespective of the number of specified securities applied for;
- c) The unsubscribed portion in either of the categories specified in (a) or (b) above may be allocated to the applicants in the other category.

If the retail individual investor category is entitled to more than fifty percent on proportionate basis, accordingly the retail individual investors shall be allocated that higher percentage.

**Withdrawal of the Offer**

Our Company and selling shareholders, in consultation with the Lead Manager, reserves the right not to proceed with the Offer at any time before the Offer Opening Date, without assigning any reason thereof.

In case, the Company and selling shareholders, wish to withdraw the Offer after Offer Opening but before allotment, the Company and selling shareholders will give public notice giving reasons for withdrawal of Offer. The public notice will appear in two widely circulated national newspapers (one each in English and Hindi) and one in regional newspaper.

The Lead Manager, through the Registrar to the Offer, will instruct the SCSBs, to unblock the ASBA Accounts within one Working Day from the day of receipt of such instruction. The notice of withdrawal will be issued in the same newspapers where the pre-offer advertisements have appeared and the Stock Exchange will also be informed promptly.

If the Company and selling shareholders withdraw the Offer after the Offer Closing Date and subsequently decides to undertake a public offering of Equity Shares, the Company will file a fresh Draft Prospectus with the stock exchange where the Equity Shares may be proposed to be listed.

Notwithstanding the foregoing, the Offer is subject to obtaining (i) the final listing and trading approvals of the Stock Exchange, which our Company will apply for only after Allotment; and (ii) the final RoC approval to the Prospectus after it is filed with the RoC.

**Offer Programme**

<b>OFFER OPENING DATE</b>	<b>FEBRUARY 13, 2017</b>
<b>OFFER CLOSING DATE</b>	<b>FEBRUARY 16, 2017</b>

Applications and any revisions to the same will be accepted only between 10.00 a.m. to 5.00 p.m. (Indian Standard Time) during the Offer Period at the Application Centers mentioned in the Application Form.

Standardization of cut-off time for uploading of applications on the Offer closing date:

- a) A standard cut-off time of 3.00 p.m. for acceptance of applications.
- b) A standard cut-off time of 4.00 p.m. for uploading of applications received from other than retail individual applicants.
- c) A standard cut-off time of 5.00 p.m. for uploading of applications received from only retail individual applicants, which may be extended up to such time as deemed fit by NSE after taking into account the total number of applications received up to the closure of timings and reported by LM to NSE within half an hour of such closure.

It is clarified that Bids not uploaded in the book, would be rejected. In case of discrepancy in the data entered in the electronic book vis-à-vis the data contained in the physical Bid form, for a particular bidder, the details as per physical application form of that Bidder may be taken as the final data for the purpose of allotment.

Applications will be accepted only on Working Days, i.e., Monday to Friday (excluding any public holiday).

## OFFER PROCEDURE

All applicants should review the General Information Document for Investing in Public Issues prepared and issued in accordance with the circular (CIR/CFD/DIL/12/2013) dated October 23, 2013 notified by SEBI (“General Information Document”) **included below under section “-PART B – General Information Document”**, which highlights the key rules, processes and procedures applicable to public issues in general in accordance with the provisions of the Companies Act 2013 (to the extent notified), the Companies Act, 1956 (to the extent not repealed by the Companies Act, 2013), the Securities Contracts (Regulation) Act, 1956, the Securities Contracts (Regulation) Rules, 1957 and the SEBI ICDR Regulations as amended. The General Information Document has been updated to include reference to the Securities and Exchange Board of India (Foreign Portfolio Investors) Regulations, 2014, SEBI Listing Regulations 2015 and certain notified provisions of the Companies Act, 2013, to the extent applicable to a public Company. The General Information Document is also available on the websites of the Stock Exchanges and the Lead Manager. Please refer to the relevant portions of the General Information Document which are applicable to this Offer.

Pursuant to the Securities and Exchange Board of India (Issue of Capital and Disclosure Requirements)(Fifth Amendment)Regulations, 2015, there have been certain changes in the offer procedure for initial public offerings including making ASBA Process mandatory for all investors, allowing registrar, share transfer agents, collecting depository participants and stock brokers to accept Application forms. Further, SEBI, by its circular No. (CIR/CFD/POLICYCELL/11/2015) dated November 10, 2015, reduced the time taken for listing after the closure of an offer to six working days.

**Please note that the information stated/ covered in this section may not be complete and/or accurate and as such would be subject to modification/change.** Our Company, the Selling Shareholders and the Lead Manager do not accept any responsibility for the completeness and accuracy of the information stated in this section and the General Information Document. Applicants are advised to make their independent investigations and ensure that their Applications do not exceed the investment limits or maximum number of Equity Shares that can be held by them under applicable law or as specified in this Prospectus and Prospectus.

This section applies to all the Applicants, please note that all the applicants are required to make payment of the full Application Amount along with the Application Form.

**Our Company, Selling Shareholders and the LM are not liable for any amendments, modifications or change in applicable laws or regulations, which may occur after the date of this Prospectus.**

## PART-A

### FIXED PRICE OFFER PROCEDURE

The Offer is being made under Regulation 106(M) (2) of Chapter XB of SEBI (Issue of Capital and Disclosure Requirements) Regulations, 2009 via Fixed Price Process.

Applicants are required to submit their Applications to the Designated Intermediaries. In case of QIB Applicants, our Company in consultation with the Lead Manager may reject Applications at the time of acceptance of Application Form provided that the reasons for such rejection shall be provided to such Applicant in writing.

In case of Non-Institutional Applicants and Retail Individual Applicants, our Company would have a right to reject the Applications only on technical grounds.

Investors should note that according to section 29(1) of the Companies Act, 2013, allotment of Equity Shares to all successful Applicants will only be in the dematerialized form. Applicants will not have the option of being Allotted Equity Shares in physical form. The Equity Shares on allotment shall be traded only in the dematerialized segment of the Stock Exchanges, as mandated by SEBI.

### APPLICATION FORM

Pursuant to SEBI Circular dated November 10, 2015 and bearing Reference No. CIR/CFD/POLICYCELL/11/2015 which shall be applicable for all public issues opening on or after January 01, 2016, all the investors can apply through ASBA Mode. The prescribed colour of the Application Form for various categories applying in this Offer is as follows:

Category	Colour
Indian Public / eligible NRI's applying on a non-repatriation basis (ASBA)	White
Non-Residents including eligible NRI's, FPI's, FIIs, FVCIs, etc. applying on a repatriation basis (ASBA)	Blue

Applicants shall only use the specified Application Form for the purpose of making an Application in terms of this Prospectus. An Investor, intending to subscribe to this Offer, shall submit a completed application form to any of the following Intermediaries (Collectively called “*Designated Intermediaries*”)

Sr. No.	Designated Intermediaries
1.	An SCSB, with whom the bank account to be blocked, is maintained
2.	A syndicate member (or sub-syndicate member)
3.	A stock broker registered with a recognized stock exchange (and whose name is mentioned on the website of the stock exchange as eligible for this activity) (‘broker’)
4.	A depository participant (‘DP’) (whose name is mentioned on the website of the stock exchange as eligible for this activity)
5.	A registrar to an offer and share transfer agent (‘RTA’) (whose name is mentioned on the website of the stock exchange as eligible for this activity)

*The aforesaid intermediary shall, at the time of receipt of application, give an acknowledgement to investor, by giving the counter foil or specifying the application number to the investor, as proof of having accepted the application form, in physical or electronic mode, respectively.*

The upload of the details in the electronic bidding system of stock exchange will be done by:

<b>For Applications submitted by investors to SCSB:</b>	After accepting the form, SCSB shall capture and upload the relevant details in the electronic bidding system as specified by the stock exchange and may begin blocking funds available in the bank account specified in the form, to the extent of the application money specified.
<b>For applications submitted by investors to intermediaries other than SCSBs:</b>	After accepting the application form, respective Intermediary shall capture and upload the relevant details in the electronic bidding system of the stock exchange. Post uploading, they shall forward a schedule as per prescribed format along with the application forms to designated branches of the respective SCSBs for blocking of funds within one day of closure of Offer.

Applicants shall submit an Application Form either in physical or electronic form to the SCSB's authorizing blocking funds that are available in the bank account specified in the Application Form used by ASBA Applicants.

#### Availability of Prospectus and Application Forms

The Application Forms and copies of the Prospectus may be obtained from the Registered Office of our Company, Lead Manager to the Offer, and Registrar to the Offer, as mentioned in the Application Form. The application forms may also be downloaded from the website of NSE Limited i.e. [www.nseindia.com](http://www.nseindia.com)

#### Who can Apply?

In addition to the category of Applicants as set forth under —Part B - General Information Document for Investing in Public Issues-Category of Investors Eligible to participate in an Offer”, the following persons are also eligible to invest in the Equity Shares under all applicable laws, regulations and guidelines, including:

- FPIs and sub-accounts registered with SEBI other than Category III foreign portfolio investor;
- Category III foreign portfolio investors, which are foreign corporate or foreign individuals only under the Non-Institutional Investors category;
- Scientific and / or industrial research organizations authorized in India to invest in the Equity Shares.

- Any other persons eligible to apply in this Offer under the laws, rules, regulations, guidelines and policies applicable to them.

#### **Applications not to be made by:**

1. Minors (except through their Guardians)
2. Partnership firms or their nominations
3. Foreign Nationals (except NRIs)
4. Overseas Corporate Bodies

The information below is given for the benefit of the applicants. Our Company, Selling Shareholders and the Lead Manager do not accept responsibility for the completeness and accuracy of the information stated. Our Company, Selling Shareholders and the Lead Manager is not liable for any amendments or modification or changes in applicable laws or regulations, which may occur after the date of the Prospectus. Applicants are advised to make their independent investigations and ensure that the number of Equity Shares applied for does not exceed the limits prescribed under laws or regulations.

#### **MAXIMUM AND MINIMUM APPLICATION SIZE**

##### **1. For Retail Individual Applicants**

The Application must be for a minimum of 4000 Equity Shares and in multiples of 4000 Equity Shares thereafter, so as to ensure that the Application Price payable by the Applicant does not exceed Rs. 2,00,000. In case of revision of Applications, the Retail Individual Applicants have to ensure that the Application Price does not exceed Rs. 2,00,000.

##### **2. For Other than Retail Individual Applicants (Non-Institutional Applicants and QIBs):**

The Application must be for a minimum of such number of Equity Shares that the Application Amount exceeds Rs. 2,00,000 and in multiples of 4000 Equity Shares thereafter. An Application cannot be submitted for more than the Net Offer Size. However, the maximum Application by a QIB investor should not exceed the investment limits prescribed for them by applicable laws. Under existing SEBI Regulations, a QIB Applicant cannot withdraw its Application after the Offer Closing Date and is required to pay 100% QIB Margin upon submission of Application.

In case of revision in Applications, the Non-Institutional Applicants, who are individuals, have to ensure that the Application Amount is greater than Rs. 2,00,000 for being considered for allocation in the Non-Institutional Portion.

**Applicants are advised to ensure that any single Application form them does not exceed the investment limits or maximum number of Equity Shares that can be held by them under applicable law or regulation or as specified in this Prospectus.**

**The above information is given for the benefit of the applicants. The Company, Selling Shareholders and the LMs are not liable for any amendments or modification or changes in applicable laws or regulations, which may occur after the date of this Prospectus. Applicants are advised to make their independent investigations and ensure that the number of Equity Shares applied for do not exceed the applicable limits under laws or regulations.**

#### **PARTICIPATION BY ASSOCIATES /AFFILIATES OF LM AND THE SYNDICATE MEMBERS**

The LM and Syndicate Members, if any shall not be entitled to subscribe to this Offer in any manner except towards fulfilling their underwriting and market making obligations. However, associates/affiliates of the LM and Syndicate Members, if any may subscribe for Equity Shares in the Offer, either in the QIB Category or in the Non- Institutional Category as may be applicable to the applicants, where the allocation is on a proportionate basis and such subscription may be on their own account or on behalf of their clients.

#### **Option to Subscribe in the Offer**

- a. As per Section 29(1) of the Companies Act 2013, allotment of Equity Shares shall be dematerialized form only. Investors will not have the option of getting allotment of specified securities in physical form.



- b. The Equity Shares, on allotment, shall be traded on the Stock Exchange in demat segment only.
- c. A single application from any investor shall not exceed the investment limit/minimum number of Equity Shares that can be held by him/her/it under the relevant regulations/statutory guidelines and applicable law.

### **Information for the Applicants**

1. Our Company, Selling Shareholders and the Lead Managers shall declare the Offer Opening Date and Offer Closing Date in the Prospectus to be registered with the RoC and also publish the same in two national newspapers (one each in English and Hindi) and in a regional newspaper with wide circulation. This advertisement shall be in prescribed format.
2. Our Company will file the Prospectus with the RoC at least 3 (three) days before the Offer Opening Date.
3. Copies of the Application Form along with Abridge Prospectus and copies of the Prospectus will be available with the, the Lead Managers, the Registrar to the Offer, and at the Registered Office of our Company. Electronic Application Forms will also be available on the websites of the Stock Exchange.
4. Any applicant who would like to obtain the Prospectus and/ or the Application Form can obtain the same from our Registered Office / Corporate Office.
5. Applicants who are interested in subscribing for the Equity Shares should approach Designated Intermediaries to register their applications.
6. Application Forms submitted directly to the SCSBs should bear the stamp of the SCSBs and/or the Designated Branch, or the respective Designated Intermediaries. Application Form submitted by Applicants whose beneficiary account is inactive shall be rejected.
7. The Application Form can be submitted either in physical or electronic mode, to the SCSBs with whom the ASBA Account is maintained, or other Designated Intermediaries (Other than SCSBs). SCSBs may provide the electronic mode of collecting either through an internet enabled collecting and banking facility or such other secured, electronically enabled mechanism for applying and blocking funds in the ASBA Account.
8. Applicants applying directly through the SCSBs should ensure that the Application Form is submitted to a Designated Branch of SCSB, where the ASBA Account is maintained. Applications submitted directly to the SCSBs or other Designated Intermediaries (Other than SCSBs), the relevant SCSB, shall block an amount in the ASBA Account equal to the Application Amount specified in the Application Form, before entering the ASBA application into the electronic system.
9. Except for applications by or on behalf of the Central or State Government and the Officials appointed by the courts and by investors residing in the State of Sikkim, the Applicants, or in the case of application in joint names, the first Applicant (the first name under which the beneficiary account is held), should mention his/her PAN allotted under the Income Tax Act. In accordance with the SEBI Regulations, the PAN would be the sole identification number for participating transacting in the securities market, irrespective of the amount of transaction. Any Application Form without PAN is liable to be rejected. The demat accounts of Applicants for whom PAN details have not been verified, excluding persons resident in the State of Sikkim or persons who may be exempted from specifying their PAN for transacting in the securities market, shall be "suspended for credit" and no credit of Equity Shares pursuant to the Offer will be made into the accounts of such Applicants.
10. The Applicants may note that in case the PAN, the DP ID and Client ID mentioned in the Application Form and entered into the electronic collecting system of the Stock Exchange Designated Intermediaries do not match with PAN, the DP ID and Client ID available in the Depository database, the Application Form is liable to be rejected.

### **Application by Indian Public including eligible NRIs applying on Non-Repatriation Basis**

Application must be made only in the names of individuals, Limited Companies or Statutory Corporations/institutions and not in the names of Minors, Foreign Nationals, Non Residents Indian (except for those applying on non-repatriation), trusts, (unless the

Trust is registered under the Societies Registration Act, 1860 or any other applicable Trust laws and is authorized under its constitution to hold shares and debentures in a Company), Hindu Undivided Families, Partnership firms or their nominees. In case of HUFs, application shall be made by the Karta of the HUF. An applicant in the Net Public Category cannot make an application for that number of Equity Shares exceeding the number of Equity Shares offered to the public. Eligible NRIs applying on a non-repatriation basis should authorize their SCSB to block their NRE/FCNR accounts as well as NRO accounts.

**Applications by eligible NRIs/ FPI's on Repatriation Basis**

Application Forms have been made available for eligible NRIs at our registered office.

Eligible NRIs applicants may please note that only such applications as are accompanied by payment in free foreign exchange shall be considered for Allotment under reserved category. The Eligible NRIs who intend to get the amount blocked in the Non Resident Ordinary (NRO) accounts shall use the form meant for Resident Indians and shall not use the forms meant for reserved category.

Under FEMA, general permission is granted to companies vide notification no. FEMA/20/2000 RB dated 03/05/2000 to issue securities to NRIs subject to the terms and conditions stipulated therein. Companies are required to file the declaration in the prescribed form to the concerned Regional Office of RBI within 30 days from the date of issue of shares of allotment to NRIs on repatriation basis.

Allotment of Equity shares to Non-Resident Indians shall be subject to the prevailing Reserve Bank of India Guidelines. Sale proceeds of such investments in Equity shares will be allowed to be repatriated along with the income thereon subject to the permission of the RBI and subject to the Indian Tax Laws and regulations and any other applicable laws.

**As Per The Current Regulations, The Following Restrictions Are Applicable For Investments By FPIs.**

1. A foreign portfolio investor shall invest only in the following securities, namely- (a) Securities in the primary and secondary markets including shares, debentures and warrants of companies, listed or to be listed on a recognized stock exchange in India; (b) Units of schemes floated by a domestic mutual funds, whether listed on a recognized stock exchange or not; (c) Units of Schemes floated by a collective investment scheme; (d) Derivatives traded on a recognized Stock Exchange; (e) Treasury bills and dated government securities; (f) Commercial papers issued by an Indian Company; (g) Rupee denominated credit enhanced bonds; (h) Security receipts issued by asset reconstruction companies; (i) Perpetual debt instruments and debt capital instruments, as specified by the Reserve Bank of India from time to time; (j) Listed and unlisted non-convertible debentures/bonds issued by an Indian company in the infrastructure sector, where 'infrastructure' is defined in terms of the extant External Commercial Borrowings (ECB) guidelines; (k) Non-Convertible debentures or bonds issued by Non – Banking Financial Companies categorized as 'Infrastructure Finance Companies' (IFC) by the Reserve Bank of India; (l) Rupee denominated bonds or units issued by infrastructure debt funds; (m) Indian depository receipts; and (n) Such other instruments specified by the Board from time to time.
2. Where a foreign institutional investor or a sub account, prior to commencement of SEBI (Foreign Portfolio Investors) Regulations, 2014, hold equity shares in a company whose shares are not listed on any recognized stock exchange, and continues to hold such shares after Initial Public Offering and listing thereof, such shares shall be subject to lock-in for the same period, if any, as is applicable to shares held by a foreign direct investor placed in similar position, under the policy of the Government of India relating to foreign direct investment from the time being in force.
3. In respect of investments in the secondary market, the following additional conditions shall apply:
  - a) A foreign portfolio investor shall transact in the securities in India only on the basis of taking and giving delivery of securities purchased or sold;
  - b) Nothing contained in clause (a) shall apply to:
    - ❖ Any transactions in derivatives on a recognized stock exchange;
    - ❖ Short selling transactions in accordance with the framework specified by the Board;
    - ❖ Any transaction in securities pursuant to an agreement entered into with the merchant banker in the process of market making or subscribing to unsubscribed portion of the Offer in accordance with Chapter XB of the Securities and Exchange Board of India (Issue of Capital and Disclosure Requirements) Regulations, 2009

- ❖ Any other transaction specified by the Board.
- c) No transaction on the stock exchange shall be carried forward;
  - d) The transaction of business in securities by a foreign portfolio investor shall be only through stock brokers registered by the Board; provided nothing contained in this clause shall apply to;
    - i. transactions in Government securities and such other securities falling under the purview of the Reserve Bank of India which shall be carried out in the manner specified by the Reserve Bank of India;
    - ii. Sale of securities in response to a letter of offer sent by an acquirer in accordance with the Securities and Exchange Board of India (Substantial Acquisition of Shares and Takeovers) Regulations, 2011;
    - iii. Sale of securities in response to an offer made by any promoter or acquirer in accordance with the Securities and Exchange Board of India (Delisting of Equity Shares) Regulations, 2009;
    - iv. Sale of securities, in accordance with the Securities and Exchange Board of India (Buy Back of Securities) Regulations, 1998;
    - v. divestment of securities in response to an offer by Indian Companies in accordance with Operative Guidelines of Disinvestment of shares of Indian Companies in the overseas market through issue of American Depository Receipts or Global Depository Receipts as notified by the Government of India and directions issued by Reserve Bank of India from time to time;
    - vi. Any bid for, or acquisition of, securities in response to an offer for disinvestment of shares made by the Central Government or any State Government;
    - vii. Any transaction in securities pursuant to an agreement entered into with merchant banker in the process of market making portion of the issue in accordance with Chapter XB of the Securities and Exchange Board of India ( Issue of Capital and Disclosure Requirements) Regulations, 2009;
    - viii. Any other transaction specified by Board.
  - e) A foreign portfolio investor shall hold, deliver or cause to be delivered securities only in dematerialized form: Provided that any shares held in non-dematerialized form, before the commencement of these regulation, can be held in non-dematerialized form, if such shares cannot be dematerialized.
4. Unless otherwise approved by the Board, securities shall be registered in the name of the foreign portfolio investor as a beneficial owner for the purposes of the Depositories Act, 1996.
  5. The purchase of Equity Shares of each company by a single foreign portfolio investor or an investor group shall be below ten percent of the total issued capital of the company.
  6. The investment by the foreign portfolio investor shall also be subject to such other conditions and restrictions as may be specified by the Government of India from time to time.
  7. In cases where the Government of India enters into agreements or treaties with other sovereign Governments and where such agreements or treaties specifically recognize certain entities to be distinct and separate, the Board may, during the validity of such agreements or treaties, recognize them as such, subject to conditions as may be specified by it.
  8. A foreign portfolio investor may lend or borrow securities in accordance with the framework specified by the Board in this regard.

No foreign portfolio investor may issue, subscribe to or otherwise deal in offshore derivative instruments, directly or indirectly, unless the following conditions are satisfied:

- a) Such offshore derivative instruments are issued only to persons who are regulated by an appropriate foreign regulatory authority'
- b) Such offshore derivatives instruments are issued after compliance with 'know your client' norms:

Provided that those unregulated broad based funds, which are classified as Category II foreign portfolio investor by virtue of their investment manager being appropriately regulated shall not issue, subscribe or otherwise deal, in offshore derivatives instruments directly or indirectly.

Provided further that no Category III foreign portfolio investor shall issue, subscribe to or otherwise deal in offshore derivatives instruments directly or indirectly.

A foreign portfolio investor shall ensure that further issue or transfer of any offshore derivative instruments issued by or on behalf of it is made only to persons who are regulated by an appropriate foreign regulatory authority.

Foreign portfolio investors shall fully disclose to the Board any information concerning the terms of and parties to off-shore derivative instruments such as participatory notes, equity linked notes or any other such instruments, by whatever names they are called, entered into by it relating to any securities listed or proposed to be listed in any stock exchange in India, as and when and in such form as the Board may specify.

Any offshore derivative instruments issued under the Securities and Exchange Board of India of India (Foreign Institutional Investors) Regulations, 1995 before commencement of SEBI (Foreign Portfolio Investors) Regulation, 2014 shall be deemed to have been issued under the corresponding provision of SEBI (Foreign Portfolio Investors) Regulation, 2014.

The purchase of equity shares of each company by a single foreign portfolio investor or an investor group shall be below 10 per cent of the total issued capital of the company.

An FII or its subaccount which holds a valid certificate of registration shall, subject to the payment of conversion fees, be eligible to continue to buy, sell or otherwise deal in securities till the expiry of its registration as a foreign institutional investor or sub-account, or until he obtains a certificate of registration as foreign portfolio investor, whichever is earlier.

Qualified foreign investor may continue to buy, sell or otherwise deal in securities subject to the provision of SEBI (Foreign Portfolio Investors) Regulation, 2014, for a period of one year from the date of commencement of aforesaid regulations, or until it obtains a certificate of registration as foreign portfolio investor, whichever is earlier.

#### **Application by Mutual Funds**

As per the current regulations, the following restrictions are applicable for investments by Mutual fund:

No mutual fund scheme shall invest more than 10% of its net asset value in the Equity Shares or equity related instruments of any Company provided that the limit of 10% shall not be applicable for investments in index funds or sector or industry specific funds. No mutual fund under all its schemes should own more than 10% of any Company's paid up share capital carrying voting rights.

With respect to Applications by Mutual Funds, a certified copy of their SEBI registration certificate must be lodged with the Application Form. Failing this, our Company reserves the right to accept or reject any Application in whole or in part, in either case, without assigning any reason thereof.

In case of a Mutual Fund, a separate Application can be made in respect of each scheme of the Mutual Fund registered with SEBI and such Applications in respect of more than one scheme of the Mutual Fund will not be treated as multiple Applications provided that the Applications clearly indicate the scheme concerned for which the Application has been made.

The Application made by Asset Management Companies or custodians of Mutual Funds shall specifically state the names of the concerned schemes for which the Applications are made.

#### **Applications by Limited Liability Partnerships**

In case of application made by limited liability partnerships registered under the Limited Liability Partnership Act, 2008, a certified copy of certificate of registration issued under the LLP Act, 2008 must be attached to the Application Form. Failing this, our Company and Selling Shareholders reserves the right to reject any application without assigning any reason thereof.

#### **Applications by Insurance Companies**

In case of application made by insurance companies registered with IRDA, certified copy of certificate of registration issued by IRDA must be attached to the Application Form. Failing this, our Company, Selling Shareholders in consultation with the LM, reserves the right to reject any application, without assigning any reason thereof.

The exposure norms for insurers, prescribed under the Insurance Regulatory and Development Authority (Investment Scheme) (5th Amendment) Regulations, 2010, as amended (the “IRDA Investment Regulations”), are broadly set forth below:

- (a) Equity shares of a company: The lesser of 10% of the investee company’s subscribed capital (face value) or 10% of the respective fund in case of life insurer or 10% of investment assets in case of general insurer or reinsurer;
- (b) The entire group of the investee company: at least 10% of the respective fund in case of a life insurer or 10% of investment assets in case of general insurer or reinsurer (25% in case of Unit Linked Insurance Plans); and
- (c) The industry sector in which the investee company operates: 10% of the insurer’s total investment exposure to the industry sector (25% in case of Unit Linked Insurance Plans).

### **Applications under Power of Attorney**

In case of applications made pursuant to a power of attorney by limited companies, corporate bodies, registered societies, FIIs, FPI’s, Mutual Funds, insurance companies and provident funds with minimum corpus of Rs. 2,500 Lakhs (subject to applicable law) and pension funds with a minimum corpus of Rs. 2,500 Lakhs, a certified copy of the power of attorney or the relevant Resolution or authority, as the case may be, along with a certified copy of the memorandum of association and articles of association and/or bye laws must be lodged with the Application Form. Failing this, our Company reserves the right to accept or reject any application in whole or in part, in either case, without assigning any reason therefore.

With respect to the applications by VCFs, FVCIs and FPIs, a certified copy of the power of attorney or the relevant resolution or authority, as the case may belong with a certified copy of their SEBI registration certificate must be lodged along with the Application Form. Failing this, our Company reserves the right to accept or reject any application in whole or in part, in either case, without assigning any reason therefore.

In the case of Applications made pursuant to a power of attorney by Mutual Funds, a certified copy of the power of attorney or the relevant resolutions or authority, as the case may be, along with the certified copy of their SEBI registration certificate must be submitted along with the Application Form. Failing this, the Company reserves the right to accept or reject any Application in whole or in part, in either case, without assigning any reason therefore.

In the case of Applications made by insurance companies registered with the IRDA, a certified copy of certificate of registration issued by the IRDA must be lodged along with the Application Form. Failing this, the Company reserves the right to accept or reject any Application in whole or in part, in either case, without assigning any reason therefore.

In the case of Applications made by to the power of attorney by FIIs, a certified copy of the power of attorney the relevant resolution or authority, as the case may be along with the certified copy of SEBI registration certificate must be lodged with the Application Form. Failing this, the Company reserves the right to accept or reject any Application in whole or in part, in either case, without assigning any reason thereof.

In the case of Applications made by provident funds, subject to applicable law, with minimum corpus of Rs. 2500 Lacs and pension funds with minimum corpus of Rs. 2500 Lacs, a certified copy of a certificate from a chartered accountant certifying the corpus of the provident fund/pension fund must be lodged along with the Application Form. Failing this, the Company reserves the right to accept or reject any Application in whole or in part, in either case, without assigning any reason thereof.

### **Application by Provident Funds/Pension Funds**

In case of Applications made by provident funds with minimum corpus of Rs. 2,500 lakhs (subject to applicable law) and pension funds with minimum corpus of Rs. 2,500 lakhs, a certified copy of certificate from a chartered accountant certifying the corpus of the provident fund/ pension fund must be lodged along with the Application Form. Failing this, our Company reserves the right to accept or reject any Application in whole or in part, in either case, without assigning any reason thereof.

The above information is given for the benefit of the Applicants. Our Company and the LM are not liable for any amendments or modification or changes in applicable laws or regulations, which may occur after the date of filing of this Prospectus. Applicants are advised to make their independent investigations and ensure that the maximum number of Equity Shares applied for or maximum investment limits do not exceed the applicable limits under laws or regulations or as specified in this Prospectus.

### Applications by banking companies

In case of Application made by banking companies registered with RBI, certified copies of: (i) the certificate of registration issued by RBI, and (ii) the approval of such banking company's investment committee are required to be attached to the Application Form, failing which our Company and Selling Shareholder, severally and not jointly, reserve the right to reject any application without assigning any reason therefore.

The investment limit for banking companies in non-financial services companies as per the Banking Regulation Act, 1949 (the "Banking Regulation Act"), and Master Circular – Para-banking Activities dated July 1, 2015 is 10% of the paid-up share capital of the investee company or 10% of the banks' own paid-up share capital and reserves, whichever is less. Further, the investment in a non-financial services company by a banking company together with its subsidiaries, associates, joint ventures, entities directly or indirectly controlled by the bank and mutual funds managed by asset management companies controlled by the banking company cannot exceed 20% of the investee company's paid-up share capital. A banking company may hold up to 30% of the paid-up share capital of the investee company with the prior approval of the RBI provided that the investee company is engaged in non-financial activities in which banking companies are permitted to engage under the Banking Regulation Act.

### Method and Process of Application

1. The Designated Intermediaries shall accept applications from the Applicants during the Offer Period.
2. The Offer Period shall be for a minimum of three Working Days and shall not exceed 10 Working Days. The Offer Period may be extended, if required, by an additional three Working Days, subject to the total Offer Period not exceeding 10 Working Days.
3. During the Offer Period, Applicants who are interested in subscribing to the Equity Shares should approach the Designated Intermediaries to register their applications.
4. The Applicant cannot apply on another Application Form after applications on one Application Form have been submitted to the Designated Intermediaries. Submission of a second Application form to either the same or to another Designated Intermediaries will be treated as multiple applications and is liable to be rejected either before entering the application into the electronic collecting system or at any point prior to the allocation or Allotment of Equity Shares in this Offer.
5. Designated Intermediaries accepting the application forms shall be responsible for uploading the application along with other relevant details in application forms on the electronic bidding system of stock exchange and submitting the form to SCSBs for blocking of funds (except in case of SCSBs, where blocking of funds will be done by respective SCSBs only). All applications shall be stamped and thereby acknowledged by the Designated Intermediaries at the time of receipt.
6. The Designated Intermediaries will enter each application option into the electronic collecting system as a separate application and generate a TRS and give the same to the applicant.
7. Upon receipt of the Application Form, submitted whether in physical or electronic mode, the Designated Intermediaries shall verify if sufficient funds equal to the Application Amount are available in the ASBA Account, as mentioned in the Application Form, prior to uploading such applications with the Stock Exchange.
8. If sufficient funds are not available in the ASBA Account, the Designated Intermediaries shall reject such applications and shall not upload such applications with the Stock Exchange.
9. If sufficient funds are available in the ASBA Account, the SCSB shall block an amount equivalent to the Application Amount mentioned in the Application Form and will enter each application option into the electronic collecting system as a separate application and generate a TRS for each price and demand option. The TRS shall be furnished to the Applicant on request.
10. The Application Amount shall remain blocked in the aforesaid ASBA Account until finalization of the Basis of Allotment and consequent transfer of the Application Amount against the Allotted Equity Shares to the Public Offer Account, or until withdrawal/ failure of the Offer or until withdrawal/ rejection of the Application Form, as the case may be. Once the Basis of Allotment is finalized, the Registrar to the Offer shall send an appropriate request to the Controlling Branch of the SCSB for

unblocking the relevant ASBA Accounts and for transferring the amount allocable to the successful Applicants to the Public Offer Account. In case of withdrawal/ failure of the Offer, the blocked amount shall be unblocked on receipt of such information from the Registrar to the Offer.

### **Terms of payment**

The entire Offer price of ₹ 30.00 per share is payable on application. In case of allotment of lesser number of Equity Shares than the number applied, the Registrar shall instruct the SCSBs to unblock the excess amount paid on Application to the applicants.

SCSBs will transfer the amount as per the instruction of the Registrar to the Public Offer Account, the balance amount after transfer will be unblocked by the SCSBs.

The applicant should note that the arrangement with Bankers to the Offer or the Registrar is not prescribed by SEBI and has been established as an arrangement between our Company, Banker to the Offer and the Registrar to the Offer to facilitate collections from the applicants.

### **Payment mechanism**

The applicants shall specify the bank account number in their Application Form and the SCSBs shall block an amount equivalent to the Application Amount in the bank account specified in the Application Form. The SCSB shall keep the Application Amount in the relevant bank account blocked until withdrawal/ rejection of the Application or receipt of instructions from the Registrar to unblock the Application Amount. However Non Retail Applicants shall neither withdraw nor lower the size of their applications at any stage. In the event of withdrawal or rejection of the Application Form or for unsuccessful Application Forms, the Registrar to the Offer shall give instructions to the SCSBs to unblock the application money in the relevant bank account within one day of receipt of such instruction. The Application Amount shall remain blocked in the ASBA Account until finalization of the Basis of Allotment in the Offer and consequent transfer of the Application Amount to the Public Offer Account, or until withdrawal/ failure of the Offer or until rejection of the Application by the ASBA Applicant, as the case may be.

*Please note that pursuant to SEBI circular CIR/CFD/POLICYCELL/11/2015 dated November 10, 2015 investors in the public Offer can only invest through ASBA Mode.*

### **Electronic Registration of Applications**

1. The Designated Intermediaries will register the applications using the on-line facilities of the Stock Exchange.
2. The Designated Intermediaries will undertake modification of selected fields in the application details already uploaded before 1.00 p.m. of next Working Day from the Offer Closing Date.
3. The Designated Intermediaries shall be responsible for any acts, mistakes or errors or omissions and commissions in relation to,
  - (i) the applications accepted by them,
  - (ii) the applications uploaded by them
  - (iii) the applications accepted but not uploaded by them or
  - (iv) with respect to applications by Applicants, applications accepted and uploaded by any Designated Intermediary other than SCSBs, the Application form along with relevant schedules shall be sent to the SCSBs or the Designated Branch of the relevant SCSBs for blocking of funds and they will be responsible for blocking the necessary amounts in the ASBA Accounts. In case of Application accepted and Uploaded by SCSBs, the SCSBs or the Designated Branch of the relevant SCSBs will be responsible for blocking the necessary amounts in the ASBA Accounts.
4. Neither the Lead Managers nor our Company nor the Registrar to the Offer, shall be responsible for any acts, mistakes or errors or omission and commissions in relation to,
  - (i) the applications accepted by any Designated Intermediaries
  - (ii) the applications uploaded by any Designated Intermediaries or
  - (iii) the applications accepted but not uploaded by any Designated Intermediaries
5. The Stock Exchange will offer an electronic facility for registering applications for the Offer. This facility will be available at

the terminals of Designated Intermediaries and their authorized agents during the Offer Period. The Designated Branches or agents of Designated Intermediaries can also set up facilities for off-line electronic registration of applications subject to the condition that they will subsequently upload the off-line data file into the online facilities on a regular basis. On the Offer Closing Date, the Designated Intermediaries shall upload the applications till such time as may be permitted by the Stock Exchange. This information will be available with the Lead Manager on a regular basis.

6. With respect to applications by Applicants, at the time of registering such applications, the Syndicate Bakers, DPs and RTAs shall forward a Schedule as per format given below along with the Application Forms to Designated Branches of the SCSBs for blocking of funds:

S. No.	Details*
1.	Symbol
2.	Intermediary Code
3.	Location Code
4.	Application No.
5.	Category
6.	PAN
7.	DP ID
8.	Client ID
9.	Quantity
10.	Amount

*\*Stock Exchanges shall uniformly prescribe character length for each of the above-mentioned fields*

7. With respect to applications by Applicants, at the time of registering such applications, the Designated Intermediaries shall enter the following information pertaining to the Applicants into the on-line system:
- Name of the Applicant;
  - IPO Name;
  - Application Form Number;
  - Investor Category;
  - PAN (of First Applicant, if more than one Applicant);
  - DP ID of the demat account of the Applicant;
  - Client Identification Number of the demat account of the Applicant;
  - Number of Equity Shares Applied for;
  - Bank Account details;
  - Locations of the Banker to the Offer or Designated Branch, as applicable, and bank code of the SCSB branch where the ASBA Account is maintained; and
  - Bank account number.
8. In case of submission of the Application by an Applicant through the Electronic Mode, the Applicant shall complete the above-mentioned details and mention the bank account number, except the Electronic ASBA Application Form number which shall be system generated.
9. The aforesaid Designated Intermediaries shall, at the time of receipt of application, give an acknowledgment to the investor, by giving the counter foil or specifying the application number to the investor, as a proof of having accepted the application form in physical as well as electronic mode. The registration of the Application by the Designated Intermediaries does not guarantee that the Equity Shares shall be allocated / allotted either by our Company.
10. Such acknowledgment will be non-negotiable and by itself will not create any obligation of any kind.
11. In case of Non Retail Applicants and Retail Individual Applicants, applications would not be rejected except on the technical grounds as mentioned in the Prospectus. The Designated Intermediaries shall have no right to reject applications, except on technical grounds.



12. The permission given by the Stock Exchanges to use their network and software of the Online IPO system should not in any way be deemed or construed to mean that the compliance with various statutory and other requirements by our Company and/or the Lead Manager are cleared or approved by the Stock Exchanges; nor does it in any manner warrant, certify or endorse the correctness or completeness of any of the compliance with the statutory and other requirements nor does it take any responsibility for the financial or other soundness of our company; our Promoter, our management or any scheme or project of our Company; nor does it in any manner warrant, certify or endorse the correctness or completeness of any of the contents of this Prospectus, nor does it warrant that the Equity Shares will be listed or will continue to be listed on the Stock Exchanges.
13. The Designated Intermediaries will be given time till 1.00 p.m. on the next working day after the Offer Closing Date to verify the DP ID and Client ID uploaded in the online IPO system during the Offer Period, after which the Registrar to the Offer will receive this data from the Stock Exchange and will validate the electronic application details with Depository's records. In case no corresponding record is available with Depositories, which matches the three parameters, namely DP ID, Client ID and PAN, then such applications are liable to be rejected.
14. The SCSBs shall be given one day after the Offer Closing Date to send confirmation of Funds blocked (Final certificate) to the Registrar to the Offer.
15. The details uploaded in the online IPO system shall be considered as final and Allotment will be based on such details for applications.

**Allocation of Equity shares**

- 1) The Offer is being made through the Fixed Price Process wherein 3,36,000 Equity Shares shall be reserved for Market Maker. 62,40,000 Equity shares will be allocated on a proportionate basis to Retail Individual Applicants, subject to valid applications being received from Retail Individual Applicants at the Offer Price. The balance of the Net Offer will be available for allocation on proportionate basis to Non Retail Applicants.
- 2) Under- subscription if any, in any category, would be allowed to be met with spill-over from any other category or combination of categories at the discretion of our Company in consultation with the Lead Managers and the Stock Exchange.
- 3) Allocation to Non-Residents, including Eligible NRIs, Eligible QFIs, FIIs and FVCIs registered with SEBI, applying on repatriation basis will be subject to applicable law, rules, regulations, guidelines and approvals.
- 4) In terms of SEBI Regulations, Non Retail Applicants shall not be allowed to either withdraw or lower the size of their applications at any stage.
- 5) Allotment status details shall be available on the website of the Registrar to the Offer.

**Signing of Underwriting Agreement and Filing of Prospectus with ROC**

- a) Our company, Selling Shareholders, LM has entered into an Underwriting Agreement dated January 31, 2017 with underwriter.
- b) A copy of Prospectus will be filled with the RoC in terms of Section 26 of Companies Act, 2013.

**Pre-Offer Advertisement**

Subject to Section 30 of the Companies Act 2013, our Company shall, after registering the Prospectus with the RoC, publish a pre- Offer advertisement, in the form prescribed by the SEBI Regulations, in (i) English National Newspaper; (ii) Hindi National Newspaper and (iii) Regional Newspaper each with wide circulation. In the pre- Offer advertisement, we stated the Offer Opening Date and the Offer Closing Date. This advertisement, subject to the provisions of Section 30 of the Companies Act, 2013, was in the format prescribed in Part A of Schedule XIII of the SEBI Regulations.

**Issuance of Allotment Advice**

- 1) Upon approval of the Basis of Allotment by the Designated Stock Exchange.

- 2) The Lead Manager or the Registrar to the Offer will dispatch an Allotment Advice to their applicants who have been allocated Equity Shares in the Offer.

The dispatch of Allotment Advice shall be deemed a valid, binding and irrevocable contract for the Allotment to such Applicants.

### **General Instructions**

#### **Do's:**

- Check if you are eligible to apply;
- Read all the instructions carefully and complete the applicable Application Form;
- Ensure that the details about the Depository Participant and the beneficiary account are correct as Allotment of Equity Shares will be in the dematerialized form only;
- Each of the Applicants should mention their Permanent Account Number (PAN) allotted under the Income Tax Act, 1961;
- Ensure that the Demographic Details are updated, true and correct in all respects;
- Ensure that the name(s) given in the Application Form is exactly the same as the name(s) in which the beneficiary account is held with the Depository Participant.
- Ensure that you have funds equal to the Application Amount in the ASBA account maintained with the SCSB before submitting the Application Form under the ASBA process to the respective member of the Syndicate (in the Specified Locations), the SCSBs, the Registered Broker (at the Broker Centres), the RTA (at the Designated RTA Locations) or CDP (at the Designated CDP Locations); Instruct your respective Banks to release the funds blocked in the ASBA Account under the ASBA process;
- Ensure that the Application Form is signed by the account holder in case the applicant is not the account holder. Ensure that you have mentioned the correct bank account number in the Application Form;
- Ensure that the Application Forms are delivered by the applicants within the time prescribed as per the Application Form and the Prospectus;
- Ensure that you have requested for and receive a TRS;
- Ensure that you request for and receive a stamped acknowledgement of the Application Form for all your application options;
- All Investors submit their applications through the ASBA process only;
- Ensure that you receive an acknowledgement from the concerned Designated Intermediary, for the submission of your Application Form; and
- The Application Form is liable to be rejected if the above instructions, as applicable, are not complied with.

#### **Don'ts:**

- Do not apply for lower than the minimum Application size;
- Do not apply for a price different from the price mentioned herein or in the Application Form;
- Do not apply on another Application Form after you have submitted an application to the SCSBs, Registered Brokers of Stock Exchange, RTA and DPs registered with SEBI;
- Do not pay the Application Price in cash, by money order or by postal order or by stock invest;
- Do not send Application Forms by post, instead submit the Designated Intermediary only;
- Do not submit the Application Forms to any non-SCSB bank or our Company
- Do not apply on an Application Form that does not have the stamp of the relevant Designated Intermediary;
- Do not submit the application without ensuring that funds equivalent to the entire application Amount are blocked in the relevant ASBA Account;
- Do not apply for an Application Amount exceeding Rs. 2,00,000 (for applications by Retail Individual Applicants);
- Do not fill up the Application Form such that the Equity Shares applied for exceeds the Offer Size and/or investment limit or maximum number of Equity Shares that can be held under the applicable laws or regulations or maximum amount permissible under the applicable regulations;
- Do not submit the GIR number instead of the PAN as the application is liable to be rejected on this ground;
- Do not submit incorrect details of the DP ID, beneficiary account number and PAN or provide details for a beneficiary account which is suspended or for which details cannot be verified by the Registrar to the Offer;
- Do not submit applications on plain paper or incomplete or illegible Application Forms in a colour prescribed for another category of Applicant; and

- Do not make Applications if you are not competent to contract under the Indian Contract Act, 1872, as amended.
- Do not make more than five applications from one bank account.

**Instructions for Completing the Application Form**

The Applications should be submitted on the prescribed Application Form and in BLOCK LETTERS in ENGLISH only in accordance with the instructions contained herein and in the Application Form. Applications not so made are liable to be rejected. Application Forms should bear the stamp of the Designated Intermediaries. ASBA Application Forms, which do not bear the stamp of the Designated Intermediaries, will be rejected.

SEBI, vide Circular No.CIR/CFD/14/2012 dated October 04, 2012 has introduced an additional mechanism for investors to submit Application forms in public issues using the stock broker (broker) network of Stock Exchanges, who may not be syndicate members in an Offer with effect from January 01, 2013. The list of Broker Centre is available on the websites of BSE i.e. [www.bseindia.com](http://www.bseindia.com) and NSE i.e. [www.nseindia.com](http://www.nseindia.com) . With a view to broad base the reach of Investors by substantial, enhancing the points for submission of applications, SEBI vide Circular No.CIR/CFD/POLICY CELL/11/2015 dated November 10, 2015 has permitted Registrar to the Offer and Share Transfer Agent and Depository Participants registered with SEBI to accept the Application forms in Public Offer with effect front January 01, 2016. The List of ETA and DPs centres for collecting the application shall be disclosed is available on the websites of BSE i.e. [www.bseindia.com](http://www.bseindia.com) and NSE i.e. [www.nseindia.com](http://www.nseindia.com)

**Applicant's Depository Account and Bank Details**

Please note that, providing bank account details, PAN No's, Client ID and DP ID in the space provided in the application form is mandatory and applications that do not contain such details are liable to be rejected.

Applicants should note that on the basis of name of the Applicants, Depository Participant's name, Depository Participant Identification number and Beneficiary Account Number provided by them in the Application Form as entered into the Stock Exchange online system, the Registrar to the Offer will obtain front the Depository the demographic details including address, Applicants bank account details, MICR code and occupation (hereinafter referred to as 'Demographic Details'). These Demographic Details would be used for all correspondence with the Applicants including mailing of the Allotment Advice. The Demographic Details given by Applicants in the Application Form would not be used for any other purpose by the Registrar to the Offer.

By signing the Application Form, the Applicant would be deemed to have authorized the depositories to provide, upon request, to the Registrar to the Offer, the required Demographic Details as available on its records.

**Submission of Application Form**

All Application Forms duly completed shall be submitted to the Designated Intermediaries. The aforesaid intermediaries shall at the time of receipt of application, give an acknowledgement to investor, by giving the counter foil or specifying the application number to the investor, as a proof of having accepted the application form, in physical or electronic mode, respectively.

**Communications**

All future communications in connection with Applications made in this Offer should be addressed to the Registrar to the Offer quoting the full name of the sole or First Applicant, Application Form number, Applicants Depository Account Details, number of Equity Shares applied for, date of Application form, name and address of the Designated Intermediary where the Application was submitted thereof and a copy of the acknowledgement slip.

Investors can contact the Compliance Officer or the Registrar to the Offer in case of any pre Offer or post Offer related problems such as non-receipt of letters of allotment, credit of allotted shares in the respective beneficiary accounts, etc.

**Disposal of Application and Application Moneys and Interest in Case of Delay**

The Company shall ensure the dispatch of Allotment advice, and give benefit to the beneficiary account with Depository Participants and submit the documents pertaining to the Allotment to the Stock Exchange within 2 (two) working days of date of Allotment of Equity Shares.

The Company shall use best efforts to ensure that all steps 'for completion of the necessary formalities for listing and commencement of trading at SME Platform of NSE where the Equity Shares are proposed to be listed arc taken within 6 (Six) working days from Offer Closing Date.

In accordance with the Companies Act, the requirements of the Stock Exchange and the SEBI Regulations, the Company further undertakes that:

1. Allotment and Listing of Equity Shares shall be made within 6 (Six) days of the Offer Closing Date;
2. The Company will provide adequate funds required for dispatch of Allotment Advice to the Registrar to the Offer.

### **Right to Reject Applications**

In case of QIB Applicants, the Company in consultation with the LM may reject Applications provided that the reasons for rejecting the same shall be provided to such Applicant in writing. In case of Non Institutional Applicants, Retail Individual Applicants who applied, the Company has a right to reject Applications based on technical grounds.

### **Impersonation**

Attention of the investors is specifically drawn to the provisions of sub-section (1) of Section 38 of the Companies Act, 2013 which is reproduced below:

Any person who-

- a) Makes or abets making of an application in a fictitious name to a company for acquiring, or subscribing for, its securities; or
- b) Makes or abets making of multiple applications to a company in different names or in different combinations of his name or surname for acquiring or subscribing for its securities; or
- c) Otherwise induces directly or indirectly a company to allot, or register any transfer of, securities to him, or to any other person in a fictitious name,

Shall be liable to action under section 447 of the Companies, Act 2013

### **Undertakings by Our Company**

We undertakes as follows:

- 1) That the complaints received in respect of the Offer shall be attended to by us expeditiously and satisfactorily;
- 2) That all steps will be taken for the completion of the necessary formalities for listing and commencement of trading at the Stock Exchange where the Equity Shares are proposed to be listed within 6 (six) Working days of Offer Closing Date.
- 3) That if the Company do not proceed with the Offer, the reason thereof shall be given as a public notice to be issued by our Company within two days of the Offer Closing Date. The public notice shall be issued in the same newspapers where the pre-Offer advertisements were published. The stock exchange on which the Equity Shares are proposed to be listed shall also be informed promptly;
- 4) That the our Promoters' contribution in full has already been brought in;
- 5) That no further Offer of Equity Shares shall be made till the Equity Shares offered through the Prospectus are listed or until the Application monies are unblocked on account of non-listing, under subscription etc. and
- 6) That if the Company withdraws the Offer after the Offer Closing Date, our Company shall be required to file a fresh offer document with the RoC/ SEBI, in the event our Company subsequently decides to proceed with the Company;

### **Undertakings by the Selling Shareholder**

- 1) The Equity Shares offered pursuant to the Offer for Sale have been held by the Selling Shareholder for a period of at least one year prior to the date of this Prospectus, are free and clear of any liens or encumbrances and, to the extent that the Equity Shares being offered have resulted from a bonus issue, the bonus issue has been on equity shares held for a period of at least

one year prior to the filing of this Prospectus and has been issued out of free reserves and share premium existing in the financial Statement of Company;

- 2) The Selling Shareholder is the legal and beneficial owner of and has full title to the Investor Offered Shares;
- 3) The Selling Shareholder will not have recourse to the proceeds of the Offer for Sale, until approval for trading of the Equity Shares from all Stock Exchanges where listing is sought has been received;
- 4) The Selling Shareholder will not sell, transfer, dispose of in any manner or create any lien, charge or encumbrance on the Equity Shares offered in the Offer for Sale; and
- 5) The Selling Shareholder will take all such steps as may be required to ensure that the Equity Shares being sold by them in the Offer for Sale are available for transfer in the Offer for Sale.
- 6) they shall take all such steps as may be required to ensure that the Equity Shares being sold by them pursuant to the Offer are available for transfer in the Offer within the time specified under applicable law; and
- 7) they shall comply with all applicable laws, in India, including the Companies Act, the SEBI Regulations, the FEMA and the applicable circulars, guidelines and regulations issued by SEBI and RBI, each in relation to the Equity Shares offered by them in the Offer.

**Equity Shares in Dematerialized Form with NSDL or CDSL**

To enable all shareholders of our Company to have their shareholding in electronic form, the Company had signed the following tripartite agreements with the Depositories and the Registrar and Share Transfer Agent:

- a) Agreement dated January 25, 2017 between NSDL, the Company and the Registrar to the Offer;
- b) Agreement dated January 14, 2017 between CDSL, the Company and the Registrar to the Offer;

The Company's equity shares bear an ISIN No. INE506W01012

## **PART - B**

### **GENERAL INFORMATION DOCUMENT FOR INVESTING IN PUBLIC ISSUES**

This General Information Document highlights the key rules, processes and procedures applicable to public issues in accordance with the provisions of the Companies Act, 2013 (to the extent notified and in effect), the Companies Act, 1956 (without reference to the provisions thereof that have ceased to have effect upon the notification of the Companies Act, 2013), the Securities Contracts (Regulation) Act, 1956, the Securities Contracts (Regulation) Rules, 1957 and the Securities and Exchange Board of India (Issue of Capital and Disclosure Requirements) Regulations, 2009 as amended. Applicants should not construe the contents of this General Information Document as legal advice and should consult their own legal counsel and other advisors in relation to the legal matters concerning the Offer. For taking an investment decision, the Applicants should rely on their own examination of the Issuer and the Offer, and should carefully read the Draft Prospectus/ Prospectus before investing in the Offer

#### **Section 1: Purpose of the General Information Document (GID)**

This document is applicable to the public issues undertaken inter-alia through the Fixed Price Offer. The purpose of the “General Information Document for Investing in Public Issues” is to provide general guidance to potential Applicants in IPOs, on the processes and procedures governing IPOs, undertaken in accordance with the provisions of the Securities and Exchange Board of India (Issue of Capital and Disclosure Requirements) Regulations, 2009 (“**SEBI ICDR Regulations, 2009**”) as amended.

Applicants should note that investment in equity and equity related securities involves risk and Applicant should not invest any funds in the Issue unless they can afford to take the risk of losing their investment. The specific terms relating to securities and/or for subscribing to securities in an Issue and the relevant information about the Issuer undertaking the Issue; are set out in the Prospectus filed by the Issuer with the Registrar of Companies (“**RoC**”). Applicants should carefully read the entire Prospectus and the Application Form and the Abridged Prospectus of the Issuer in which they are proposing to invest through the Issue. In case of any difference in interpretation or conflict and/or overlap between the disclosure included in this document and the Prospectus, the disclosures in the Prospectus shall prevail. The Prospectus of the Issuer is available on the websites of stock exchanges, on the website(s) of the **LM(s)** to the Issue and on the website of Securities and Exchange Board of India (“**SEBI**”) at [www.sebi.gov.in](http://www.sebi.gov.in).

For the definitions of capitalized terms and abbreviations used herein Applicants may refer to the section “Glossary and Abbreviations”.

#### **Section 2: Brief Introduction to IPOs on SME Exchange**

##### **2.1 Initial public offer (IPO)**

An IPO means an offer of specified securities by an unlisted Issuer to the public for subscription and may include an Offer for Sale of specified securities to the public by any existing holder of such securities in an unlisted Issuer.

For undertaking an IPO, an Issuer is inter-alia required to comply with the eligibility requirements of in terms of either Regulation 26(1) or Regulation 26(2) of the SEBI ICDR Regulations, 2009 if applicable. For details of compliance with the eligibility requirements by the Issuer Applicants may refer to the Prospectus.

The Issuer may also undertake IPO under Chapter XB of SEBI (ICDR) regulations, wherein as per,

- Regulation 106M(1) : An issuer whose post-issue face value capital does not exceed ten crore rupees shall issue its specified securities in accordance with provisions of this Chapter.
- Regulation 106M(2) : An issuer whose post-issue face value capital is more than ten crore rupees and upto twenty five crore rupees, may also issue its specified securities in accordance with provisions of this Chapter.

The present Offer being made under Regulation 106 M (2) of Chapter XB of SEBI (ICDR) Regulation.

## 2.2 Other Eligibility Requirements

In addition to the eligibility requirements specified in paragraphs 2.1 an Issuer proposing to undertake an IPO is required to comply with various other requirements as specified in the SEBI ICDR Regulations, 2009, the Companies Act, 1956 and the Companies Act, 2013 as may be applicable (“the Companies Act”), the Securities Contracts (Regulation) Rules, 1957 (the “SCRR”), industry-specific regulations, if any, and other applicable laws for the time being in force.

Following are the eligibility requirements for making an SME IPO under Regulation 106M (2) of Chapter XB of SEBI (ICDR) Regulation:

- a) In accordance with Regulation 106(P) of SEBI (ICDR) Regulation, Issue has to be 100% underwritten and the LM has to underwrite at least 15% of the total issue size.
- b) In accordance with regulation 106(R) of SEBI (ICDR) Regulation, total number of proposed allottees in the Issue shall be greater than or equal to fifty, otherwise the entire application money will be blocked forthwith. If such money is not repaid within eight days from the date the company becomes liable to repay it, than the Company and every officer in default shall, on and from expiry of eight days, be liable to repay such application money, with interest as prescribed under Section 40 of the Companies Act, 2013.
- c) In accordance with Regulation 106(O) the SEBI (ICDR) Regulation, Company is not required to file any Offer Document with SEBI nor has SEBI issued any observations on the Offer Document. The Lead Manager shall submit the copy of Prospectus along with a Due Diligence Certificate including additional confirmations as required to SEBI at the time of filing the Prospectus with Stock Exchange and the Registrar of Companies.
- d) In accordance with Regulation 106(V) of the SEBI (ICDR) Regulation, the LM has to ensure compulsory market making for a minimum period of three years from the date of listing of Equity Shares offered in the Issue.
- e) The Issuer shall have Net Tangible Assets of at least Rs. 1 crore as per the latest audited financial result.
- f) The Net worth (excluding revaluation reserves) of the Issuer shall be at least Rs. 1 crore as per the latest audited financial result.
- g) The issuer should have a tract record of distributable profits in terms of Section 123 of Companies Act, 2013 for two out of immediately preceding three financial years.
- h) The post –issue paid up capital of the issuer shall be at least Rs. 1 crore.
- i) The issuer shall mandatorily facilitate trading in demat securities
- j) The issuer should not been referred to Board for Industrial and Financial Reconstruction.
- k) No petition for winding up is admitted by a court of competent jurisdiction against the Issuer.
- l) No material regulatory or disciplinary action should have been taken by any stock exchange or regulatory authority in the past three years against the Issuer.
- m) The company should have a website
- n) There has been no change in the promoter(s) of the company in the 1 year preceding the date of filing application to NSE for listing on SME segment.

Issuer shall also comply with all the other requirements as laid down for such an Issue under Chapter X-B of SEBI (ICDR) Regulations and subsequent circulars and guidelines issued by SEBI and the Stock Exchange.

As per Regulation 106 (M) (3) of SEBI (ICDR) Regulation, 2009 the provisions of regulations 6(1), 6(2), 6(3) , Regulation 7, Regulation 8, Regulation 9, Regulation 10, Regulation 25, Regulation 26, Regulation 27 and Sub regulation (1) of Regulation 49 of SEBI (ICDR) Regulations, 2009 shall not apply to this Offer.

Thus the Company is eligible for the Offer in accordance with Regulation 106M(2) and other provision of Chapter XB of SEBI (ICDR) Regulations as the post-Offer face value capital is more than ten crore rupees and upto twenty five crore rupees. Company also complies with the eligibility conditions laid by the SME Platform of NSE for listing of our Equity Shares.

### **2.3 Types of Public Issues – Fixed Price Issues and Book Built Issues**

In accordance with the provisions of the SEBI ICDR Regulations, 2009, an Issuer can either determine the Issue Price through the Book Building Process (“**Book Built Issue**”) or undertake a Fixed Price Issue (“**Fixed Price Issue**”). An Issuer may mention Floor Price or Price Band in the RHP (in case of a Book Built Issue) and a Price or Price Band in this Draft Prospectus (in case of a fixed price Issue) and determine the price at a later date before registering the Prospectus with the Registrar of Companies. The cap on the Price Band should be less than or equal to 120% of the Floor Price. The Issuer shall announce the Price or the Floor Price or the Price Band through advertisement in all newspapers in which the pre-issue advertisement was given at least five Working Days before the Issue Opening Date, in case of an IPO and at least one Working Day before the Issue Opening Date, in case of an FPO.

The Floor Price or the Issue price cannot be lesser than the face value of the securities.

Applicants should refer to the Prospectus or Issue advertisements to check whether the Issue is a Book Built Issue or a Fixed Price Issue.

### **2.4 Issue Period**

The Issue may be kept open for a minimum of three Working Days (for all category of Applicants) and not more than ten Working Days. Applicants are advised to refer to the Application Form and Abridged Prospectus or Prospectus for details of the Issue Period. Details of Issue Period are also available on the website of Stock Exchange.

### **2.5 Migration To Main Board**

SME Issuer may migrate to the Main Board of Stock Exchange from the SME Exchange at a later date subject to the following:

- a) If the Paid up Capital of the Company is likely to increase above Rs. 25 crores by virtue of any further issue of capital by way of rights, preferential issue, bonus issue etc. (which has been approved by a special resolution through postal ballot wherein the votes cast by the shareholders other than the Promoters in favour of the proposal amount to at least two times the number of votes cast by shareholders other than promoter shareholders against the proposal and for which the company has obtained in-principal approval from the main board), The Company shall apply to SE for listing of its shares on its Main Board subject to the fulfillment of the eligibility criteria for listing of specified securities laid down by the Main Board.

OR

- b) If the Paid up Capital of the company is more than 10 crores but below Rs. 25 crores, the Company may still apply for migration to the main board if the same has been approved by a special resolution through postal ballot wherein the votes cast by the shareholders other than the Promoters in favour of the proposal amount to at least two times the number of votes cast by shareholders other than promoter shareholders against the proposal.

### **2.6 Flowchart Of Timelines**

A flow chart of process flow in Fixed Price Issue is as follows:



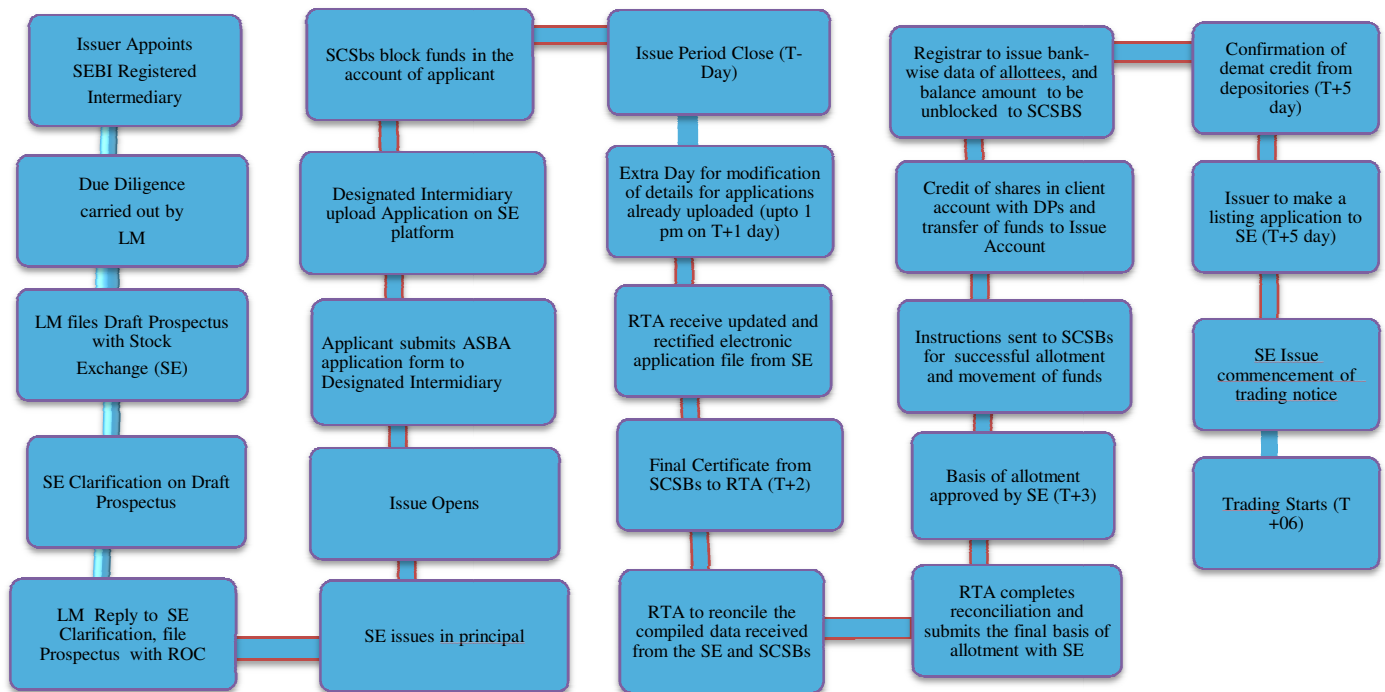

### **Section 3: Category of Investors Eligible to Participate in an Issue**

Each Applicant should check whether it is eligible to apply under applicable law. Furthermore, certain categories of Applicants, such as NRIs, FII's, FPIs and FVCIs may not be allowed to apply in the Offer or to hold Equity Shares, in excess of certain limits specified under applicable law. Applicants are requested to refer to the Prospectus for more details.

Subject to the above, an illustrative list of Applicants is as follows:

- Indian nationals resident in India who are competent to contract under the Indian Contract Act, 1872, in single or joint names (not more than three) or in the names of minors as natural / legal guardian;
- Hindu Undivided Families or HUFs, in the individual name of the Karta. The Applicant should specify that the Application is being made in the name of the HUF in the Application Form as follows: "Name of sole or first Applicant: XYZ Hindu Undivided Family applying through XYZ, where XYZ is the name of the Karta". Applications by HUFs may be considered at par with those from individuals;
- Companies, corporate bodies and societies registered under applicable law in India and authorized to invest in equity shares under their respective constitutional and charter documents;
- Mutual Funds registered with SEBI;
- Eligible NRIs on a repatriation basis or on a non-repatriation basis subject to applicable law; NRIs other than Eligible NRIs are not eligible to participate in this Offer.
- Indian Financial Institutions, scheduled commercial banks regional rural banks, co-operative banks (subject to RBI regulations and the SEBI ICDR Regulations, 2009 and other laws, as applicable);
- FPIs other than Category III foreign portfolio investors, VCFs and FVCIs registered with SEBI.
- Limited liability partnerships registered in India and authorized to invest in equity shares.
- State Industrial Development Corporations.
- Trusts/societies registered under the Societies Registration Act, 1860, as amended or under any other law relating to trusts/societies and who are authorized under their respective constitutions to hold and invest in equity shares;
- Scientific and/ or Industrial Research Organizations authorized to invest in equity shares.
- Insurance Companies registered with IRDA;

- Provident Funds and Pension Funds with minimum corpus of Rs. 2500 Lakhs and who are authorized under their constitution to hold and invest in equity shares;
- Multilateral and Bilateral Development Financial Institutions;
- National Investment Fund set up by resolution no F.No.2/3/2005-DDII dated November 23, 2005 of Government of India published in the Gazette of India;
- Insurance funds set up and managed by army, navy, air force of the Union of India or by Department of Posts, India;
- Any other person eligible to apply to this Offer, under the laws, rules, regulations, guidelines, and policies applicable to them and under Indian Laws.

**Applications not to be made by:**

- Minors (except under guardianship)
- Partnership firms or their nominees
- Foreign Nationals (except NRIs)
- Overseas Corporate Bodies

**Section 4: Applying in the Issue**

**Fixed Price Issue:** Applicants should only use the specified cum Application Form either bearing the stamp of Designated Intermediaries as available or downloaded from the websites of the Stock Exchanges. Application Forms are available with the registered office of the Issuer, and office of the RTA and at the office of the LM. For further details regarding availability of Application Forms, Applicants may refer to the Prospectus.

Applicants should ensure that they apply in the appropriate category. The prescribed color of the Application Form for various categories of Applicants is as follows:

Category	Color of the Application
Resident Indian, Eligible NRIs applying on a non -repatriation basis	White
NRIs, FVCIs, FIIs, their Sub-Accounts (other than Sub-Accounts which are foreign corporate(s) or foreign individuals applying under the QIB), FPIs on a repatriation basis	Blue

Securities Issued in an IPO can only be in dematerialized form in compliance with Section 29 of the Companies Act, 2013. Applicants will not have the option of getting the allotment of specified securities in physical form. However, they may get the specified securities rematerialized subsequent to allotment.

**4.1 Instructions For Filing Application Form (Fixed Price Issue)**

Applicants may note that forms not filled completely or correctly as per instructions provided in this GID, the Prospectus and Application Form are liable to be rejected.

Instructions to fill each field of the Application Form can be found on the reverse side of the Application Form. Specific instructions for filling various fields of the Resident Application Form and Non-Resident Application Form and samples are provided below.

The samples of the Application Form for resident Applicants and the Application Form for non-resident Applicants are reproduced below:



Application form for Residents

PLEASE FILL IN BLOCK LETTERS

<b>COMMON BID CUM APPLICATION FORM</b>	<b>XYZ LIMITED - INITIAL PUBLIC ISSUE - R</b> Address : _____ Contact Details: _____ CIN No _____	<b>FOR RESIDENT INDIANS, INCLUDING RESIDENT QIBs AND ELIGIBLE NRIs APPLYING ON A NON-REPATRIATION BASIS</b>
LOGO	TO, THE BOARD OF DIRECTORS XYZ LIMITED	<b>FIXED PRICE GME ISSUE</b> <b>INE000000000</b>
		<b>Bid cum Application Form No.</b> _____
<b>SYNDICATE MEMBER'S STAMP &amp; CODE</b>	<b>BROKER/SCSB/DP/RTA STAMP &amp; CODE</b>	<b>1. NAME &amp; CONTACT DETAILS OF SOLE / FIRST BIDDER</b>
		Mr. / Ms. _____
<b>SUB-BROKER 3 / SUB-AGENT 3 STAMP &amp; CODE</b>	<b>ESCROW BANK/SCSB BRANCH STAMP &amp; CODE</b>	Address _____
		Email _____
<b>BANK BRANCH SERIAL NO.</b>	<b>SCSB SERIAL NO.</b>	Tel. No (with STD code) / Mobile _____
		<b>2. PAN OF SOLE / FIRST BIDDER</b>
		_____
<b>3. BIDDER'S DEPOSITORY ACCOUNT DETAILS</b> <input type="checkbox"/> NSDL <input type="checkbox"/> CDSL		<b>6. INVESTOR STATUS</b>
For NSDL, enter 8 digit DP ID followed by 8 digit Client ID / For CDSL, enter 16 digit Client ID		<input type="checkbox"/> Individual(s) - IND
		<input type="checkbox"/> Hindu Undivided Family* - HUF
		<input type="checkbox"/> Bodies Corporate - CO
		<input type="checkbox"/> Banks & Financial Institutions - FI
		<input type="checkbox"/> Mutual Funds - MF
		<input type="checkbox"/> Non-Resident Indians - NRI (Non-Repatriation basis)
		<input type="checkbox"/> National Investment Fund - NIF
		<input type="checkbox"/> Insurance Funds - IF
		<input type="checkbox"/> Insurance Companies - IC
		<input type="checkbox"/> Venture Capital Funds - VCF
		<input type="checkbox"/> Alternative Investment Funds - AIF
		<input type="checkbox"/> Others (Please specify) - OTH
		* HUF should apply only through Karo Application by HUF would be treated as per each Individual
<b>4. BID OPTIONS (ONLY RETAIL INDIVIDUAL BIDDERS CAN BID AT "CUT-OFF")</b>		<b>5. CATEGORY</b>
<b>Bid Options</b>	<b>No. of Equity Shares Bid (In Figures) (Bid must be in multiples of Bid Lot as advertised)</b>	<input type="checkbox"/> Retail Investor Bidder
	<b>Price per Equity Share (₹) "Cut-off" (Price in multiples of ₹ 1/- only) (In Figures)</b>	<input type="checkbox"/> Non-Institutional Bidder
	<b>Bid Price</b>	<input type="checkbox"/> QIB
	<b>Retail Discount</b>	
	<b>Net Price</b>	
	<b>Cut-off (Please tick)</b>	
Option 1		
(OR) Option 2		
(OR) Option 3		
<b>7. PAYMENT DETAILS</b>		<b>PAYMENT OPTION : FULL PAYMENT</b> <input type="checkbox"/> <b>PART PAYMENT</b> <input type="checkbox"/>
Amount paid (₹ in figures) _____ (₹ in words) _____		
ASBA Bank A/c No. _____		
Bank Name & Branch _____		
<small>IN FULL PAYMENT OF JOINT APPLICANTS, IF ANY, HEREBY CONFIRM THAT I/WE HAVE READ AND UNDERSTOOD THE TERMS AND CONDITIONS OF THIS BID CUM APPLICATION FORM AND THE ATTACHED ABSTRACT PROSPECTUS AND THE GENERAL INFORMATION DOCUMENT FOR INVESTING IN PUBLIC ISSUES ("GID") AND HEREBY AGREE AND CONFIRM THE "BIDDERS UNDERTAKING" AS GIVEN OVERLEAF. I/WE (ON BEHALF OF JOINT APPLICANTS, IF ANY) HEREBY CONFIRM THAT I/WE HAVE READ THE INSTRUCTIONS FOR FILLING UP THE BID CUM APPLICATION FORM GIVEN OVERLEAF.</small>		
<b>8A. SIGNATURE OF SOLE / FIRST BIDDER</b>	<b>8B. SIGNATURE OF ASBA BANK ACCOUNT HOLDER(S) (AS PER BANK RECORDS)</b>	<b>BROKER/SCSB/DP/RTA STAMP</b> (Acknowledgement slip of Bid in Stock Exchange system)
Date : _____	1) _____ 2) _____ 3) _____	
TEAR HERE		
LOGO	<b>XYZ LIMITED</b> <b>INITIAL PUBLIC ISSUE - R</b>	<b>Acknowledgement Slip for Broker/SCSB/DP/RTA</b>
		<b>Bid cum Application Form No.</b> _____
<b>DPID / CLID</b>		<b>PAN of Sole / First Bidder</b>
		_____
Amount paid (₹ in figures) _____	Bank & Branch _____	<b>Stamp &amp; Signature of SCSB Branch</b>
ASBA Bank A/c No. _____		
Received from Mr./Ms. _____		
Telephone / Mobile _____	Email _____	
TEAR HERE		
<b>XYZ LIMITED - INITIAL PUBLIC ISSUE - R</b>	<b>Option 1</b> <b>Option 2</b> <b>Option 3</b>	<b>Name of Sole / First Bidder</b>
No. of Equity Shares		_____
Bid Price		
Amount Paid (₹)		
ASBA Bank A/c No. _____	<b>Stamp &amp; Signature of Broker / SCSB / DP / RTA</b>	
Bank & Branch _____		
		<b>Acknowledgement Slip for Bidder</b>
		<b>Bid cum Application Form No.</b> _____

TEAR HERE

Application Form for Non-Residents

<p style="writing-mode: vertical-rl; transform: rotate(180deg);">TEAR HERE</p>	<b>COMMON BID CUM APPLICATION FORM</b>	<b>XYZ LIMITED - INITIAL PUBLIC ISSUE - NR</b> Address : ..... Contact Details: ..... CIN No .....	For Eligible NRI, FI, FVCI, applying on Restriction Basis																															
<p style="writing-mode: vertical-rl; transform: rotate(180deg);">PLEASE FILL IN BLOCK LETTERS</p>	LOGO TO, THE BOARD OF DIRECTORS XYZ LIMITED	FIXED PRICE GME ISSUE INE000000000	Bid cum Application Form No.																															
<p style="writing-mode: vertical-rl; transform: rotate(180deg);">TEAR HERE</p>	SYNDICATE MEMBER'S STAMP & CODE BROKER/SCSB/DP/RTA STAMP & CODE SUB-BROKER'S / SUB-AGENT'S STAMP & CODE ESCROW BANK/CSB BRANCH STAMP & CODE BANK BRANCH SERIAL NO. SCSB SERIAL NO.	<b>1. NAME &amp; CONTACT DETAILS OF SOLE / FIRST BIDDER</b> Mr. / Ms. _____ Address _____ Email _____ Tel. No (with STD code) / Mobile _____ <b>2. PAN OF SOLE / FIRST BIDDER</b> _____																																
<p style="writing-mode: vertical-rl; transform: rotate(180deg);">TEAR HERE</p>	<b>3. BIDDER'S DEPOSITORY ACCOUNT DETAILS</b> <input type="checkbox"/> NSDL <input type="checkbox"/> CDSL For NSDL, enter 8 digit DP ID followed by 8 digit Client ID / For CDSL, enter 16 digit Client ID		<b>6. Investor Status</b> <input type="checkbox"/> Non-Resident Indian (Residential Basis)    NRI <input type="checkbox"/> Foreign Institutional Investor    FI <input type="checkbox"/> Foreign Venture Capital Investor    FVCI <input type="checkbox"/> FI Sub Account Corporate/ Individual    FI SA <input type="checkbox"/> Others (Please Specify)    OTH																															
<p style="writing-mode: vertical-rl; transform: rotate(180deg);">TEAR HERE</p>	<b>4. BID OPTIONS (ONLY RETAIL INDIVIDUAL BIDDERS CAN BID AT "CUT-OFF")</b>																																	
<table border="1" style="width:100%; border-collapse: collapse;"> <thead> <tr> <th rowspan="2">Bid Option</th> <th rowspan="2">No. of Equity Shares Bid (In Figures) (Bids must be in multiples of Bid Lot as advertised)</th> <th colspan="3">Price per Equity Share (₹) "Cut-off" (Price in multiples of ₹ 1/- only) (In Figures)</th> <th rowspan="2">"Cut-off" (Please tick)</th> <th rowspan="2">5. CATEGORY</th> </tr> <tr> <th>Bid Price</th> <th>Retail Discount</th> <th>Net Price</th> </tr> </thead> <tbody> <tr> <td>Option 1</td> <td></td> <td></td> <td></td> <td></td> <td><input type="checkbox"/></td> <td><input type="checkbox"/> Retail Individual Bidder</td> </tr> <tr> <td>(OR) Option 2</td> <td></td> <td></td> <td></td> <td></td> <td><input type="checkbox"/></td> <td><input type="checkbox"/> Non-Institutional Bidder</td> </tr> <tr> <td>(OR) Option 3</td> <td></td> <td></td> <td></td> <td></td> <td><input type="checkbox"/></td> <td><input type="checkbox"/> QIB</td> </tr> </tbody> </table>	Bid Option	No. of Equity Shares Bid (In Figures) (Bids must be in multiples of Bid Lot as advertised)	Price per Equity Share (₹) "Cut-off" (Price in multiples of ₹ 1/- only) (In Figures)			"Cut-off" (Please tick)	5. CATEGORY	Bid Price	Retail Discount	Net Price	Option 1					<input type="checkbox"/>	<input type="checkbox"/> Retail Individual Bidder	(OR) Option 2					<input type="checkbox"/>	<input type="checkbox"/> Non-Institutional Bidder	(OR) Option 3					<input type="checkbox"/>	<input type="checkbox"/> QIB	<b>7. PAYMENT DETAILS</b> <b>PAYMENT OPTION : FULL PAY</b> Amount paid (₹ in figures) _____ (₹ in words) _____ ASBA Bank A/c No. _____ Bank Name & Branch _____		
Bid Option			No. of Equity Shares Bid (In Figures) (Bids must be in multiples of Bid Lot as advertised)	Price per Equity Share (₹) "Cut-off" (Price in multiples of ₹ 1/- only) (In Figures)				"Cut-off" (Please tick)	5. CATEGORY																									
	Bid Price	Retail Discount		Net Price																														
Option 1					<input type="checkbox"/>	<input type="checkbox"/> Retail Individual Bidder																												
(OR) Option 2					<input type="checkbox"/>	<input type="checkbox"/> Non-Institutional Bidder																												
(OR) Option 3					<input type="checkbox"/>	<input type="checkbox"/> QIB																												
<p style="writing-mode: vertical-rl; transform: rotate(180deg);">TEAR HERE</p>	I/WE (ON BEHALF OF JOINT APPLICANTS, IF ANY) HEREBY CONFIRM THAT I/WE HAVE READ AND UNDERSTOOD THE TERMS AND CONDITIONS OF THIS BID CUM APPLICATION FORM AND THE ATTACHED AGREED PROSPECTUS AND THE GENERAL INFORMATION DOCUMENT FOR INVESTING IN PUBLIC ISSUES ("GID") AND HEREBY AGREE AND CONFIRM THE "BIDDERS UNDERTAKING" AS GIVEN OVERLEAF. I/WE (ON BEHALF OF JOINT APPLICANTS, IF ANY) HEREBY CONFIRM THAT I/WE HAVE READ THE INSTRUCTIONS FOR FILING UP THE BID CUM APPLICATION FORM GIVEN OVERLEAF.																																	
<p style="writing-mode: vertical-rl; transform: rotate(180deg);">TEAR HERE</p>	<b>8A. SIGNATURE OF SOLE/ FIRST BIDDER</b> _____ Date : _____	<b>8B. SIGNATURE OF ASBA BANK ACCOUNT HOLDER(S) (AS PER BANK RECORDS)</b> I/We authorize the SCSE to do all acts as are necessary to make the Application in the law 1) _____ 2) _____ 3) _____	<b>BROKER / SCSE / DP / RTA STAMP (Acknowledging upload of Bid in Stock Exchange system)</b> _____																															
<p style="writing-mode: vertical-rl; transform: rotate(180deg);">TEAR HERE</p>	LOGO <b>XYZ LIMITED</b> <b>INITIAL PUBLIC ISSUE - NR</b>	<b>Acknowledgement Slip for Broker/SCSB/DP/RTA</b>	Bid cum Application Form No. _____ PAN of Sole / First Bidder _____																															
<p style="writing-mode: vertical-rl; transform: rotate(180deg);">TEAR HERE</p>	DP/ID / CL/ID _____ Amount paid (₹ in figures) _____ Bank & Branch _____ ASBA Bank A/c No. _____ Received from Mr./Ms. _____ Telephone / Mobile _____ Email _____	Stamp & Signature of SCSE Branch _____																																
<p style="writing-mode: vertical-rl; transform: rotate(180deg);">TEAR HERE</p>	<b>XYZ LIMITED - INITIAL PUBLIC ISSUE - NR</b> <table border="1" style="width:100%; border-collapse: collapse;"> <thead> <tr> <th></th> <th>Option 1</th> <th>Option 2</th> <th>Option 3</th> </tr> </thead> <tbody> <tr> <td>No. of Equity Shares</td> <td></td> <td></td> <td></td> </tr> <tr> <td>Bid Price</td> <td></td> <td></td> <td></td> </tr> <tr> <td>Amount Paid (₹)</td> <td></td> <td></td> <td></td> </tr> </tbody> </table> ASBA Bank A/c No. _____ Bank & Branch _____		Option 1	Option 2	Option 3	No. of Equity Shares				Bid Price				Amount Paid (₹)				Stamp & Signature of Broker / SCSE / DP / RTA _____ Name of Sole / First Bidder _____	<b>Acknowledgement Slip for Bidder</b> Bid cum Application Form No. _____															
	Option 1	Option 2	Option 3																															
No. of Equity Shares																																		
Bid Price																																		
Amount Paid (₹)																																		

#### 4.1.1 FIELD NUMBER 1: NAME AND CONTACT DETAILS OF THE SOLE/FIRST APPLICANT

Applicants should ensure that the name provided in this field is exactly the same as the name in which the Depository Account is held.

- a) **Mandatory Fields:** Applicants should note that the name and address fields are compulsory and e-mail and/or telephone number/mobile number fields are optional. Applicants should note that the contact details mentioned in the Application Form may be used to dispatch communications(including letters notifying the unblocking of the bank accounts of Applicants) in case the communication sent to the address available with the Depositories are returned undelivered or are not available. The contact details provided in the Application Form may be used by the Issuer,
- b) The Designated Intermediaries and the Registrar to the Issue only for correspondence(s) related to an Issue and for no other purposes.
- c) **Joint Applications:** In the case of Joint Applications, the Applications should be made in the name of the Applicant whose name appears first in the Depository account. The name so entered should be the same as it appears in the Depository records. The signature of only such first Applicant would be required in the Application Form and such first Applicant would be deemed to have signed on behalf of the joint holders All communications may be addressed to such Applicant and may be dispatched to his or her address as per the Demographic Details received from the Depositories.
- d) **Impersonation:** Attention of the Applicants is specifically drawn to the provisions of sub-section (1) of Section 38 of the Companies Act, 2013 which is reproduced below:

**“Any person who:**

- makes or abets making of an application in a fictitious name to a company for acquiring, or subscribing for, its securities; or
  - makes or abets making of multiple applications to a company in different names or in different combinations of his name or surname for acquiring or subscribing for its securities; or
  - otherwise induces directly or indirectly a company to allot, or register any transfer of, securities to him, or to any other person in a fictitious name, shall be liable for action under Section 447.”
- e) **Nomination Facility to Applicant:** Nomination facility is available in accordance with the provisions of Section 72 of the Companies Act, 2013. In case of allotment of the Equity Shares in dematerialized form, there is no need to make a separate nomination as the nomination registered with the Depository may prevail. For changing nominations, the Applicants should inform their respective DP.

#### 4.1.2 FIELD NUMBER 2: PAN NUMBER OF SOLE FIRST APPLICANT

- a) PAN (of the sole/ first Applicant) provided in the Application Form should be exactly the same as the PAN of the person(s) in whose name the relevant beneficiary account is held as per the Depositories’ records.
- b) PAN is the sole identification number for participants transacting in the securities market irrespective of the amount of transaction except for Applications on behalf of the Central or State Government, Applications by officials appointed by the courts and Applications by Applicants residing in Sikkim (“PAN Exempted Applicants”). Consequently, all Applicants, other than the PAN Exempted Applicants, are required to disclose their PAN in the Application Form, irrespective of the Application Amount. A Application Form without PAN, except in case of Exempted Applicants, is liable to be rejected. Applications by the Applicants whose PAN is not available as per the Demographic Details available in their Depository records, are liable to be rejected.
- c) The exemption for the PAN Exempted Applicants is subject to (a) the Demographic Details received from the respective Depositories confirming the exemption granted to the beneficiary owner by a suitable description in the PAN field and the beneficiary account remaining in “active status”; and (b) in the case of residents of Sikkim, the address as per the Demographic Details evidencing the same.
- d) Application Forms which provide the General Index Register Number instead of PAN may be rejected.

- e) Applications by Applicants whose demat accounts have been ‘suspended for credit’ are liable to be rejected pursuant to the circular issued by SEBI on July 29, 2010, bearing number CIR/MRD/DP/22/2010. Such accounts are classified as “Inactive demat accounts” and demographic details are not provided by depositories.

#### 4.1.3 FIELD NUMBER 3: APPLICANTS DEPOSITORY ACCOUNT DETAILS

- a) Applicants should ensure that DP ID and the Client ID are correctly filled in the Application Form. The DP ID and Client ID provided in the Application Form should match with the DP ID and Client ID available in the Depository database, **otherwise, the Application Form is liable to be rejected.**
- b) Applicants should ensure that the beneficiary account provided in the Application Form is active.
- c) Applicants should note that on the basis of DP ID and Client ID as provided in the Application Form, the Applicant may be deemed to have authorized the Depositories to provide to the Registrar to the Issue, any requested Demographic Details of the Applicant as available on the records of the depositories. These Demographic Details may be used, among other things, for unblocking of ASBA Account or for other correspondence(s) related to an Issue.
- d) Applicants are, advised to update any changes to their Demographic Details as available in the records of the Depository Participant to ensure accuracy of records. Any delay resulting from failure to update the Demographic Details would be at the Applicants’ sole risk.

#### 4.1.4 FIELD NUMBER 4: APPLICATION DETAILS

- a) The Issuer may mention Price in the Prospectus. However a Prospectus registered with RoC contains one price.
- b) Minimum and Maximum Application Size

- i. For Retails Individual Applicants

The Application must be for a minimum of 4000 equity shares. As the application price payable by the retail individual applicants cannot exceed Rs. 200000 they can make Application for only minimum Application size i.e for 4000 equity shares.

- ii. For Other Applicants (Non Institutional Applicants and QIBs):

The Application must be for a minimum of such number of equity shares such that the Application Amount exceeds Rs. 200000 and in multiples of 4000 equity shares thereafter. An application cannot be submitted for more than the Issue Size. However, the maximum application by a QIB investor should not exceed the investment limits prescribed for them by applicable laws. Under existing SEBI Regulations, a QIB Applicant cannot withdraw its Application after the Offer Closing Date and is required to pay 100% QIB Margin upon submission of Application. In case of revision of Applications, the Non Institutional Applicants, who are individuals, have to ensure that the Application Amount is greater than Rs. 200000 for being considered for allocation in the Non Institutional Portion. Applicants are advised to ensure that any single Application from them does not exceed the investment limits or maximum number of equity shares that can be held by them under prescribed law or regulation or as specified in this Prospectus.

- c) **Multiple Applications:** An applicant should submit only one Application Form. Submission of a second Application Form to either the same or to the Designated Intermediaries and duplicate copies of Application Forms bearing the same application number shall be treated as multiple applications and are liable to be rejected.
- d) Applicants are requested to note the following procedures may be followed by the Registrar to the issue to detect multiple applications:
- i. All applications may be checked for common PAN as per the records of the Depository. For Applicants other than Mutual Funds and PFI sub-accounts, applications bearing the same PAN may be treated as multiple applications by an Applicant and may be rejected.

- ii. For applications from Mutual Funds and FPI sub-accounts, submitted under the same PAN, as well as Applications on behalf of the PAN Exempted Applicants, the Application Forms may be checked for common DP ID and Client ID. In any such applications which have the same DP ID and Client ID, these may be treated as multiple applications and may be rejected.
- e) The following applications may not be treated as multiple applications:
  - i. Application by Reserved Categories in their respective reservation portion as well as that made by them in the Net Offer portion in public category.
  - ii. Separate applications by Mutual Funds in respect of more than one scheme of the Mutual Fund provided that the Application clearly indicates the scheme for which the application has been made.
  - iii. Application by Mutual Funds, and sub-accounts of FPIs (or FPIs and its sub-accounts) submitted with the same PAN but with different beneficiary account numbers, Client IDs, and DP IDs.

#### **4.1.5 FIELD NUMBER 5: CATEGORY OF APPLICANTS**

- a) The categories of Applicants identified as per the SEBI ICDR Regulations, 2009 for the purpose of Application, allocation and allotment in the Issue are RIIs, Individual applicants other than RIIs, and other investors (including corporate bodies or institutions, irrespective of the number of specified securities applied for).
- b) An Issuer can make reservation for certain categories of Applicants as permitted under the SEBI ICDR Regulations, 2009. For details of any reservations made in the Issue, Applicants may refer to the Prospectus.
- c) The SEBI ICDR Regulations, 2009, specify the allocation or allotment that may be made to various categories of Applicants in an Issue depending upon compliance with the eligibility conditions. For details pertaining to allocation and Issue specific details in relation to allocation Applicant may refer to the Prospectus.

#### **4.1.6 FIELD NUMBER 6: INVESTOR STATUS**

- a) Each Applicant should check whether it is eligible to apply under applicable law and ensure that any prospective allotment to it in the Issue is in compliance with the investment restrictions under applicable law.
- b) Certain categories of Applicants, such as NRIs, FIIs, FPIs and FVCIs may not be allowed to Apply in the Issue or hold Equity Shares exceeding certain limits specified under applicable law. Applicants are requested to refer to the Prospectus for more details.
- c) Applicants should check whether they are eligible to apply on non-repatriation basis or repatriation basis and should accordingly provide the investor status. Details regarding investor status are different in the Resident Application Form and Non-Resident Application Form.
- d) Applicants should ensure that their investor status is updated in the Depository records.

#### **4.1.7 FIELD NUMBER 7: PAYMENT DETAILS**

- a) All Applicants are required to use ASBA facility to block the full Amount (net of any Discount, as applicable) along-with the Application Form. If the Discount is applicable in the Issue, the RIIs should indicate the full Amount in the Application Form and the funds shall be blocked for Amount net of Discount. Only in cases where the Prospectus indicates that part payment may be made, such an option can be exercised by the Applicant.
- b) All categories of investors can participate in the Offer only through ASBA mechanism.
- c) Application Amount cannot be paid in cash, through money order or through postal order or through stock invest.

##### **4.1.7.1 Payment instructions for Applicants**

- (a) Applicants may submit the Application Form either in physical mode or online mode to any Designated Intermediaries.

- (b) Applicants should specify the Bank Account number in the Application Form. The Application Form submitted by an Applicant and which is accompanied by cash, demand, money order, postal order or any mode of payment other than blocked amounts in the ASBA Account maintained with an SCSB, may not be accepted.
- (c) Applicant should ensure that the Application Form is also signed by the ASBA Account holder(s) if the Applicant is not the ASBA Account holder;
- (d) Applicant shall note that for the purpose of blocking funds under ASBA facility clearly demarcated funds shall be available in the account.
- (e) From one ASBA Account, a maximum of five Application Forms can be submitted.
- (f) Applicants applying through a member of the Syndicate should ensure that the Application Form is submitted to a member of the Syndicate only at the Specified Locations. Applicants should also note that Application Forms submitted to the Syndicate at the Specified Locations may not be accepted by the member of the Syndicate if the SCSB where the ASBA Account, as specified in the Application Form, is maintained has not named at least one branch at that location for the members of the Syndicate to deposit Application Forms (a list of such branches is available on the website of SEBI at <http://www.sebi.gov.in/sebiweb/home/list/5/33/0/0/Recognised-Intermediaries>).
- (g) Applicants applying through a Registered Broker, RTA or CDP should note that Application Forms submitted to them may not be accepted, if the SCSB where the ASBA Account, as specified in Application Form, is maintained has not named at least one branch at that location for the Registered Brokers, RTA or CDP, as the case may be, to deposit Application Forms.
- (h) ASBA Applicant applying directly through the SCSBs should ensure that the Application Form is submitted to a Designated Branch of a SCSB where the ASBA Account is maintained.
- (i) Upon receipt of Application Form, the Designated Branch of the SCSB may verify if sufficient funds equal to the Application Amount are available in the ASBA Account, as mentioned in the Application Form.
- (j) If sufficient funds are available in the ASBA Account, the SCSB may block an amount equivalent to the Application Amount mentioned in the Application Form may upload the details on the Stock Exchange Platform.
- (k) If sufficient funds are not available in the ASBA Account, the Designated Branch of the SCSB may not upload such Applications on the Stock Exchange platform and such Applications are liable to be rejected.
- (l) Upon submission of a completed Application Form each Applicant may be deemed to have agreed to block the entire Application Amount and authorized the Designated Branch of the SCSB to block the Application Amount specified in the Application Form in the ASBA Account maintained with the SCSBs.
- (m) The Application Amount may remain blocked in the aforesaid ASBA Account until finalisation of the Basis of allotment and consequent transfer of the Application Amount against the Allotted Equity Shares to the Public Issue Account, or until withdrawal or failure of the Offer, or until withdrawal or rejection of the Application, as the case may be.
- (n) SCSBs applying in the Offer must apply through an Account maintained with any other SCSB; else their Application is liable to be rejected.

#### 4.1.8 Unblocking of ASBA Account

- a) Once the Basis of Allotment is approved by the Designated Stock Exchange, the Registrar to the Issue may provide the following details to the controlling branches of each SCSB, along with instructions to unblock the relevant bank accounts and for successful applications transfer the requisite money to the Public Issue Account designated for this purpose, within the specified timelines: (i) the number of Equity Shares to be Allotted, if any, against each Application, (ii) the amount to be transferred from the relevant bank account to the Public Issue Account, for each Application, (iii) the date by which funds referred to in (ii) above may be transferred to the Public Issue Account, and (iv) details of rejected/ non allotment / partial allotment ASBA Application, if any, along with reasons for rejection and details of withdrawn or unsuccessful Application, if any, to enable the SCSBs to unblock the respective bank accounts.



- b) On the basis of instructions from the Registrar to the Issue, the SCSBs may transfer the requisite amount against each successful Application to the Public Issue Account and may unblock the excess amount, if any, in the ASBA Account.

In the event of withdrawal or rejection of the Application Form and for unsuccessful Application, the Registrar to the Issue may give instructions to the SCSB to unblock the Application Amount in the relevant ASBA Account within 6 Working Days of the Offer Closing Date.

#### 4.1.8.1 Discount (if applicable)

- a) The Discount is stated in absolute rupee terms.
- b) RII, Employees and Retail Individual Shareholders are only eligible for discount. For Discounts offered in the Offer, Applicants may refer to the Prospectus.
- c) For the Applicants entitled to the applicable Discount in the Offer the Application Amount less Discount (if applicable) shall be blocked.

#### 4.1.8.2 Additional Instructions for NRIs

The Non-Resident Indians who intend to block funds in their Non-Resident Ordinary (NRO) accounts shall use the form meant for Resident Indians (non-repatriation basis). In the case of Application by NRIs applying on a repatriation basis, blocking of funds in their NRO account shall not be accepted.

### 4.1.9 FIELD NUMBER 8: SIGNATURES AND OTHER AUTHORISATIONS

- a) Only the First Applicant is required to sign the Application Form. Applicants should ensure that signatures are in one of the languages specified in the Eighth Schedule to the Constitution of India.
- b) If the ASBA Account is held by a person or persons other than the Applicant, then the Signature of the ASBA Account holder(s) is also required.
- c) In relation to the Applications, signature has to be correctly affixed in the authorization/undertaking box in the Application Form, or an authorization has to be provided to the SCSB via the electronic mode, for blocking funds in the ASBA Account equivalent to the Application Amount mentioned in the Application Form.
- d) Applicants must note that Application Form without signature of Applicant and /or ASBA Account holder is liable to be rejected.

### 4.1.10 ACKNOWLEDGEMENT AND FUTURE COMMUNICATION

Applicants should ensure that they receive the acknowledgment duly signed and stamped by the Designated Intermediary, as applicable, for submission of the Application Form.

- a) All communications in connection with Applications made in the Offer should be addressed as under:
  - i. In case of queries related to Allotment, non-receipt of Allotment Advice, credit of allotted equity shares, unblocking of funds, the Applicants should contact the Registrar to the Issue.
  - ii. In case of Applications submitted to the Designated Branches of the SCSBs or Registered Brokers or Registered RTA/DP, the Applicants should contact the relevant Designated Branch of the SCSB or Registered Brokers or Registered RTA/DP, as the case maybe.
  - iii. Applicant may contact the Company Secretary and Compliance Officer or LM(s) in case of any other complaints in relation to the Offer.
- b) The following details (as applicable) should be quoted while making any queries –
  - i. Full name of the sole or Applicant, Application Form number, Applicants' DP ID, Client ID, PAN, number of Equity Shares applied for, amount paid on application.
  - ii. name and address of the Designated Intermediary, where the Application was submitted; or

- iii. In case of ASBA Applications, ASBA Account number in which the amount equivalent to the Application Amount was blocked.

For further details, Applicant may refer to the Prospectus and the Application Form.

#### **4.2 INSTRUCTIONS FOR FILING THE REVISIONFORM**

- a) During the Offer Period, any Applicant (other than QIBs and NIIs, who can only revise their application upwards) who has registered his or her interest in the Equity Shares at a particular number of shares is free to revise number of shares applied using revision forms available separately.
- b) RII may revise their applications till closure of the Offer period or withdraw their applications until finalization of allotment.
- c) Revisions can be made in both the desired number of Equity Shares and the application Amount by using the Revision Form.
- d) The Applicant can make this revision any number of times during the Offer Period. However, for any revision(s) in the Application, the Applicants will have to use the services of the same Designated Intermediary through which such Applicant had placed the original Application.

A sample Revision form is reproduced below:



<b>COMMON BID REVISION FORM</b>	<b>XYZ LIMITED - INITIAL PUBLIC ISSUE - R</b> Address : _____ Contact Details: _____ CIN No. _____	<b>FOR RESIDENT INDIANS, INCLUDING RESIDENT QIBs, AND ELIGIBLE NRIs APPLYING ON A NON-REPATRIATION BASIS</b>				
LOGO: <b>TO, THE BOARD OF DIRECTORS XYZ LIMITED</b>	<b>BOOK BUILT ISSUE</b> ISIN : _____	Bid cum Application Form No. _____				
<b>SYNDICATE MEMBER'S STAMP &amp; CODE</b>	<b>BROKER/SCSB/DP/RTA STAMP &amp; CODE</b>	<b>1. NAME &amp; CONTACT DETAILS OF SOLE / FIRST BIDDER</b>				
<b>SUB-BROKER'S / SUB-AGENT'S STAMP &amp; CODE</b>	<b>ERISROW BANK/SCSB BRANCH STAMP &amp; CODE</b>	Mr./Ms. _____ Address: _____ Tel. No (with STD code) / Mobile: _____ Email: _____				
<b>BANK BRANCH SERIAL NO.</b>	<b>SCSB SERIAL NO.</b>	<b>2. PAN OF SOLE / FIRST BIDDER</b> _____				
		<b>3. BIDDER'S DEPOSITORY ACCOUNT DETAILS</b> <input type="checkbox"/> NSDL <input type="checkbox"/> CDSL For NSDL, enter 8 digit DP ID followed by 8 digit Client ID / For CDSL, enter 16 digit Client ID				
<b>PLEASE CHANGE MY BID</b>						
<b>4. FROM (AS PER LAST BID OR REVISION)</b>						
<b>Bid Options</b>	<b>No. of Equity Shares Bid</b> (Bid must be in multiples of Bid Lot as advertised) (In Figures)	<b>Price per Equity Share (₹) "Cut-off" (Price in multiples of ₹ 1/- only)</b> (In Figures)				
	0   7   6   5   4   3   2   1	Bid Price   Retail Discount   Net Price   "Cut-off" (Please <input type="checkbox"/> tick)				
Option 1						
(OR) Option 2						
(OR) Option 3						
<b>5. TO (Revised Bid) (Only Retail Individual bidders can bid at "Cut-off")</b>						
<b>Bid Options</b>	<b>No. of Equity Shares Bid</b> (Bids must be in multiples of Bid Lot as advertised) (In Figures)	<b>Price per Equity Share (₹) "Cut-off" (Price in multiples of ₹ 1/- only)</b> (In Figures)				
	0   7   6   5   4   3   2   1	Bid Price   Retail Discount   Net Price   "Cut-off" (Please <input type="checkbox"/> tick)				
Option 1						
(OR) Option 2						
(OR) Option 3						
<b>6. PAYMENT DETAILS</b>						
<b>Additional Amount Paid (₹ in figures)</b>	<b>PAYMENT OPTION : FULL PAYMENT <input type="checkbox"/> PART PAYMENT <input type="checkbox"/></b>					
ASBA Bank A/c No. _____	ASBA Bank Name & Branch _____					
<small>I/WE IN BEHALF OF ME/WO APPLICANT/S AND SIGNER/S HEREBY AGREE AND CONFIRM THE TERMS AND CONDITIONS OF THE BID REVISED FORM AND THE GENERAL DOCUMENT FOR INITIAL PUBLIC ISSUE (IPI) AND I/WE AGREE AND CONFIRM THE TERMS AND CONDITIONS AS GIVEN OVERLEAF (ON BEHALF OF JOINT APPLICANTS, IF ANY) HEREBY CONFIRM THAT I/WE HAVE READ THE INSTRUCTIONS FOR FILLING UP THE BID REVISED FORM GIVEN OVERLEAF.</small>						
<b>7A. SIGNATURE OF SOLE / FIRST BIDDER</b>	<b>7B. SIGNATURE OF ASBA BANK ACCOUNT HOLDER(s) (AS PER BANK RECORDS)</b> <small>I/We authorize the SCSB to do all acts as an account holder to make the Application to Bid.</small>	<b>BROKER / SCSB / DP / RTA STAMP</b> (Acknowledging upload of Bid in Stock Exchange system)				
<b>TEAR HERE</b>						
LOGO	<b>XYZ LIMITED</b> <b>BID REVISION FORM - INITIAL PUBLIC ISSUE - R</b>	<b>Acknowledgement Slip for Broker/SCSB/DP/RTA</b>				
		Bid cum Application Form No. _____				
<b>DPID / CI ID</b>	<b>PAN of Sole / First Bidder</b>					
<b>Additional Amount Paid (₹)</b>	<b>Bank &amp; Branch</b>	<b>Stamp &amp; Signature of SCSB Branch</b>				
ASBA Bank A/c No. _____						
Received from Mr./Ms. _____						
Telephone / Mobile _____	Email _____					
<b>TEAR HERE</b>						
<b>XYZ LIMITED - BID REVISION FORM - INITIAL PUBLIC ISSUE - R</b>	<b>No. of Equity Shares</b>	<b>Option 1</b>	<b>Option 2</b>	<b>Option 3</b>	<b>Stamp &amp; Signature of Broker / SCSB / DP / RTA</b>	<b>Name of Sole / First Bidder</b>
	<b>Bid Price</b>					
	<b>Additional Amount Paid (₹)</b>					
	<b>ASBA Bank A/c No.</b>					
<b>Bank &amp; Branch</b>						Bid cum Application Form No. _____

**4.2.1 FIELDS 1, 2 AND 3: NAME AND CONTACT DETAILS OF SOLE/FIRST APPLICANT, PAN OF SOLE/FIRST APPLICANT & DEPOSITORY ACCOUNT DETAILS OF THE APPLICANT**

Applicants should refer to instructions contained in paragraphs 4.1.1, 4.1.2 and 4.1.3.

**4.2.2 FIELD 4 & 5: BID OPTIONS REVISION 'FROM' AND 'TO'**

- a) Apart from mentioning the revised options in the Revision Form, the Applicant must also mention the details of the share applied for given in his or her Application Form or earlier Revision Form.
- b) In case of revision of Applications by RIIs, Employees and Retail Individual Shareholders, such Applicants should ensure that the Application Amount, should not exceed Rs.200,000/- due to revision and the application may be considered, subject to the eligibility, for allocation under the Non-Institutional Category.

#### **4.2.3 FIELD 6: PAYMENT DETAILS**

- a) Applicants are required to make payment of the full application along with the Revision Form.
- b) Applicant may Issue instructions to block the revised amount in the ASBA Account, to the Designated Branch through whom such Applicant had placed the original Application to enable the relevant SCSB to block the additional Application Amount, if any.

#### **4.2.4 FIELDS 7: SIGNATURES AND ACKNOWLEDGEMENTS**

Applicants may refer to instructions contained at paragraphs 4.1.8 and 4.1.9 for this purpose.

#### **4.3 SUBMISSION OF REVISION FORM/APPLICATION FORM**

Applicants may submit completed application form / Revision Form in the following manner:-

<b>Mode of Application</b>	<b>Submission of Application Form</b>
All Investor Applications	To the Designated Intermediaries

The aforesaid intermediaries shall, at the time of receipt of application, give an acknowledgement to investor, by giving the counter foil or specifying the application number to the investor, as a proof of having accepted the application form, in physical or electronic mode, respectively

### **SECTION 5: OFFER PROCEDURE IN FIXED PRICE ISSUE**

#### **5.1 Applicants may note that there is no Bid cum Application Form in a Fixed Price Issue.**

As the Offer Price is mentioned in the Fixed Price Issue therefore on filing of the Prospectus with the RoC, the Application so submitted is considered as the application form. Applicants may only use the specified Application Form for the purpose of making an Application in terms of the Prospectus which may be submitted through Designated Intermediary.

Applicants may submit an Application Form either in physical/ electronic form to Designated Intermediaries or the Designated Branches of the SCSBs authorizing blocking of funds that are available in the bank account specified in the Application Form only ("ASBA Account"). The Application Form is also made available on the websites of the Stock Exchanges at least one day prior to the Offer Opening Date.

In a fixed price Issue, allocation in the net offer to the public category is made as follows: minimum fifty per cent to Retail Individual Investors; and remaining to (i) individual investors other than Retail Individual Investors; and (ii) other Applicants including corporate bodies or institutions, irrespective of the number of specified securities applied for. The unsubscribed portion in either of the categories specified above may be allocated to the Applicants in the other category.

#### **5.2 GROUNDS FOR TECHNICAL REJECTIONS**

Applicants are advised to note that the Applications are liable to be rejected, inter-alia, on the following technical grounds:-

- Amount paid does not tally with the amount payable for the Equity shares applied for;
- In case of partnership firms, Application for Equity Shares made in the name of the individual partners and no firm as such shall be entitled to apply.
- Application by persons not competent to contract under the Indian Contract Act, 1872, including minors, insane person.

- PAN not mentioned in the Application Form.
- GIR number furnished instead of PAN.
- Applications for lower number of Equity Shares than the minimum specified for that category of investors;
- Applications at a price other than the Fixed Price of the Offer;
- Applications for number of Equity Shares which are not in multiples of 4000;
- Category not ticked;
- Multiple Applications as defined in this Prospectus as such, based on common PAN;
- In case of Applications under power of attorney or by limited companies, corporate, trust etc., relevant documents are not being submitted;
- Signature of sole Applicant is missing;
- Application Forms are not delivered by the Applicants within the time prescribed as per the Application Form, Offer Opening Date advertisement and Prospectus as per the instructions in the Prospectus and Application Forms;
- In case no corresponding record is available with the Depositories that matches the DP ID, the Client ID and the PAN;
- Applications for amounts greater than the maximum permissible amounts prescribed by the regulations;
- Applications by OCBs;
- Applications by US person other than in reliance on Regulation S or “qualified institutional buyers” as defined in Rule 144A under the Securities Act;
- Application not duly signed by the sole applicant;
- Application by any person outside India if not in compliance with applicable foreign and Indian Laws;
- Application that do not comply with the securities laws of their respective jurisdictions are liable to be rejected.
- Applications by persons prohibited from buying, selling or dealing in the shares directly or indirectly by SEBI or any other regulatory authority;
- Application by person not eligible to acquire equity shares of the company in terms of all applicable laws, rules, regulations, guidelines, and approvals.
- Application or revision thereof by QIB Applicants, Non Institutional Applicants where the Application Amount is in excess of Rs. 200000 received after 3.00 pm on the Offer Closing date unless the extended time is permitted by NSE.
- Inadequate funds in the bank account to block the Application Amount specified in the Application Form/Application Form at the time of blocking such Application Amount in the bank account;
- Where no confirmation is received from SCSB for blocking of funds;
- Applications by Applicants not submitted through ASBA process;
- Applications not uploaded on the terminals of the Stock Exchanges; and
- Applications by SCSBs wherein a separate account in its own name held with any other SCSB is not mentioned as the ASBA Account in the Application Form.
- Details of ASBA Account not provided in the Application form
- From one ASBA Account, more than five application are made by applicant.

For details of instructions in relation to the Application Form, Applicants may refer to the relevant section of GID.

**APPLICANT SHOULD NOTE THAT IN CASE THE PAN, THE DP ID AND CLIENT ID MENTIONED IN THE APPLICATION FORM AND ENTERED INTO THE ELECTRONIC APPLICATION SYSTEM OF THE STOCK EXCHANGE BY THE BROKERS DO NOT MATCH WITH PAN, THE DP ID AND CLIENT ID AVAILABLE IN THE DEPOSITORY DATABASE, THE APPLICATION FORM IS LIABLE TO BE REJECTED.**

#### **SECTION 6: OFFER PROCEDURE IN BOOK BUILT ISSUE**

This being the Fixed Price Issue this section is not applicable for this Offer.

#### **SECTION 7: ALLOTMENT PROCEDURE AND BASIS OF ALLOTMENT**

##### **7.1 Basis of Allotment**

Allotment will be made in consultation with SME Platform of NSE (The Designated Stock Exchange). In the event of oversubscription, the allotment will be made on a proportionate basis in marketable lots as set forth here:

- a) The total number of Shares to be allocated to each category as a whole shall be arrived at on a proportionate basis i.e. the total number of Shares applied for in that category multiplied by the inverse of the over subscription ratio (number of applicants in the category x number of Shares applied for).
- b) The number of Shares to be allocated to the successful applicants will be arrived at on a proportionate basis in marketable lots (i.e. Total number of Shares applied for into the inverse of the over subscription ratio).
- c) For applications where the proportionate allotment works out to less than 4000 Equity Shares the allotment will be made as follows:
  - i. Each successful applicant shall be allotted 4000 Equity Shares;
  - ii. The successful applicants out of the total applicants for that category shall be determined by the drawal of lots in such a manner that the total number of Shares allotted in that category is equal to the number of Shares worked out as per (2) above.
- d) If the proportionate allotment to an applicant works out to a number that is not a multiple of 4000 Equity Shares, the applicant would be allotted Shares by rounding off to the lower nearest multiple of 4000 Equity Shares subject to a minimum allotment of 4000 Equity Shares.
- e) If the Shares allotted on a proportionate basis to any category is more than the Shares allotted to the applicants in that category, the balance available Shares for allocation shall be first adjusted against any category, where the allotted Shares are not sufficient for proportionate allotment to the successful applicants in that category, the balance Shares, if any, remaining after such adjustment will be added to the category comprising of applicants applying for the minimum number of Shares. If as a result of the process of rounding off to the lower nearest multiple of 4000 Equity Shares, results in the actual allotment being higher than the shares offered, the final allotment may be higher at the sole discretion of the Board of Directors, upto 110% of the size of the issue specified under the Capital Structure mentioned in this Prospectus.
- f) The above proportionate allotment of shares in an Issue that is oversubscribed shall be subject to the reservation for Retail Individual applicants as described below:
  - i. As per Regulation 43(4) of the SEBI (ICDR) Regulations, as the Retail Individual Investor category is entitled to more than fifty percent on proportionate basis, the retail individual investors shall be allocated that higher percentage.
  - ii. Remaining to Individual applicants other than retail individual investors and Other investors including corporate bodies or institutions, irrespective of the number of specified securities applied for;
  - iii. The unsubscribed portion in either of the categories specified in (a) or (b) above may be available for allocation to the applicants in the other category, if so required.

'Retail Individual Investor' means an investor who applies for shares of value of not more than Rs. 2,00,000. Investors may note that in case of over subscription allotment shall be on proportionate basis and will be finalized in consultation with SME Platform of NSE.

The Executive Director/ Managing Director of the SME Platform of NSE (NSE EMERGE), Designated Stock Exchange in addition to Lead Merchant Banker and Registrar to the Public Offer shall be responsible to ensure that the basis of allotment is finalized in a fair and proper manner in accordance with the SEBI (ICDR) Regulations, 2009.

As per the RBI regulations, OCBs are not permitted to participate in the Issue. There is no reservation for Non Residents, NRIs, FPIs and foreign venture capital funds and all Non Residents, NRI, FPI and Foreign Venture Capital Funds applicants will be treated on the same basis with other categories for the purpose of allocation.

## 7.2 DESIGNATED DATE AND ALLOTMENT OF EQUITY SHARES

- a) **Designated Date:** On the Designated Date, the SCSBs shall transfer the funds represented by allocation of Equity Shares into the Public Issue Account with the Bankers to the Issue.
- b) **Issuance of Allotment Advice:** Upon approval of the Basis of Allotment by the Designated Stock Exchange, the Registrar shall upload the same on its website. On the basis of the approved Basis of Allotment, the Issuer shall pass necessary corporate action to facilitate the Allotment and credit of Equity Shares. Applicants **are advised to instruct their Depository Participant to accept the Equity Shares that may be allotted to them pursuant to the Issue.** Pursuant to confirmation of such corporate actions, the Registrar will dispatch Allotment Advice to the Applicants who have been Allotted Equity Shares in the Offer.
- c) The dispatch of Allotment Advice shall be deemed a valid, binding and irrevocable contract.

- d) Issuer will ensure that: (i) the Allotment of Equity Shares; and (ii) initiate corporate action for credit of shares to the successful Applicants Depository Account will be completed within 5 Working Days of the Offer Closing Date. The Issuer also ensures the credit of shares to the successful Applicant's depository account is completed within 6 Working Days of the Offer Closing Date,

## **SECTION 8: INTEREST AND REFUNDS**

### **8.1 COMPLETION OF FORMALITIES FOR LISTING & COMMENCEMENT OF TRADING**

The Issuer may ensure that all steps for the completion of the necessary formalities for listing and commencement of trading at all the Stock Exchanges are taken within 6 Working Days of the Offer Closing Date. The Registrar to the Issue may give instructions for credit to Equity Shares the beneficiary account with DPs, and dispatch the Allotment Advice within 6 Working Days of the Offer Closing Date.

### **8.2 GROUNDS FOR UNBLOCKING OF FUNDS**

#### **8.2.1 Non Receipt of Listing Permission**

An Issuer makes an application to the Stock Exchange(s) for permission to deal in/list and for an official quotation of the Equity Shares. All the Stock Exchanges from where such permission is sought are disclosed in Prospectus. The Designated Stock Exchange may be as disclosed in the Prospectus with which the Basis of Allotment may be finalized.

If the permissions to deal in and for an official quotation of the Equity Shares are not granted by any of the Stock Exchange(s), the Issuer may forthwith initiate action to unblock the application amount from the Investors accounts. If such money is not repaid within the eight days after the Issuer becomes liable to repay it, then the Issuer and every director of the Issuer who is an officer in default may, on and from such expiry of eight days, be liable to repay the money, with interest at such rate, as prescribed under Section 73 of Companies Act, and disclosed in the Prospectus.

#### **8.2.2 Minimum Subscription**

This Offer is not restricted to any minimum subscription level. This Offer is 100% underwritten.

As per Section 39 of Companies Act, 2013 if the "stated minimum amount" has not been subscribed and the sum payable on application is not received within a period of 30 days from the date of the Prospectus, the application money has to be returned within such period as may be prescribed. If our company does not receive the 100% subscription of the offer through the Offer Document including devolvement of underwriters, if any, within sixty (60) days from the date of closure of the issue, our company shall forthwith unblock the entire application amount received. If there is a delay beyond eighty days after our company becomes liable to pay the amount, our company and every officer in default will, on and from the expiry of this period be jointly and severally liable to repay the money, with interest or other penalty as prescribed under SEBI Regulations, the Companies Act, 2013.

The minimum number of allottees in this Offer shall be 50 shareholders. In case the minimum number of prospective allottees is less than 50 no allotment will be made pursuant to this Offer and the amounts in the ASBA Account shall be unblocked within 6 working days of closure of the Offer.

Further in accordance with Regulation 106(Q) of the SEBI (ICDR) Regulations, our Company shall ensure that the minimum application size in terms of number of specified securities shall not be less than Rs.100000/- (Rupees One Lakh) per application.

The equity shares have not been and will not be registered, listed or otherwise qualified in any other jurisdiction outside India and may not be offered or sold, and applications may not be made by persons in any such jurisdiction, except in compliance without the applicable laws of such jurisdiction.

#### **8.2.3 MINIMUM NUMBER OF ALLOTTEES**

The Issuer may ensure that the number of prospective allottees to whom Equity Shares may be allotted may not be less than 50 failing which the entire application monies may be unblocked forthwith.

### 8.3 Mode of Unblocking of Funds

Within 6 Working Days of the Offer Closing Date, the Registrar to the Issue may give instructions to SCSBs for unblocking the amount in ASBA Account on unsuccessful Application and also for any excess amount blocked on Application.

#### 8.3.1 Mode of making refunds for Applicants

The Registrar to the Issue may instruct the controlling branch of the SCSB to unblock the funds in the relevant ASBA Account for any withdrawn, rejected or unsuccessful ASBA applications or in the event of withdrawal or failure of the Offer.

### 8.4 Interest In Case Of Delay in Allotment

The Issuer may pay interest at the rate of 15% per annum if demat credits are not made to Applicants or instructions for unblocking of funds in the ASBA Account are not dispatched within the 6 Working days of the Offer Closing Date.

The Issuer may pay interest at 15% per annum for any delay beyond 6 working days from the Offer Closing Date, if Allotment is not made.

## SECTION 9: GLOSSARY AND ABBREVIATIONS

*Unless the context otherwise indicates or implies, certain definitions and abbreviations used in this document may have the meaning as provided below. References to any legislation, act or regulation may be to such legislation, act or regulation as amended from time to time.*

Term	Description
Allotment/ Allot/ Allotted	The allotment of Equity Shares pursuant to the Issue to successful Applicants
Allottee	An Applicant to whom the Equity Shares are Allotted
Allotment Advice	Note or advice or intimation of Allotment sent to the Applicants who have been allotted Equity Shares after the Basis of Allotment has been approved by the designated Stock Exchanges
Application Form	The form in terms of which the Applicant should make an application for Allotment in case of issues other than Book Built Issues, includes Fixed Price Issue
Application Supported by Blocked Amount/ (ASBA)/ASBA	An application, whether physical or electronic, used by Applicants to make a Application authorizing an SCSB to block the Bid Amount in the specified bank account maintained with such SCSB
ASBA Account	Account maintained with an SCSB which may be blocked by such SCSB to the extent of the Application Amount of the ASBA Applicant
ASBA Application	A Application made by an ASBA Applicant
Applicant	Prospective Applicants in the Issue who apply through ASBA
Basis of Allotment	The basis on which the Equity Shares may be Allotted to successful Applicants under the Issue
Bid	An indication to make an offer during the Issue Period by a prospective Applicant pursuant to submission of Application Form or during the Anchor Investor Issue Period by the Anchor Investors, to subscribe for or purchase the Equity Shares of the Issuer at a price within the Price Band, including all revisions and modifications thereto.
Offer Closing Date	The date after which the SCSBs may not accept any application for the Offer, which may be notified in an English national daily, a Hindi national daily and a regional language newspaper at the place where the registered office of the Issuer is situated, each with wide circulation. Applicants may refer to the Prospectus for the Offer Closing Date



Term	Description
Offer Opening Date	The date on which the SCSBs may start accepting application for the Offer, which may be the date notified in an English national daily, a Hindi national daily and a regional language newspaper at the place where the registered office of the Issuer is situated, each with wide circulation. Applicants may refer to the Prospectus for the Offer Opening Date
Offer Period	Except in the case of Anchor Investors (if applicable), the period between the Offer Opening Date and the Offer Closing Date inclusive of both days and during which prospective Applicants (other than Anchor Investors) can submit their Application, inclusive of any revisions thereof. The Issuer may consider closing the Offer Period for QIBs one working day prior to the Offer Closing Date in accordance with the SEBI ICDR Regulations, 2009. Applicants may refer to the Prospectus for the Offer Period
Application Amount	The value indicated in the Application Form and payable by the Applicant upon submission of the Application (except for Anchor Investors), less discounts (if applicable).
Application Form	The form in terms of which the Applicant should make an offer to subscribe for or purchase the Equity Shares and which may be considered as the application for Allotment for the purposes of the Prospectus, whether applying through the ASBA or otherwise.
Applicant	Any prospective investor (including an ASBA Applicant) who makes a Application pursuant to the terms of the Prospectus and the Application Form. In case of issues undertaken through the fixed price process, all references to a Applicant should be construed to mean an Applicant
Book Built Process/ Book Building Process/ Book Building Method	The book building process as provided under SEBI ICDR Regulations, 2009,
Broker Centres	Broker centres notified by the Stock Exchanges, where Applicants can submit the Application Form to a Registered Broker. The details of such broker centres, along with the names and contact details of the Registered Brokers are available on the websites of the Stock Exchanges.
Lead Manager/ LM	The Lead Manager to the Issue as disclosed in the Prospectus and the Application Form of the Issuer.
Business Day	Monday to Friday (except public holidays)
CAN/Confirmation of Allotment Note	The note or advice or intimation sent to each successful Applicant indicating the Equity Shares which may be Allotted, after approval of Basis of Allotment by the Designated Stock Exchange
Client ID	Client Identification Number maintained with one of the Depositories in relation to demat account
Collecting Depository Participant or CDP	A depository participant as defined under the Depositories Act, 1996, registered with SEBI and who is eligible to procure Applications at the Designated CDP Locations in terms of circular no. CIR/CFD/POLICYCELL/11/2015 dated November 10, 2015 issued by SEBI
DP	Depository Participant
DP ID	Depository Participant's Identification Number
Depositories	National Securities Depository Limited and Central Depository Services (India) Limited
Demographic Details	Details of the Applicants including the Applicant's address, name of the Applicant's father/husband, investor status, occupation and bank account details
Designated Branches	Such branches of the SCSBs which may collect the Application Forms used by the ASBA Applicants applying through the ASBA and a list of which is available on <a href="http://www.sebi.gov.in/sebiweb/home/list/5/33/0/0/Recognised-Intermediaries">http://www.sebi.gov.in/sebiweb/home/list/5/33/0/0/Recognised-Intermediaries</a> .

Term	Description
Designated CDP Locations	Such locations of the CDPs where Applicant can submit the Application Forms to Collecting Depository Participants. The details of such Designated CDP Locations, along with names and contact details of the Collecting Depository Participants eligible to accept Application Forms are available on the websites of the Stock Exchange i.e. <a href="http://www.nseindia.com">www.nseindia.com</a>
Designated RTA Locations	Such locations of the RTAs where Applicant can submit the Application Forms to RTAs. The details of such Designated RTA Locations, along with names and contact details of the RTAs eligible to accept Application Forms are available on the websites of the Stock Exchange i.e. <a href="http://www.nseindia.com">www.nseindia.com</a>
Designated Date	The date on or after which funds are transferred by the SCSBs to the Public Issue Account of the Issuer.
Designated Stock Exchange	The designated stock exchange as disclosed in the Prospectus of the Issuer
Designated Intermediaries /Collecting Agent	Syndicate Members, Sub-Syndicate/Agents, SCSBs, Registered Brokers, Brokers,the CDPs and RTAs, who are authorized to collect Application Forms from the Applicants, in relation to the Issue
Discount	Discount to the Offer Price that may be provided to Applicants in accordance with the SEBI ICDR Regulations, 2009.
Draft Prospectus	The Draft Prospectus filed with SEBI in case of Fixed Price Issues and which may mention a price
Employees	Employees of an Issuer as defined under SEBI ICDR Regulations, 2009 and including, in case of a new company, persons in the permanent and full time employment of the promoting companies excluding the promoters and immediate relatives of the promoter. For further details Applicant may refer to the Prospectus
Equity Shares	Equity shares of the Issuer
FCNR Account	Foreign Currency Non-Resident Account
First Applicant	The Applicant whose name appears first in the Application Form or Revision Form
FII(s)	Foreign Institutional Investors as defined under the SEBI (Foreign Institutional Investors) Regulations, 1995 and registered with SEBI under applicable laws in India
Fixed Price Issue/Fixed Price Process/Fixed Price Method	The Fixed Price process as provided under SEBI ICDR Regulations, 2009, in terms of which the Issue is being made
FPIs	Foreign Portfolio Investors as defined under the Securities and Exchange Board of India (Foreign Portfolio Investors) Regulations, 2014
FPO	Further public offering
Foreign Venture Capital Investors or FVCIs	Foreign Venture Capital Investors as defined and registered with SEBI under the SEBI (Foreign Venture Capital Investors) Regulations, 2000
IPO	Initial public offering
Issue	Public Issue of Equity Shares of the Issuer including the Offer for Sale if applicable
Issuer/ Company	The Issuer proposing the initial public offering/further public offering as applicable
Offer Price	The final price, less discount (if applicable) at which the Equity Shares may be Allotted in terms of the Prospectus. The Offer Price may be decided by the Issuer in consultation with the Lead Manager(s)

<b>Term</b>	<b>Description</b>
Maximum RII Allottees	The maximum number of RIIs who can be allotted the minimum Application Lot. This is computed by dividing the total number of Equity Shares available for Allotment to RIIs by the minimum Application Lot.
MICR	Magnetic Ink Character Recognition - nine-digit code as appearing on a cheque leaf
Mutual Fund	A mutual fund registered with SEBI under the SEBI (Mutual Funds) Regulations, 1996
NECS	National Electronic Clearing Service
NEFT	National Electronic Fund Transfer
NRE Account	Non-Resident External Account
NRI	NRIs from such jurisdictions outside India where it is not unlawful to make an offer or invitation under the Issue and in relation to whom the Prospectus constitutes an invitation to subscribe to or purchase the Equity Shares
NRO Account	Non-Resident Ordinary Account
Net Offer	The Offer less reservation portion
Non-Institutional Investors or NIIs	All Applicants, including sub accounts of FIIs registered with SEBI which are foreign corporate or foreign individuals and FPIs which are Category III foreign portfolio investors, that are not QIBs or RIBs and who have Applied for Equity Shares for an amount of more than ` 200,000 (but not including NRIs other than Eligible NRIs)
Non-Institutional Category	The portion of the Issue being such number of Equity Shares available for allocation to NIIs on a proportionate basis and as disclosed in the Prospectus and the Application Form
Non-Resident	A person resident outside India, as defined under FEMA and includes Eligible NRIs, FIIs, FPIs and FVCIs
OCB/Overseas Corporate Body	A company, partnership, society or other corporate body owned directly or indirectly to the extent of at least 60% by NRIs including overseas trusts, in which not less than 60% of beneficial interest is irrevocably held by NRIs directly or indirectly and which was in existence on October 3, 2003 and immediately before such date had taken benefits under the general permission granted to OCBs under FEMA
Offer for Sale	Public offer of such number of Equity Shares as disclosed in the Prospectus through an offer for sale by the Selling Shareholder
Other Investors	Investors other than Retail Individual Investors in a Fixed Price Issue. These include individual applicants other than retail individual investors and other investors including corporate bodies or institutions irrespective of the number of specified securities applied for.
PAN	Permanent Account Number allotted under the Income Tax Act, 1961
Pricing Date	The date on which the Issuer in consultation with the Lead Manager(s), finalize the Offer Price
Prospectus	The prospectus to be filed with the RoC in accordance with Section 60 of the Companies Act, 1956 read with section 26 of Companies Act 2013 after the Pricing Date, containing the Offer Price, the size of the Issue and certain other information
Public Issue Account	An account opened with the Banker to the Issue to receive monies from the Escrow Account and from the ASBA Accounts on the Designated Date
QIB Category	The portion of the Issue being such number of Equity Shares to be Allotted to QIBs on a proportionate basis

Term	Description
Qualified Institutional Buyers or QIBs	As defined under SEBI ICDR Regulations, 2009
RTA	Registrar to the Issue and Share Transfer Agent
Registered Broker	Stock Brokers registered with the Stock Exchanges having nationwide terminals, other than the members of the Syndicate
Registrar to the Issue/RTI	The Registrar to the Issue as disclosed in the Prospectus and Application Form
Reserved Category/ Categories	Categories of persons eligible for making application/bidding under reservation portion
Reservation Portion	The portion of the Issue reserved for category of eligible Applicants as provided under the SEBI ICDR Regulations, 2009
Retail Individual Investors / RIIs	Investors who applies or bids for a value of not more than Rs. 200,000.
Retail Individual Shareholders	Shareholders of a listed Issuer who applies or bids for a value of not more than Rs. 200,000.
Retail Category	The portion of the Issue being such number of Equity Shares available for allocation to RIIs which shall not be less than the minimum bid lot, subject to availability in RII category and the remaining shares to be allotted on proportionate basis.
Revision Form	The form used by the Applicant in an issue through Book Building process to modify the quantity of Equity Shares and/or bid price indicates therein in any of their Application Forms or any previous Revision Form(s)
RoC	The Registrar of Companies
SEBI	The Securities and Exchange Board of India constituted under the Securities and Exchange Board of India Act, 1992
SEBI ICDR Regulations, 2009	The Securities and Exchange Board of India (Issue of Capital and Disclosure Requirements) Regulations, 2009
Self Certified Syndicate Bank(s) or SCSB(s)	A bank registered with SEBI, which offers the facility of ASBA and a list of which is available on <a href="http://www.sebi.gov.in/cms/sebi_data/attachdocs/1316087201341.html">http://www.sebi.gov.in/cms/sebi_data/attachdocs/1316087201341.html</a>
Specified Locations	Refer to definition of Broker Centers
Stock Exchanges/ SE	The stock exchanges as disclosed in the Prospectus of the Issuer where the Equity Shares Allotted pursuant to the Issue are proposed to be listed
Syndicate	The Book Running Lead Manager(s) and the Syndicate Member
Syndicate Agreement	The agreement to be entered into among the Issuer, and the Syndicate in relation to collection of the Bids in this Issue (excluding Application from ASBA Applicants)
Syndicate Member(s)/SM	The Syndicate Member(s) as disclosed in the Prospectus
Underwriters	The Lead Manager(s)
Underwriting Agreement	The agreement dated entered into between the Underwriters and our company.

Term	Description
Working Day	Any day, other than 2nd and 4th Saturday of the month, Sundays or public holidays, on which commercial banks in India are open for business, provided however, with reference to announcement Issue Period, "Working Days" shall mean all days, excluding Saturdays, Sundays and public holidays, which are working days for commercial banks in India.

## **RESTRICTIONS ON FOREIGN OWNERSHIP OF INDIAN SECURITIES**

Foreign investment in Indian securities is regulated through the Industrial Policy, 1991 of the Government, the FDI Policy (as defined below) and FEMA. While the Industrial Policy, 1991 prescribes the limits and the conditions subject to which foreign investment can be made in different sectors of the Indian economy, FEMA regulates the precise manner in which such investment may be made. Under the Industrial Policy, unless specifically restricted, foreign investment is freely permitted in all sectors of Indian economy up to any extent and without any prior approvals, but the foreign investor is required to follow certain prescribed procedures for making such investment. The government bodies responsible for granting foreign investment approvals are FIPB and the RBI.

The Government has from time to time made policy pronouncements on FDI through press notes and press releases. The Department of Industrial Policy and Promotion, Ministry of Commerce and Industry, Government of India (“DIPP”), issued consolidated FDI Policy, which with effect from June 07, 2016 consolidates and supersedes all previous press notes, press releases and clarifications on FDI issued by the DIPP that were in force and effect as on June 7, 2016. The Government proposes to update the consolidated circular on FDI Policy once every year and therefore, the Consolidation FDI Policy will be valid until the DIPP issues an updated circular.

### **Subscription by foreign investors (NRIs/FPIs)**

FPIs are permitted to subscribe to Equity Shares of an Indian Company in a public offer without the prior approval of the RBI, so long as the price of the Equity Shares to be issued is not less than the price at which the Equity Shares are issued to residents. SEBI registered FPIs have been permitted to purchase shares of an Indian company through offer, subject to total FPI investment being within the individual FPI/sub account investment limit of 10 per cent subject to the total sectoral cap of all FPIs/sub-accounts put together being 24 per cent of the paid-up capital of the Indian company.

The transfer of shares between an Indian resident and a Non-resident does not require prior approval of FIPB or RBI, subject to fulfillment of certain conditions as specified by DIPP / RBI, from time to time. Such conditions include (i) the activities of the investee company are under the automatic route under the foreign direct investment (“FDI”) Policy and the non-resident shareholding is within the sectoral limits under the FDI policy; and (ii) the pricing is in accordance with the guidelines prescribed by the SEBI/RBI. Investors are advised to refer to the exact text of the relevant statutory provisions of law before investing and / or subsequent purchase or sale transaction in the Equity Shares of Our Company.

### **Representation from the Applicants**

No person shall make an application in the Offer, unless such person is eligible to acquire Equity Shares of our Company in accordance with applicable laws, rules, regulations, guidelines and approvals.

Investors that make application under the Offer will be required to confirm and will be deemed to have represented to our Company, the Underwriters, and their respective directors, officers, agents, affiliates and representatives, as applicable, that they are eligible under all applicable laws, rules, regulations, guidelines and approvals to acquire Equity Shares of our Company and will not offer, sell, pledge or transfer the Equity Shares of our Company to any person who is not eligible under applicable laws, rules, regulations, guidelines and approvals to acquire Equity Shares of our Company. Our Company, the Underwriters and their respective directors, officers, agents, affiliates and representatives, as applicable, accept no responsibility or liability for advising any investor on whether such investor is eligible to acquire Equity Shares of our Company.

There is no reservation for Non Residents, NRIs, FPIs, foreign venture capital funds, multi-lateral and bilateral development financial institutions and any other foreign investor. All Non Residents, NRIs, FPIs and foreign venture capital funds, multi-lateral and bilateral development financial institutions and any other foreign investor applicants will be treated on the same basis with other categories for the purpose of allocation.

As per the existing policy of the Government of India, OCBs also cannot participate in any Public Offer.

The Equity Shares have not been and will not be registered under the Securities Act or any state securities laws in the United States and may not be offered or sold within the United States or to, or for the account or benefit of, “U.S. persons” (as defined in Regulation S promulgated under the Securities Act), except pursuant to an exemption from, or in a transaction not subject to, the

registration requirements of the Securities Act. Accordingly, the Equity Shares are only being offered and sold outside the United States to certain persons in offshore transactions in compliance with Regulation S under the Securities Act.

Our Company, Selling Shareholders, LM and the Offer Management Team are not making any selling efforts in any jurisdiction outside India.

The Equity Shares have not been and will not be registered, listed or otherwise qualified in any other jurisdiction outside India and may not be offered or sold, and applications may not be made by persons in any such jurisdiction, except in compliance with the applicable laws of such jurisdiction.

The above information is given for the benefit of the Applicants. The Company and the LM are not liable for any amendments or modification or changes in applicable laws or regulations, which may occur after the date of the Prospectus. Applicants are advised to make their independent investigations and ensure that the number of Equity Shares applied for do not exceed the applicable limits under laws or regulations.

### SECTION VIII - MAIN PROVISIONS OF ARTICLES OF ASSOCIATION OF OUR COMPANY

Pursuant to Schedule I of the Companies Act, and the SEBI ICDR Regulations, the Main provisions of the Articles of Association relating to voting rights, dividend, lien, forfeiture, restrictions on transfer and Transmission of equity shares or debentures, their consolidation or splitting are as provided below. Each provision below is numbered as per the corresponding article number in the articles of association and defined terms herein have the meaning given to them in the Articles of Association.

ARTICLE NO.	INTERPRETATION	HEADING
1.	The regulations contained in Table F in the First Schedule to the Companies Act, 2013 shall apply to the Company except in so far as such regulations are embodied in these following Articles.	<b>CONSTITUTION</b>
2.	In these presents, the following words and expression shall have, the following meanings unless excluded by the subject or context; words importing the singular shall include the plural and vice versa; words importing the masculine gender shall include the feminine gender and vice versa; and words importing person shall include bodies corporate.	<b>INTERPRETATION</b>
	a) "The Act" means Companies Act, 2013 its rules and any statutory modifications or reenactments thereof and every relevant Companies Act for the time being in force concerning Joint Stock Companies; and the word "Section" relates to the relevant Section in the Companies Act, 2013.	<b>THE ACT AND SECTION</b>
	b) "The Company" or "This Company" means KRISHANA PHOSCHEM LIMITED.	<b>'THE COMPANY' OR 'THIS COMPANY'</b>
	c) "Auditors" means Auditor or Auditors for the time being of the Company	<b>AUDITORS</b>
	d) "The Board" or "Board of Directors" means a meeting of the Directors duly called and constituted, as the case may be, the Directors assembled as a Board or the requisite number of Directors entitled to pass a circular resolution in accordance with these Articles.	<b>THE BOARD OR BOARD OF DIRECTORS</b>
	e) "Debenture" includes debenture stocks	<b>IN WRITING</b>
	f) "In Writing" includes printing, lithography, typewriting and other usual substitutes for writing.	<b>Depositories Act,1996</b>
	g) "Members" means a member as defined under Section 2(55) of the Act.	<b>MEMBERS</b>
	h) "Month" shall mean Calendar Month	<b>MONTH</b>
	i) "Office" means the Registered Office for the time being of Company	<b>OFFICE</b>
	j) "Person" shall include any corporation as well as individual.	<b>PERSON</b>
	k) "These Presents or Regulations" mean these Articles of Association as originally framed or altered from time to time including the Memorandum where the context so requires.	<b>THESE PRESENTS OR REGULATIONS</b>
	l) "The Seal" means the Common Seal for the time being of Company	<b>THE SEAL</b>
	m) "Secretary" means any individual possessing qualification prescribed for the time being by any rule made under the Act and appointed by the Board to perform the duties which may be performed by a Secretary under the Act and any other ministerial or administrative duties.	<b>SECRETARY</b>
	n) "Special Resolution" shall have the meaning assigned therein by Section 114 of the act.	<b>SPECIAL RESOLUTION</b>
	o) "Beneficial Owner" shall mean the beneficial owner as defined in clause (a) of sub-section (1) of Section 2 of the Depositories Act, 1996.	<b>BENEFICIAL OWNER*</b>
	q) "Depository" shall mean Depository as defined under clause (e) of subsection (1)	<b>DEPOSITORIES ACT,</b>



	of Section 2 of the Depositories Act, 1996	1996
3	<p>(a) The Authorized Share Capital of the Company shall be as prescribed in Clause V of the Memorandum of Association of the company</p> <p>(b) Subject to the provisions of the Act and these Articles, the shares in the capital of the Company shall be under the control of the Directors who may issue, allot or otherwise dispose of the same or any of them to such persons, in such proportion and on such terms and conditions and either at a premium or at par and at such time as they may from time to time think fit. Further provided that the option or right to call of shares shall not be given to any person except with the sanction of the Company in general meeting</p>	<b>SHARE CAPITAL</b>
4	The Company in General Meeting, may from time to time, by an Ordinary Resolution increase the capital by the creation of new shares, the increase to be of such aggregate amount and to be divided into shares of such respective amounts as the resolution shall prescribe. Subject to the provisions of the Act, any share of the original or increased capital shall be issued upon such terms and conditions and with such rights and privileges annexed thereto, as the General Meeting resolving upon the creation thereof shall direct, and if no direction be given, as the Directors shall determine and in particular, such shares may be issued with a preferential or qualified right to dividends, and in the distribution of assets of the Company in conformity with Sections 47 of the Act.	<b>INCREASE IN CAPITAL</b>
5.	Except so far as otherwise provided by the conditions of issue or by these resents, any capital raised by the creation of new shares shall be considered as part of the existing capital and shall be subject to the provisions herein contained, with reference, to the payment of calls and installments, forfeiture, lien, surrender, transfer and transmission, voting and otherwise.	<b>NEW CAPITAL SAME AS EXISTING CAPITAL</b>
6.	Subject to the provision of Section 55 of the Act, the Company shall have the power to issue Preference shares which are, liable to be redeemed and the resolution authorizing such issue shall prescribe the manner, terms and conditions of redemption.	<b>REDEEMABLE PREFERENCE SHARES</b>
7.	<p>On the issue of Redeemable Preference Shares under the provisions of Article 6 hereof the following provisions shall take effect:</p> <p>a) No such shares shall be redeemed except out of the profits of the Company which would otherwise be available for dividend or out of other proceeds of fresh issue of shares made for the purpose of redemption</p> <p>b) no such shares shall be redeemed unless they are fully paid.</p> <p>c) the premium, if any, payable on redemption must have been provided for out of the profits of the Company or the Company's Share Premium Account before the shares are redeemed.</p> <p>d) Where any such shares are redeemed otherwise than out of the proceeds of a fresh issue there shall out of profits which would otherwise have been available for dividends be transferred to a reserve fund, to be called the "Capital Redemption Reserve Account" a sum equal to the nominal amount of the shares redeemed and the provision of the Act relating to the reduction of the share capital of the Company shall except as provided in Section 55 of the Act, apply as if the Capital Redemption Reserve Account were paid-up share capital of the Company.</p>	<b>PROVISION TO APPLY ON ISSUE OF REDEEMABLE PREFERENCE SHARES</b>

8	<p>a) The Company may (subject to the provisions of Sections 52, 55, 66 the Act) from time to time by Special Resolution reduce its capital and any Capital Redemption Reserve Account or Premium Account in any manner for the time being authorized by law, and in particular capital may be paid off on the footing that it may be called upon again or otherwise. This Article is not to derogate from any power the Company would have, if it were omitted</p> <p>b) Notwithstanding anything contained in sub-clause (a) above, in the event it is permitted by the Law and subject to such limits, terms, conditions and consents as may be prescribed and laid down for the purpose, the Company shall have the power to buy-back its own shares, whether or not there is any consequent reduction of Capital. If and to the extent permitted by Law, the Company shall also have the power to re-issue the shares so bought back.</p>	<b>REDUCTION OF CAPITAL</b>
9.	<p>Subject to the provisions of Section 61 of the Act, the Company in general meeting may, from time to time, consolidate all or any of its share capital into shares of larger amount than its existing shares or subdivide its shares, or any of them into shares of smaller amount than is fixed by the memorandum and the resolution whereby any share is sub-divided, may determine that, as between the holders of the shares resulting from such sub-division one or more of such shares shall have some preference or special advantage as regards dividend, capital or otherwise over or as compared with the others or other. Subject to as aforesaid the Company in general meeting may also cancel shares which have not been taken or agreed to be taken by any person and diminish the amount of its share capital by the amount of the shares so cancelled.</p>	<b>SUB-DIVISION, CONSOLIDATION AND CANCELLATION OF SHARES</b>
10.	<p>If at any time, share capital of the company, by reason of the issue of Preference Shares or otherwise is divided into different classes of shares, all or any of the rights and privileges attached to any class (unless otherwise provided, by the terms of issue of the shares of that class) may subject to the provisions of Sections 48 of the Act and whether or not the Company is being wound-up be varied, modified commuted, affected or abrogated with the consent in writing of the holders of three fourths of the issued shares of that class or with the sanction of a Special Resolution passed at a separate general meeting of the holders of the shares of that class. This Article shall not derogate from any power which the Company would have if these Articles were, omitted. The provision of these articles relating to general meetings shall mutatis mutandis, apply to every such separate meeting but so that if at any adjourned meeting of such holders a quorum as defined above is not present, those persons who are present shall be the quorum.</p>	<b>MODIFICATION OF RIGHTS</b>
11.	<p>Subject to the provisions of Sections 66 (inclusive) of the Act, the Board may accept from any member on such terms and conditions as shall be agreed a surrender of all or any of his shares</p>	<b>BOARD MAY ACCEPT SURRENDER OF SHARES</b>
12.	<p>The Company shall keep a Register and Index of Members in accordance with Section 88 of the Act and the details of the members holding shares both in material and dematerialised form in any media as permitted by law including electronic media. The Company shall also be entitled to keep in any state or country outside India a Branch Register of Members resident in that state or country.</p>	<b>SHARES AND CERTIFICATES REGISTER AND INDEX OF MEMBERS</b>
13.	<p>a) The shares in the capital shall be numbered progressively according to their several denominations, and except in the manner hereinbefore mentioned no share shall be sub-divided. Every forfeited or surrendered share shall continue to bear the number by which the same was originally distinguished.</p> <p>b) Nothing contained in sub-clause (a) above, shall apply to shares held in the Depository form</p>	<b>SHARES TO BE NUMBERED PROGRESSIVELY AND NO SHARE TO BE SUB- DIVIDED</b>

14. The Board may at any time increase the subscribed capital of the Company by issue of new shares out of the unissued part of the Share Capital in the original or subsequently created capital, but subject to Section 62 of the Act, and subject to the following conditions namely:

I. (a) Such further shares shall be offered to the persons who, at the date of the offer, are holder of the equity shares of the Company in proportion, as nearly as circumstances admit, to the capital paid up on those shares at that date.

(b) The offer aforesaid shall be made by notice specifying the number of shares offered and limiting a time not being less than twenty-one days, from the date of the offer within which the offer, if not accepted, will be deemed to have been declined.

(c) The offer aforesaid shall be deemed to include a right exercisable by the person concerned to renounce the shares offered to him or any of them in favour of any other person and the notice referred to in clause (b) shall contain a statement of this right.

d) After the expiry of the time specified in the notice aforesaid, or in respect of earlier intimation from the person to whom such notice is given that he declines to accept the shares offered, the Board may dispose of them in such manner as it thinks most beneficial to the Company.

II. The Directors may, with the sanction of the Company in General Meeting by means of a special resolution, offer and allot shares to any person at their discretion by following the provisions of section 62 of the Act and other applicable provisions, if any.

III. Nothing in this Article shall apply to the increase in the subscribed capital of the Company which has been approved by:

(a) A Special Resolution passed by the Company in General Meeting before the issue of the debentures or the raising of the loans, and

(b) The Central Government before the issue of the debentures or raising of the loans or is in conformity with the rules, if any, made by that Government in this behalf.

**FURTHER ISSUE OF  
CAPITAL**

15. Subject to the provisions of the Act and these Articles, the shares in the capital of the Company for the time being (including any shares forming part of any increased capital of the Company) shall be under the control of the Board who may allot the same or any of them to such persons, in such proportion and on such terms and conditions and either at a premium or at par or at a discount (subject to compliance with the provisions of the Act) and at such terms as they may, from time to time, think fit and proper and with the sanction of the Company in General Meeting by a Special Resolution give to any person the option to call for or be allotted shares of any class of the Company, either at par, at a premium or subject as aforesaid at a discount, such option being exercisable at such times and for such consideration as the Board thinks fit unless the Company in General Meeting, by a Special Resolution, otherwise decides. Any offer of further shares shall be deemed to include a right, exercisable by the person to whom the shares are offered, to renounce the shares offered to him in favour of any other person.

**SHARES UNDER  
CONTROL OF  
DIRECTORS**

16. In addition to and without derogating from the powers for that purpose conferred on the Board under Articles 14 and 15, the Company in General Meeting, by a Special Resolution, may determine that any share (whether forming part of the original capital or of any increased capital of the Company) shall be offered to such persons (whether members or holders of debentures of the Company or not), giving them the option to call or be allotted shares of any class of the Company either at a premium or at par or at a discount, (subject to compliance with the provisions of Section 53) such

**POWER ALSO TO  
COMPANY IN  
GENERAL MEETING  
TO ISSUE SHARES**

option being exercisable at such times and for such consideration as may be directed by a Special Resolution at a General Meeting of the Company or in General Meeting and may take any other provisions whatsoever for the issue, allotment or disposal of any shares.	
17. Subject to these Articles and the provisions of the Act, the Board may issue and allot shares in the capital of the Company as payment or in consideration or as part payment or in part consideration of the purchase or acquisition of any property or for services rendered to the Company in the conduct of its business and shares which may be so issued or allotted shall be credited or deemed to be credited as fully paid up shares. As regards all allotments, from time to time made, the Board shall duly comply with Section 39 of the Act.	<b>ISSUE OF SHARES FOR CONSIDERATION OTHER THAN CASH</b>
18. Any application signed by or on behalf of an applicant for shares in the Company, followed by an allotment of any shares therein, shall be an acceptance of shares within the meaning of these Articles, and every person who thus or otherwise accepts any shares and whose name is on the Register shall for the purpose of these Articles be a Member.	<b>ACCEPTANCE OF SHARES</b>
19. The money, if any, which the Board shall, on the allotment of any shares being made by them, require or direct to be paid by way of deposit, call or otherwise in respect of any shares allotted by them shall, immediately on the insertion of the name or the name of the allottee in the Register of Members as the name of the holder of such shares, become a debt due to and recoverable by the Company from the allottee thereof and shall be paid by him accordingly.	<b>DEPOSIT AND CALL ETC., TO BE A DEBT PAYABLE IMMEDIATELY</b>
20. Amount paid in advance of calls may entail a right for interest but will not confer a right to dividend or to participate in the profits of the company.	<b>CALL IN ADVANCE</b>
21. Every, member, or his heirs, executors or administrators, shall pay to the Company the portion of the capital represented by his share or shares which may, for the time being, remain unpaid thereon, in such amount, at such time or times, and in such manner as the Company's, regulations require or fix for the payment thereof.	<b>LIABILITY OF MEMBERS</b>
22. The company will have a first and paramount lien upon all the shares (other than full paid-up shares) registered in the name of each member (whether solely or jointly with others) and upon the proceeds of sale thereof for all moneys whether presently payable or not) called or payable at fixed time in respect of such shares and no equitable interest in any share shall be created except upon the footing and condition that this Article will have full effect. And such lien shall extend to all dividends and bonus from time to time declared in respect of such shares. Unless otherwise agreed the registration of a transfer of shares shall operate as a waiver of the company's lien if any on such shares. The Directors may at any time declare any shares wholly or in part to be exempt from the provisions of this clause.	<b>LIABILITY OF MEMBERS</b>
23. a) Every member or allottee of shares shall be entitled without payment, to receive one certificate specifying the name of the person in whose favour it is issued, the shares to which it relates and the amount paid-up thereon. Such certificate shall be issued only in pursuance of a resolution passed by the Board and on surrender to the Company of its letter of allotment or its fractional coupons of requisite value, save in cases of issue of letters of acceptance or of renunciation or in case of issue of bonus shares.	<b>SHARE CERTIFICATES</b>
Every such certificate shall subject to the provisions of the Act be issued within a period of two months from the date of allotment and within fifteen days after application for registration of the transfer of any share or debenture under the seal of the company, which shall be affixed in the presence of two Directors or persons acting on behalf of the Directors under duly registered power of attorney and the Secretary or some other person appointed by the Board for the purpose, and two directors or their Attorneys and the Secretary or other person shall sign the share certificate, provided that if the composition of the Board permits of it, at least one of the aforesaid two Directors shall be a person other than a Managing or a whole-time	<b>SHARE CERTIFICATES</b>

Director. Particulars of every share certificate issued shall be entered in the Register of Members against the name of the person, to whom it has been issued, indicating the date of issue.

b) Any two or more joint allottees of a share shall for the purpose of this Article, be treated as a single member, and the certificate of any share, which may be the subject of joint ownership, may be delivered to anyone of such joint owners on behalf of all of them. For any further certificate the Board shall be entitled, but shall not be bound to prescribe charge not exceeding Rupee one. The Company shall comply with the provisions of the Act.

c) A Director may sign a share certificate by affixing his signature thereon by means of any machine, equipment or other mechanical means, such as engraving in metal or lithography, but not by means of a rubber stamp, provided that the Director shall be responsible for the safe custody of such machine, equipments or other material used for the purpose.

d) Share/Debenture Certificates shall be issued in marketable lots and where Share/Debenture Certificate are issued for either more or less than marketable lots, subdivision/ consolidation into marketable lots shall be done free of charge.

e) The Company shall be entitled to dematerialise its shares, debentures and other securities pursuant to the Depositories Act, 1996 and to offer its shares, debentures and other securities for subscription in a dematerialised form.

f) Notwithstanding anything contained in these articles, the Board shall not accept application(s) for subdivision or consolidation of shares or debentures or bonds into denominations of less than marketable lots except when such a subdivision or consolidation is required to be made to comply with a statutory order or an order of a competent court of law or a request from a member to convert his holding of odd lots of shares or debentures or bonds into transferable/marketable lot subject, however to verification by the Company.

---

24. a) No certificate of any share or shares shall be issued either in exchange for those which are subdivided or consolidated or in replacement of those which are defaced, torn or old, decrepit, worn out or where the cages on the reverse for recording transfer have been duly utilized, unless the certificate in lieu of which it is issued is surrendered to the Company.

b) When a new share Certificate has been issued in pursuance of clause (a) of this Article, it shall state on the face of it and against the stub or counterfoil to the effect that it is "issued in lieu of share certificate No. sub-divided/replaced/on consolidation of shares".

c) If a share certificate is lost or destroyed, a new certificate in lieu thereof shall be issued only with the prior consent of the Board and on such terms, if any, as to evidence and indemnity as to the payment of out-of-pocket expenses incurred by the Company in investigating evidence, as the Board thinks fit.

d) When a new share certificate has been issued in pursuance of clause (c) of this Article, it shall state on the face of it and against the stub or counterfoil to the effect that it is "duplicate" issued in lieu of share certificate No. The word "Duplicate" shall be stamped or punched in bold letters across the face of the share certificate. e) Where a new share certificate has been issued in pursuance of clause (a) or clause (c) of this Article, particulars of every such share certificate shall be entered in a Register of Renewed and Duplicate Certificates indicating against the names of the persons to whom the certificate is issued, the number and date of issue of the share certificate in

---

**RENEWAL OF SHARE  
CERTIFICATE**

lieu of which the new certificate is issued, and the necessary changes indicated in the Register of Members by suitable cross reference in the "Remarks" column.

f) All blank forms to be issued for issue of share certificate shall be printed and the printing shall be done only on the authority of a resolution of the Board. The blank forms shall be consecutively machine numbered and the forms and the blocks, engravings, facsimiles and hues relating to the printing of such forms shall be kept in the custody of the Secretary or of such other person as the Board may appoint for the purpose and the Secretary or the other person aforesaid shall be responsible for rendering an account of those forms to the Board.

g) The Managing Director of the Company for the time being or if the Company has no Managing Director, every Director of the Company shall be responsible for the maintenance, preservation and safe custody of all books and documents relating to the issue of share certificates except the blank forms of share certificate referred to in clause (f) of this Article.

h) All books referred to in clause (g) of this Article shall be preserved in good order permanently.

25. If any share stands in the names of two or more persons, the person first named in the Register shall, as regards receipts of dividends or bonus or service of notice and all or any other matter connected with the Company, except voting at meetings, and the transfer of the shares, be deemed the sole holder thereof but the joint-holders of a share shall be severally as well as jointly liable for the payment of all installment and calls due in respect of such share and for all incidents thereof according to the Company's regulations.

**THE FIRST NAMED OF  
JOINT-HOLDERS  
DEEMED SOLE  
HOLDER**

26. Except as ordered by a Court of competent jurisdiction or as by law required, the Company shall not be bound to recognize any equitable, contingent, future or partial interest in any share, (except only as is by these Articles otherwise expressly provided) any right in respect of a share other than an absolute right thereto, in accordance with these Articles, in the person from time to time registered as the holder thereof, but the Board shall be at liberty at their sole discretion to register any share in the joint names of any two or more person or the survivor or survivors of them.

**COMPANY NOT  
BOUND TO  
RECOGNISE ANY  
INTEREST IN SHARE  
OTHER THAN THAT  
OF REGISTERED  
HOLDER**

27. a) Notwithstanding anything herein contained, a person whose name is at any time entered in the Register of Members of the Company as the holder of a share in the Company, but who does not hold the beneficial interest in such share, shall, within such time and in such form as may be prescribed, make a declaration to the Company specifying the name and other particulars of the person or persons who hold the beneficial interest in such share in such manner as may be provided in Section 89 of the Act.

**DECLARATION BY  
PERSON NOT  
HOLDING  
BENEFICIAL  
INTEREST IN ANY  
SHARE**

b) A person who holds a beneficial interest in a share or a class of shares of the Company shall, within the time prescribed, after his becoming such beneficial owner, make a declaration to the Company specifying the nature of his interest, particulars of the person in whose name the shares stand in the Register of Members of the Company and such other particulars as may be prescribed as provided in Section 89 of the Act.

c) Whenever there is a change in the beneficial interest in a share referred to above, the beneficial owner shall, within the time prescribed from the date of such, change make a declaration to the Company in such form and containing such particulars as may be prescribed as provided in Section 89 of the Act.

d) Notwithstanding anything contained in the Act and Articles hereof, where any

	<p>declaration referred to above is made to the Company, the Company shall make a note of such declaration in the Register of Members and file within the time prescribed from the date of receipt of the declaration a return in the prescribed form with the Registrar with regard to such declaration.</p> <p>e) Nothing contained in Section 89 of the Companies Act, 2013 shall apply to transfer of security effected by the transferor and the transferee both of whom are entered as beneficial owners in the records of a depository</p>	
28.	<p>Subject to the provision of the Act, the Company may at any time pay a commission to any person in consideration of his subscribing or agreeing to subscribe (whether absolutely or conditionally) for any shares or debentures in the Company or procuring, or agreeing to procure subscription (whether absolute or conditional) for any share or debentures in the Company, but so that the commission shall not exceed in the case of shares five per cent of the price at which the shares are issued and in the case of debentures two and a half per cent of the price at which the debentures are issued. Such commission may be satisfied by payment of cash or by allotment of fully or partly paid shares or partly in one way and partly in the other.</p>	<p><b>UNDERWRITING AND BROKERAGE COMMISSION MAY BE PAID</b></p>
29.	<p>Subject to provisions of the act, The Company may pay a reasonable sum for brokerage</p>	<p><b>BROKERAGE</b></p>
30.	<p>Where any shares are issued for the purpose of raising money to defray the expenses of the construction of any work or building or the provision of any plant which cannot be made profitable for a lengthy period, the Company may pay interest on so much of that share capital as is for the time being paid up, for the period, at the rate and subject to the conditions and restrictions provided by of the Act and may charge the same to capital as part of the cost of construction of the work or building or the provision of plant.</p>	<p><b>INTEREST OUT OF CAPITAL INTEREST MAY BE PAID OUT OF CAPITAL</b></p>
31.	<p>The Company shall keep a Register of Transfers and therein shall fairly and distinctly enter particulars of every transfer or transmission of any share.</p> <p>Provided however that the Company will not decline to register or acknowledge any transfer of shares on the ground of the transferor being either alone or jointly with any other person or persons indebted to the Company on any account whatsoever.</p>	<p><b>TRANSFER AND TRANSMISSION OF SHARES AND REGISTER OF TRANSFERS</b></p>
32.	<p>A transfer of shares in the Company shall be by an instrument of transfer in writing in the prescribed form as prescribed in rules made under sub section (1) of section 56 and shall be duly stamped and delivered to the Company in accordance with the provisions of the Act.</p>	<p><b>INSTRUMENT OF TRANSFER</b></p>
33.	<p>a) The instrument of transfer shall be accompanied by such evidence as the board may require to prove the title of transferor and his right to transfer the shares and every registered instrument of transfer shall remain in the custody of the company until destroyed by order of the Board. The transferor shall be deemed to be the older of such shares until the name of the transferee shall have been entered in the register of Members in respect thereof. Before the registration of transfer the certificate of the shares must be delivered to the Company.</p> <p>b) The company shall affect transfer, transmission, sub-division or consolidation within 15 days from the date of lodgment of documents.</p> <p>c) Notwithstanding anything contained in the Articles of Association, in the case of transfer of shares or other marketable securities, where the Company has not issued any certificates and where such shares or securities are being held in any electronic and fungible form, the provisions of the Depositories Act, 1996 shall apply.</p>	<p><b>TRANSFER FORM TO BE COMPLETED AND PRESENTED TO THE COMPANY</b></p>
34.	<p>The Board shall have power on giving not less than seven days previous notice by advertisement in some newspaper circulating in the district in which the office of the Company is situated to close the Transfer Books, Register of Members or Register of Debenture holders at such time or times and for such period or periods, not exceeding</p>	<p><b>TRANSFER BOOKS AND REGISTER OF MEMBERS WHEN CLOSED</b></p>

	thirty days at a time and not exceeding in the aggregate forty-five days in each year.	
35.	Where in the case of partly paid shares, an application for registration is made by the transferor; the Company shall give notice of the application to the transferee in accordance with the provisions of the Act.	<b>NOTICE OF APPLICATION WHEN TO BE GIVEN</b>
36.	In case of the death of any one or more of the persons named in the Register of Members as the joint holders of any share, the survivor or survivors shall be the only persons recognized by the Company as having any title to or interest in such share, but nothing herein contained shall be taken to release the estate of a deceased joint holder from any liability on shares held by him jointly with any other persons.	<b>DEATH OF ONE OR MORE JOINT-HOLDERS OF SHARES</b>
37.	The executors or administrators or holders of a Succession Certificate or the legal representatives of a deceased member (not being one or two or more joint-holders) shall be the only persons recognized by the Company as having any title to the share registered in the name of such member and the Company shall not be bound to recognize such executors or administrators or holder or a Succession Certificate or the legal representatives unless they have first obtained Probate or Letters of Administration or Succession Certificate, as the case may be from a duly constituted Court in the Union of India, provided that in any case where the Board in its absolute discretion, thinks fit, it may dispense with production of Probate or Letters of Administration or Succession Certificate upon such terms as to indemnify or otherwise as the Board in its absolute discretion may think necessary and under Article 36, register the name of any person who claims to be absolutely entitled to the shares standing in the name of a deceased member as a member.	<b>TITLE OF SHARES OF DECEASED MEMBER</b>
38.	No share shall in any circumstance be subscribed for transfer to any infant, minor, insolvent or person of unsound mind.	<b>NO TRANSFER TO MINOR ETC.</b>
39.	Subject to the provisions of the Act and Articles 34 and 35 any person becoming entitled to shares in consequence of the death, lunacy, bankruptcy or insolvency of any member, or by any lawful means other than by a transfer in accordance with these Articles may, with the consent of the Board (which it shall not be under any obligation to give), upon producing such evidence that he sustains the character in respect of which he proposes to act under this Article or of such title as the Board thinks sufficient, either be registered himself as the holder of the shares or elect to have some persons nominated by him and approved by the Board registered as such holder; provided nevertheless, that if such person shall elect to have his nominee registered he shall testify the election by executing in favour of his nominee an instrument of transfer in accordance with the provision herein contained, and until he does so, he shall not be freed from any liability in respect of the shares.	<b>REGISTRATION OF PERSONS ENTITLED TO SHARES OTHERWISE THAN BY TRANSFER</b>
40.	A person entitled to a share by transmission shall, subject to the right of the Directors to retain such dividends of money as hereinafter provided, be entitled to receive any and may give discharge for any dividends or other moneys payable in respect of the share.	<b>PERSONS ENTITLED MAY RECEIVE DIVIDEND WITHOUT BEING REGISTERED AS MEMBER</b>
41.	<p>a) No fee shall be charged for :</p> <p>i) Registration of transfer of the Company's shares and debentures;</p> <p>ii) sub-division and consolidation of shares and debenture certificates and for subdivision of letters of allotment and split, consolidation, renewal and pucca transfer receipts into denominations corresponding to the market units of trading;</p> <p>iii) Sub-division of renounceable letters of right;</p> <p>iv) Issue of new certificates in replacement of those which are old, decrepit or worn out or where the cages on the reverse for recording transfer have been fully utilized;</p> <p>v) Registration of any power of attorney, probate, letters of administration or similar other documents.</p> <p>b) Fees as agreed upon with the Stock Exchanges will be charged for</p> <p>i) Issue of new certificates in replacement of those that are torn, defaced, lost or destroyed;</p>	<b>FEE ON REGISTRATION OF TRANSFER, PROBATE, ETC</b>



ii) Sub-division and consolidation of shares and debenture certificates and for subdivision of letters of allotment and split, consolidation, renewal and pucca transfer receipts into denominations other than those fixed for the market unit of trading

42. The company shall incur no liability or responsibility whatsoever in consequence of its registering or giving effect to any transfer of shares made or purporting to be made by any apparent legal owner thereof (as shown or appearing in the Register of Members) to the prejudice of persons having or claiming equitable right, title or interest to or in the said shares, notwithstanding that the Company may have had notice of such equitable right, title or interest or notice prohibiting registration of such transfer and may have entered such notice referred thereto, in any book of the Company and the Company shall not be bound or required to regard or attend or give effect to any notice which may be given to it of any equitable right, title or interest or to be under any liability whatsoever for refusing or neglecting so to do though it may have been entered or referred to in some book of the Company, but the Company shall nevertheless be at liberty to regard and attend to any such notice and give effect thereto if the Board shall so think fit.

**COMPANY NOT  
LIABLE FOR  
DISREGARD OF A  
NOTICE  
PROHIBITING  
REGISTRATION OF A  
TRANSFER**

43. The Board may, from time to time, raise any money or any moneys or sums of money for the purpose of the Company; provided that the moneys to be borrowed together with the moneys already borrowed by the Company (apart from temporary loans obtained from the Company's bankers in the ordinary course of business) shall not, without the sanction of the Company at a General Meeting, exceed the aggregate of the paid-up capital of the Company and its free reserves, that is to say, reserves not set-apart for any specific purpose and in particular but subject to the provisions of Section 179 of the Act, the Board may, from time to time, at its discretion raise or borrow or secure the payment of any such sum or sums of money for the purpose of the Company, by the issue of debentures to members, perpetual or otherwise including debentures convertible into shares of this or any other company or perpetual annuities in security of any such money so borrowed, raised or received, mortgage, pledge or charge, the whole or any part of the property, assets, or revenue of the Company, present or future, including its uncalled capital by special assignment or otherwise or transfer or convey the same absolutely or entrust and give the lenders powers of sale and other powers as may be expedient and purchase, redeem or pay off any such security. Provided that every resolution passed by the Company in General Meeting in relation to the exercise of the power to borrow as stated above shall specify the total amount upto which moneys may be borrowed by the Board of Directors, provided that subject to the provisions of clause next above, the Board may, from time to time, at its discretion, raise or borrow or secure the repayment of any sum or sums of money for the purpose of the Company as such time and in such manner and upon such terms and conditions in all respects as it thinks fit and in particular, by promissory notes or by opening current accounts, or by receiving deposits and advances, with or without security or by the issue of bonds, perpetual or redeemable debentures or debenture stock of the Company charged upon all or any part of the property of the Company (both present and future) including its uncalled capital for the time being or by mortgaging or charging or pledging any land, building, bond or other property and security of the Company or by such other means as them may seem expedient.

**BORROWING  
POWERS POWER TO  
BORROW**

44. Any bonds, debentures, debenture-stock or other securities may be issued at a discount, premium or otherwise and may be issued on condition that they shall be convertible into shares of any denomination, and with any privileges and conditions as to redemption, surrender, drawing, allotment of shares and attending (but not voting) at general meetings, appointment of Directors and otherwise. Bonds or debentures with the right to conversion into or allotment of shares shall be issued only with the consent of the Company in General Meeting accorded by a Special Resolution.

**TERMS OF ISSUE OF  
BONDS, DEBENTURES**

45. The Board shall cause a proper Register to be kept in accordance with the provisions of Section 85 of the Act of all mortgages, debentures and charges specifically affecting the property of the Company, and shall cause the requirements of, Sections 77 to 85 of the Act in that behalf to be duly complied with so far as they fall to be complied with by the Board.	<b>REGISTER OF MORTGAGES, ETC. TO BE KEPT</b>
46. The Company shall, if at any time issues debentures, keep a Register and Index of debenture- holders in accordance with Section 88 of the Act and the details of the members holding debentures both in material and dematerialized form in any media as permitted by law including electronic media. The Company shall also be entitled to keep in any state or country outside India a Branch Register of debenture-holders resident in that state or country.	<b>REGISTER AND INDEX OF DEBENTURE HOLDER</b>
47. The Company shall in each year hold a General Meeting as its Annual General Meeting in addition to any other meetings in that year. All General Meetings other than Annual General Meetings shall be called Extraordinary General Meetings. The first Annual General Meeting shall be held within eighteen months from the date of incorporation of the Company and the next Annual General Meeting shall be held within six months after the expiry of the financial year, provided that not more than fifteen months shall lapse between the date of one Annual General Meeting and that of the next. Nothing contained in the foregoing provisions shall be taken as affecting the right conferred upon the Registrar under the provisions of 96 of the Act to extend the time within which any Annual General Meeting may be held.	<b>MEETINGS OF MEMBERS ANNUAL GENERAL MEETING</b>
48. The Board may, whenever it thinks fit, call an Extraordinary General Meeting and it shall do so upon a requisition in writing by any member or members holding in the aggregate not less than one-tenth of such of the paid-up capital as at that date arrives the right of the voting in regard to the matter in respect of which the requisition has been made	<b>EXTRAORDINARY GENERAL MEETING</b>
49. Any valid requisition so made by members must state the object or objects of the meeting proposed to be called, and must be signed by the requisitionists and be deposited at the office provided that such requisition may consist of several documents in like form each signed by one or more requisitionists.	<b>REQUISITION OF MEMBERS TO STATE OBJECT OF MEETING</b>
50. Upon receipt of any such requisition, the Board shall forthwith call an extraordinary General Meeting and if they do not proceed within twenty one days from the date of the requisition being deposited at the office cause a meeting to be called on a day not later than forty-five days from the date of deposit of the requisition, the requisitionists, or such of their number as represent either a majority in value of the paid-up share capital held by all of them or not less than one-tenth of such of the paid-up share capital of the Company as is referred to in 100 of the Act, whichever is less, may themselves call the meeting, but in either case any meeting so called shall be held within three months from the date of the delivery of the requisition as aforesaid.	<b>ON RECEIPT OF REQUISITION, DIRECTORS TO CALL MEETING, IN DEFAULT REQUISITIONISTS MAY DO SO</b>
51. Any meeting called under the foregoing Articles by the requisitionists shall be called in the same manner, as nearly as possible, as that in which meetings are to be called by the Board.	<b>MEETING CALLED BY REQUISITIONISTS</b>
52. a. Twenty-one days' notice at least of every General Meeting, Annual, Extraordinary, and by whomsoever called specifying the day, date, place and hour of meeting, and the general nature of the business to be transacted there at, shall be given in the manner hereinafter provided, to such persons as are under these Articles entitled to receive notice from the Company. Provided that a general meeting may be called after giving a shorter notice if consent is given in writing or by electronic mode by not less than ninety-five per cent of the members entitled to vote at such meeting.	<b>LENGTH OF NOTICE AND NATURE OF BUSINESS</b>
b. All business shall be deemed special that is transacted at an Extraordinary Meeting and also that is transacted at an Annual Meeting with the exception of declaration of a dividend, the consideration of financial statements and the reports of the Directors and Auditors thereon, the election of the Directors in the place of those retiring, and	

	<p>the appointment of and the fixing of the remuneration of Auditors. Where any item of business to be transacted at the meeting is deemed to be special as aforesaid, there shall be annexed to the notice of the meeting a statement setting out all material facts concerning each such item of business including in particular the nature of the concern or interest, if any, therein, of every Director and the Manager, if any, every other Key Managerial Personnel and the relatives of Directors, Manager and other Key Managerial Personnel. Where any item of business consists of the according of approval to any document by the meeting, the time and place where the document can be inspected shall be specified in the statement aforesaid.</p> <p>c. Where any item of special business to be transacted at a meeting of the company relates to or affects any other company, the extent of shareholding interest in that other company of every promoter, director, manager, if any, and of every other key managerial personnel of the first mentioned company shall, if the extent of such shareholding is not less than two per cent of the paid-up share capital of that company, also be set out in the statement.</p>	
53.	The accidental omission to give any such notice as aforesaid to any of the members, or the non-receipt thereof, shall not invalidate any resolution passed at any such meeting.	<b>OMISSION TO GIVE NOTICES NOT TO INVALIDATE A RESOLUTION PASSED</b>
54.	No General Meeting, Annual or Extraordinary shall be competent to enter upon, discuss or transact any business which has not been mentioned in the notice or notices upon which it was convened.	<b>MEETING NOT TO TRANSACT BUSINESS NOT MENTIONED IN NOTICE</b>
55.	<p>The quorum requirements for general meetings shall be as under and no business shall be transacted at any General Meeting unless the requisite quorum is present when the meeting proceeds to business:</p> <p>Number of member's up to 1000: 5 members personally present            Number of members 1000-5000: 15 members personally present            Number of members more than 5000: 30 members personally present</p>	<b>QUORUM AT GENERAL MEETING</b>
56.	A body corporate being a member shall be deemed to be personally present if it is represented in accordance with Section 113 of the Act.	<b>BODY CORPORATE DEEMED TO BE PERSONALLY PRESENT</b>
57.	<p>If the quorum is not present within half-an-hour from the time appointed for holding a meeting of the company—</p> <p>(a) the meeting shall stand adjourned to the same day in the next week at the same time and place, or to such other date and such other time and place as the Board may determine; or</p> <p>(b) the meeting, if called by requisitionists under section 100, shall stand cancelled If at the adjourned meeting also, a quorum is not present within half-an-hour from the time appointed for holding meeting, the members present shall be the quorum. In case of an adjourned meeting or of a change of day, time or place of meeting under clause (a), the company shall give not less than three days notice to the members either individually or by publishing an advertisement in the newspapers (one in English and one in vernacular language) which is in circulation at the place where the registered office of the company is situated.</p>	<b>IF QUORUM NOT PRESENT, MEETING TO BE DISSOLVED OR ADJOURNED</b>
58.	The Chairman of the Board of Directors shall be entitled to take the chair at every General Meeting, whether Annual or Extraordinary. If at any meeting he shall not be present within fifteen minutes of the time appointed for holding such meeting or if he shall be unable or unwilling to take the chair, then the Vice-Chairman of the Board of Directors shall be entitled to take the chair, at such General Meeting. If at any meeting the Vice- Chairman shall not be present within fifteen minutes of the time	<b>CHAIRMAN OF GENERAL MEETING</b>

	appointed for holding such meeting or if he shall be unable or unwilling to take the chair, then the Directors present shall elect any Director present and willing to take the chair as Chairman, and if no Director be present or if all the Directors present decline to take the chair, then the members present shall elect one of their member to be the Chairman of such meeting.	
59.	No business shall be discussed at any General Meeting except the election of a Chairman whilst the chair is vacant	<b>BUSINESS CONFINED TO THE ELECTION OF CHAIRMAN WHILST CHAIR VACANT</b>
60.	The Chairman with the consent of the members may adjourn any meeting from time to time and from place to place in the city or town in which the office of the company is for the time being situate but no business shall be transacted at any adjourned meeting other than the business left unfinished at the meeting from which the adjournment took place.	<b>CHAIRMAN WITH CONSENT MAY ADJOURN MEETING</b>
61.	At any General Meeting, a resolution put to the vote of the meeting shall be decided on a show of hands/result of electronic voting as per the provisions of Section 108, unless a poll is (before or on declaration of the result of the show of hands/e-voting) demanded in accordance with the provisions of Section 109. Unless a poll is so demanded, a declaration by the Chairman that a resolution has, on a show of hands/electronic voting, been carried unanimously or by a particular majority or lost and an entry to that effect in the book of the proceedings of the Company shall be conclusive evidence of the fact without proof of the number or proportion of the votes recorded in favour of or against that resolution.	<b>QUESTIONS AT GENERAL MEETING HOW DECIDED</b>
62.	In the case of an equality of votes, the Chairman shall, both on a show of hands or electronically and at poll (if any), have a casting vote in addition to the vote or votes to which he may be entitled as a member.	<b>CHAIRMAN'S CASTING VOTE</b>
63.	If a poll is duly demanded in accordance with the provisions of Section 109, it shall be taken in such manner as the Chairman, subject to the provisions of Section 109 of the Act, may direct, and the results of the poll shall be deemed to be the decision of the meeting on the resolution on which the poll was taken.	<b>POLL TO BE TAKEN IF DEMANDED</b>
64.	Any poll duly demanded on the election of a Chairman of a meeting or any question of adjournment shall be taken at the meeting forthwith	<b>IN WHAT CASE POLL BE TAKEN WITHOUT ADJOURNMENT</b>
65.	The demand for a poll except on the question of the election of the Chairman and of an adjournment shall not prevent the continuance of a meeting for the transaction of any business other than the question on which the poll has been demanded.	<b>DEMAND FOR POLL NOT TO PREVENT TRANSACTION OF OTHER BUSINESS</b>
66.	a. The Company shall comply with the requirements of Section 118 of the Act, in respect of the keeping of the minutes of all proceedings of every General Meeting and every meeting of the Board or any Committee of the Board.  b. The Chairman of the meeting shall exclude at his absolute discretion such of the matters as are or could reasonably be regarded as defamatory of any person irrelevant or immaterial to the proceedings or detrimental to the interests of the Company.  c) The book containing the minutes of proceedings of General Meetings shall be kept at the office of the Company and shall be open during business hours, for such period not being less in the aggregate than two hours in each days as the Directors determine to inspection of any member without charge.	<b>MINUTES OF MEETINGS</b>  <b>MINUTES OF GENERAL MEETING AND INSPECTION THEREOF BY MEMBERS</b>
67.	Subject to the provisions of the Companies Act, 2013, the number of Directors shall not be less than three and not more than fifteen	<b>DIRECTORS</b>  <b>NUMBER OF DIRECTORS</b>

68. The following persons are the first Directors of Company:

- 1) ROOP LAL PATEL
- 2) GEETA PALIWAL
- 3) DILIP KUMAR GADIA

**FIRST DIRECTORS**

69. Subject to the provisions of Section 152 of the Act, not less than two-thirds of total number of Directors of the Company shall:

a) be persons whose period of office is liable to determination by retirement of Directors by rotation; and

b) save as otherwise expressly provided in the Act, be appointed by the Company in General Meeting.

**DIRECTORS OF THE COMPANY**

70. . Notwithstanding anything to the contrary contained in these Articles, so long as any moneys remain owing by the Company to the Banks or a State Finance Corporation or any Financial Institution owned or controlled by the Central Government or a State Government or the Reserve Bank of India or by two or more of them or by Central Government or State Government by themselves or by any agency nominated by the central government (each of the above is hereinafter this Article referred to as “the Corporation”) out of any loan/debenture assistance granted by them to the Company or so long as the Corporation holds or continues to hold Debentures/ Shares in the Company as a result of underwriting or by direct subscription or private placement, or so long as any liability of the Company arising out of any guarantee furnished by the Corporation on behalf of the Company remains outstanding, the Corporation shall have a right to appoint from time to time, any person or persons as a Director or Directors whole time or non whole-time (which Director or Directors, is/are hereinafter referred to as Nominee Directors) on the board of the Company and to remove from such office any person or persons so appointed and to appoint any person in his or their place/s. The Nominee Director/s appointed under this Article shall be entitled to receive all notices of and attend all General Meetings, Board Meetings and of the Meetings of Committee of which the Nominee Director/s is/are member/s as also the minutes of such meetings. The corporation shall also be entitled to receive all such notices and minutes. The Board of Directors of the company shall have no power to remove from office the Nominee Director/s. Subject as aforesaid; the Nominee Director/s shall be entitled to the same rights privileges and subject to the same obligations as any other Director of the Company. The Nominee Director/s so appointed shall hold the said office only so long as any moneys remain owing by the Company to the Corporation or so long as the Corporation holds or continues to hold Debentures/Shares in the Company as a result of underwriting or by direct subscription or private placement or the liability of the Company arising out of the guarantee is outstanding and the Nominee Directors so appointed in exercise of the said power shall ipso facto vacate such office immediately the moneys owing by the Company to Corporation or on the satisfaction of the liability of the Company arising out of the guarantee furnished by the Corporation. The company shall pay to the Nominee Director/s sitting fees and expenses to which the other Directors of the Company are entitled, but if any other fees, commission, monies or remuneration in any form is payable to the Director/s of the Company, the fees, commission monies and remuneration in the relation to such Nominee Director/s shall accrue to the Corporation and the same shall accordingly be paid by the company directly to Corporation. Any expenses that may be incurred by the Corporation or such Nominee Director/s in connection with their appointment or Directorship shall also be paid or reimbursed by the Company to the Corporation or as the case may be, to such Nominee Director/s. Provided that if any such Nominee Director/s is an officer of the Corporation, the sitting fees in relation to such Nominee Director/s shall also accrue to the corporation and the same shall accordingly be paid by the Company directly to the Corporation. Provided also that in the event of the Nominee Director/s being appointed as whole time Director/s, such Nominee Director/s shall exercise such

**APPOINTMENT OF NOMINEE DIRECTORS**

	power and duties as may be approved by the Corporation and have such rights as are exercised or available to whole time director in the management of the affairs of the Company. Such whole-time Director(s) shall be entitled to receive such remuneration, fee, commission, and monies as may be approved by the Corporation.	
71.	Whenever the Directors enter into a contract with any Government, Central, State or local authority, Institution or any person or persons for borrowing any money or for providing any guarantee of security or for technical collaboration of assistance or for underwriting or enter into any other arrangement whatsoever, the Directors shall have subject to the provisions of the Act, the power to agree that such government authority, institution, person or persons shall have the right to appoint or nominate by a notice in writing addressed to the Company one or more Directors on the Board for such period and upon such conditions as may be mentioned in the agreement and that such Director or Directors may also agree that any such Director or Directors may be removed from time to time by the Government, institution, person or persons entitled to appoint or nominate them and such person or persons may appoint another or others in his or their place and also fill in any vacancy, which occurs as a result of any such Director or Directors ceasing to hold that office for any reason whatever. The Directors appointed or nominated under this Article shall be entitled to exercise and enjoy all or any of the rights and privileges exercised and enjoyed by the Directors of the Company including the payment of remuneration and travelling expenses to such Director or Directors as may be agreed by the Company with such person or persons aforesaid.	<b>POWER TO APPOINT EX-OFFICIO DIRECTORS</b>
72.	If it is provided by the Trust Deed securing or otherwise, in connection with any issue of debenture of the Company that any person or persons shall have power to nominate a Director of the Company, then in the case of any and every such issue of debenture, the person or persons having such power may exercise such power from time to time and appoint a Director accordingly. Any Director so appointed is herein referred to as Debenture Director. A Debenture Director may be removed from office at any time by the person or persons in whom for the time being is vested the power under which he was appointed and another Director may be appointed in his place. A Debenture Director shall not be liable to retire by rotation.	<b>DEBENTURE DIRECTORS</b>
73.	The Board may, in accordance with and subject to the provision of Section 161 of the Act, appoint an Alternate Director to act for a Director during latter's absence for a period of not less than three months from India. An Alternate Director appointed under this Article shall not hold office for a period longer than that permissible to the original Director in whose place he has been appointed and shall vacate office, if and when the original Director returns, to India. If the term of office of the original Director is determined before he so returns, any provisions in the Act or in these Articles for the automatic reappointment of a retiring Director in default of another appointment shall apply to the original Director and not the alternate Director.	<b>APPOINTMENT OF ALTERNATE DIRECTOR</b>
74.	Subject to the provisions of 161 of the Act the Board shall have power at any time and from time to time to appoint any other person to be an Additional Director but so that the total number of Directors shall not at any time exceed the maximum fixed under Article 67. Any such Additional Director shall hold office only up to the date of the next Annual General Meeting.	<b>DIRECTOR'S POWER TO ADD TO THE BOARD</b>
75.	The Board of Directors may appoint such number of Independent Directors as are required under Section 149 of the Companies Act, 2013 or Clause 49 of Listing Agreement, whichever is higher, from time to time) Independent directors shall possess such qualification as required under Section 149 of the Companies Act, 2013 and Clause 49 of Listing Agreement. Independent Director shall be appointed for such period as prescribed under relevant provisions of the Companies Act, 2013 and Listing Agreement and shall not be liable to retire by rotation.	<b>INDEPENDENT DIRECTORS</b>
76.	The Board of Directors shall appoint one women director as per the requirements of Section 149 of the Act.	<b>WOMEN DIRECTOR</b>

77.	Subject of the provisions of the Act, the Board shall have power at any time to appoint any other person to be a Director to fill a casual vacancy. Any person so appointed shall hold office only upto the date up to which the Director in whose place he is appointed would have held office if it had not been vacated by him.	<b>DIRECTOR'S POWER TO FILL CASUAL VACANCIES</b>
78.	<p>a. Subject to the provisions of the Act, a chief executive officer, manager, company secretary or chief financial officer may be appointed by the Board for such term, at such remuneration and upon such conditions as it may think fit; and any chief executive officer, manager, company secretary or chief financial officer so appointed may be removed by means of a resolution of the Board.</p> <p>b. A director may be appointed as chief executive officer, manager, company secretary or chief financial officer subject to provisions of the Act.</p> <p>c. The Managing Director shall act as the Chairperson of the Company for all purposes subject to the provisions contained in the Act and these articles.</p>	<b>KEY MANAGERIAL PERSONNEL</b>
79.	<p>a. Until otherwise determined by the Company in General Meeting, each Director shall be entitled to receive and be paid out of the funds of the Company a fee for each meeting of the Board of Directors or any committee thereof, attended by him as may be fixed by the Board of Directors from time to time subject to the provisions of Section 197 of the Act, and the Rules made there under. For the purpose of any resolution in this regard, none of the Directors shall be deemed to be interested in the subject matter of the resolution. The Directors shall also be entitled to be paid their reasonable travelling and hotel and other expenses incurred in consequence of their attendance at meetings of the Board or of any committee of the Board or otherwise in the execution of their duties as Directors either in India or elsewhere. The Managing/Whole-time Director of the Company who is a full time employee, drawing remuneration will not be paid any fee for attending Board Meetings.</p> <p>b. Subject to the provisions of the Act, the Directors may, with the sanction of a Special Resolution passed in the General Meeting and such sanction, if any, of the Government of India as may be required under the Companies Act, sanction and pay to any or all the Directors such remuneration for their services as Directors or otherwise and for such period and on such terms as they may deem fit.</p> <p>c. Subject to the provisions of the Act, the Company in General Meeting may by special Resolution sanction and pay to the Director in addition to the said fees set out in sub-clause (a) above, a remuneration not exceeding one per cent (1%) of the net profits of the Company calculated in accordance with the provisions of Section 198 of the Act. The said amount of remuneration so calculated shall be divided equally between all the Directors of the Company who held office as Directors at any time during the year of account in respect of which such remuneration is paid or during any portion of such year irrespective of the length of the period for which they held office respectively as such Directors.</p> <p>d. Subject to the provisions of the Companies Act, and subject to such sanction of the Government of India, as may be required under the Companies Act, if any Director shall be appointed to advise the Directors as an expert or be called upon to perform extra services or make special exertions for any of the purposes of the Company, the Directors may pay to such Director such special remuneration as they think fit; such remuneration may be in the form of either salary, commission, or lump sum and may either be in addition to or in substitution of the remuneration specified in clause (a) of the Article.</p>	<b>REMUNERATION OF DIRECTORS</b>
80.	The continuing Director may act notwithstanding any vacancy in their body but if and so long as their number is reduced below the minimum, the continuing Directors not being less than two may act for the purpose of increasing the number of Directors to	<b>DIRECTOR MAY ACT NOTWITHSTANDING ANY VACANCY</b>

	that number, or of summoning a General Meeting, but for no other purpose.	
81.	<p>The office of a Director shall be vacated if:</p> <ol style="list-style-type: none"> <li>1. He is found to be unsound mind by a Court of competent jurisdiction;</li> <li>2. He applies to be adjudicated as an insolvent;</li> <li>3. He is an undercharged insolvent;</li> <li>4. he is convicted by a Court of any offence whether involving moral turpitude or otherwise and is sentenced in respect thereof to imprisonment for not less than six months and a period of five years has not elapsed from the date of expiry of the sentence;</li> <li>5. He fails to pay any call in respect of shares of the Company held by him, whether alone or jointly with others, within six months from the last date fixed for the Payment of the call;</li> <li>6. An order disqualifying him for appointment as Director has been passed by court or tribunal and the order is in force.</li> <li>7. He has not complied with Subsection (3) of Section 152</li> <li>8. He has been convicted of the offence dealing with related party transaction under section 188 at any time during the preceding five years.</li> <li>9. He absents himself from all meetings of the Board for a continuous period of twelve months, with or without seeking leave of absence from the Board;</li> <li>10. he acts in contravention of Section 184 of the Act and fails to disclose his interest in a contract in contravention of section 184.</li> <li>11. He becomes disqualified by an order of a court or the Tribunal</li> <li>12. He is removed in pursuance of the provisions of the Act,</li> <li>13. Having been appointed a Director by virtue of holding any office or other employment in the company, he ceases to hold such office or other employment in the Company; notwithstanding anything in Clause (4), (6) and (8) aforesaid, the disqualification referred to in those clauses shall not take effect: <ol style="list-style-type: none"> <li>1. for thirty days from the date of the adjudication, sentence or order;</li> <li>2. where any appeal or petition is preferred within the thirty days aforesaid against the adjudication, sentence or conviction resulting in the sentence or order until the expiry of seven days from the date on which such appeal or petition is disposed off; or</li> <li>3. Where within the seven days as aforesaid, any further appeal or petition is preferred in respect of the adjudication, sentence, conviction or order, and appeal or petition, if allowed, would result in the removal of the disqualification, until such further appeal or petition is disposed off.</li> </ol> </li> </ol>	<b>WHEN OFFICE OF DIRECTORS TO BECOME VACANT</b>
82.	Subject to the provisions of Section 188 of the Act and other limitations, if any, prescribed in the Companies Act, 2013, the Directors shall be entitled to contract with the Company and no Director shall be disqualified by having contracted with the Company as aforesaid.	<b>DIRECTOR MAY CONTRACT WITH COMPANY</b>
83.	A Director of the Company who is in any way, whether directly or indirectly concerned or interested in a contract or arrangement, or proposed contract or arrangement entered into or to be entered into by or on behalf of the Company shall disclose the nature of his concern or interest at a meeting of the Board in the manner provided in 184 of the Act. Provided that it shall not be necessary for a director to disclose his concern or interest in any contract or arrangement entered into or to be entered into with any other company where any of the directors of the Company or two or more of them together holds or hold not more than two percent of the paid-up share capital in any such other company.	<b>DISCLOSURE OF INTEREST</b>
84.	A general notice given to the Board by the directors to the effect that he is a director or member of a specified body corporate or is a member of a specified firm and is to be regarded as concerned or interested in any notice shall expire at the end of the financial year in which it shall be given but may be renewed for a further period of one financial year at a time by a fresh notice given in the last month of the financial year in which it would have otherwise expired. No such general notice, and no renewal thereof shall be of effect unless, either it is given at a meeting of the Board or director concerned takes reasonable steps to secure that it is brought up and read at	<b>GENERAL NOTICE OF DISCLOSURE OF INTEREST</b>



	the first meeting of the Board after it is given.	
85.	At every Annual General Meeting of the Company, one third of such of the Directors, for the time being as are liable to retire by rotation or, if their number is not three or a multiple of three, the number nearest to one-third shall retire from office. In the following Articles 'a Retiring Director' means a Director retiring by rotation. The Company shall comply with the provisions of Section 152 in this regard.	<b>RETIREMENTS AND ROTATION OF DIRECTORS</b>
86.	<p>a) If the place of the retiring Director is not so filled up and the meeting had not expressly resolved not to fill the vacancy, the meeting shall stand adjourned till the same day in the next week, at the same time and place, or if that day is a national holiday, till the next succeeding day which is not a holiday, at the same time and place.</p> <p>b) If at the adjourned meeting also it has been not expressly resolved not to fill the vacancy the retiring Director shall be deemed to have been reappointed at the adjourned meeting, unless,</p> <p>i. at that meeting or at the previous meeting resolution for the reappointment of such Director has been put to the meeting and lost;</p> <p>ii. The retiring Director has, by a notice in writing addressed to the Company or its Board, expressed his unwillingness to be so reappointed;</p> <p>iii. He is not qualified or is disqualified for appointment;</p> <p>iv. A resolution, whether special or ordinary, is required for the appointment or re-appointment by virtue of any provisions of the Act; or</p> <p>v. the provision to 162 of the Act is applicable to the case.</p>	<b>PROVISION IN DEFAULT OF APPOINTMENT</b>
87.	Subject to of the Act, the Company may, by ordinary resolution, from time to time, increase or reduce the number of Directors, and may alter their qualifications and the Company may (subject to the provision of Section 169 of the Act) remove any Director before the expiration of his period of office and appoint another person instead. The person so appointed shall hold office during such time as Director in whose place he is appointed would have held the same if he had not been removed.	<b>COMPANY MAY INCREASE OR REDUCE THE NUMBER OF DIRECTORS</b>
88.	<p>a) No person not being a retiring Director shall be eligible for appointment to the office of Director at any General Meeting unless he or some member intending to propose him has, not less than fourteen days before the meeting, left at the office of the Company a notice in writing under his hand signifying his candidature for the office of Director or the intention of such member to propose him as a candidate for that office along with deposit of such sum as may be prescribed by the Act or the Central Government from time to time which shall be refunded to such person or as the case may be, to such member, if the person succeeds in getting elected as a Director gets more than 25% of total valid votes cast either on show of hands or on poll on such resolution.</p> <p>b) Every person other than a Director or a person who has left at the office of the Company a notice under 160 of the Act signifying his candidature for the office of a Director posted as a candidate for the office of a Director shall sign and file with the Company, the consent in writing to act as a Director, if appointed.</p> <p>c) A person other than a Director re-appointed after retirement by rotation or immediately on the expiry of his term of office, or an Additional or Alternate Director, or a person filling a casual vacancy in the office of Director under the Act immediately on the expiry of his term of office, shall not act as a Director of the Company, unless he has within thirty days of his appointment signed and filed with the Registrar his consent in writing to act as such Director.</p>	<b>NOTICE OF CANDIDATE FOR OFFICE OF DIRECTOR EXCEPT IN CERTAIN CASES</b>
89.	a) The company shall keep at its office a Register containing the particulars of its Directors, Manager, Secretary and other persons mentioned in Section 170 of the Act and shall otherwise comply with the provisions of the said Section in all respect.	<b>REGISTER OF DIRECTORS ETC., AND NOTIFICATION OF CHANGE TO</b>

	<b>REGISTRAR</b>
90. Every Director including a person deemed to be a Director by virtue of the Explanation to 170 of the Act, Manager, or Secretary of the Company shall within twenty days of his appointment to any of the above office in any other body corporate, disclose to the Company the particulars relating to his office in the other body corporate which are required to be specified under Section 170 of the Act.	<b>DISCLOSURE BY DIRECTOR OF APPOINTMENT TO ANY OTHER BODY CORPORATE</b>
91. The Company shall not appoint any person as its Director if: <ul style="list-style-type: none"> <li>a) He has been found to be of unsound mind by a Court of competent jurisdiction and the findings is in force;</li> <li>b) He is an undischarged insolvent;</li> <li>c) He has applied to be adjudicated as an insolvent and his application is pending;</li> <li>d) He has been convicted by a Court of any offence whether involving moral turpitude or otherwise and sentenced in respect thereof to imprisonment for not Less than six months, and a period of five years has not elapsed from the date of expiry of the sentence;</li> <li>e) he has not paid any call in respect of shares of the Company held by him, whether alone or jointly with others, and six months have elapsed from the last day fixed for the payment of the call; or</li> <li>f) An order disqualifying him for appointment as Director has been passed by a Court and it is in force</li> <li>g) He has been convicted of the offence dealing with related party transactions under section 188 at any time during the last preceding five years</li> <li>h) he has not complied with sub-section (3) of section 152 No person who is or has been a director of a company which— <ul style="list-style-type: none"> <li>(a) Has not filed financial statements or annual returns for any continuous period of three financial years;</li> <li>or</li> <li>(b) has failed to repay the deposits accepted by it or pay interest thereon or to redeem any debentures on the due date or pay interest due thereon or pay any dividend declared and such failure to pay or redeem continues for one year or more, shall be eligible to be re-appointed as a director of that company or appointed in other company for a period of five years from the date on which the said company fails to do so.</li> </ul> </li> </ul>	<b>DISQUALIFICATION OF DIRECTORS</b>
92. Subject to the provisions of the Act and of these Articles, the Board shall have the power to appoint from time to time any of its members as Managing Director or Managing Directors of the Company for a fixed term not exceeding five years at a time and upon such terms and conditions as the Board thinks fit, and subject to the provisions of the act, the Board may by resolution vest in such Managing Director or Managing Directors such of the powers hereby vested in the Board generally as it thinks fit and such powers may be made exercisable for such period or periods and upon such conditions and subject to such restrictions as it may determine. The remuneration of a Managing Director may be by way of monthly payment, fee for such meeting or participation in profits or by any or all of these modes or any other mode not expressly prohibited by the Act.	<b>MANAGING DIRECTOR</b> <b>THE BOARD MAY APPOINT MANAGING DIRECTOR</b>
93. A Managing Director shall not while he continues to hold that office be subject to retirement by rotation in accordance with Article 85 if he ceases to hold the office of Director he shall ipso facto and immediately cease to be a Managing Director	<b>SPECIAL POSITION OF MANAGING DIRECTOR</b>
94. a) The Directors may meet together as a Board for dispatch of business from time to time, and shall so meet at least once in every three months and at least four such meetings shall be held in every year with a maximum time gap of 120 days between two meetings. The Directors may adjourn and other wise regulate their meetings as they think fit.	<b>PROCEEDINGS OF THE BOARD OF DIRECTORS MEETING OF DIRECTORS</b>
b) Subject to the provisions of Section 173, the Board and/or the Committees of the	

	Board may, if the circumstances warrant, meet and/or discuss, resolve by means of telephone, fax, electronic mail, television or through any other audio-visual links known as audio and/or video conferencing instead of physical meetings.	
95.	At least seven days notice of every meeting of the Board shall be given in writing to every Director for the time being in India and at his usual address in India to every other Director provided however that in the case of a Director resident outside India, notice of every meeting of the Board shall also be given to such Director at his address outside India and to his alternate, if any, in India at his usual address in India. Such notice shall be accompanied by the agenda setting out the business proposed to be transacted at the meeting of the Board. Provided that a meeting of the Board may be convened in accordance with Article 52 by a shorter notice in the case of an emergency or if special circumstances so warrant, subject to compliance with provisions of the Act.	<b>NOTICE OF MEETINGS</b>
96.	Subject to provisions of the Act, the quorum for a meeting of the Board shall be one third of its total strength (excluding Directors, if any, whose place may be vacant at the time and any fraction contained in that one-third being rounded of as one) or two Directors, whichever is higher, provided, that where at any time the number of interested Director exceeds or is equal to two-thirds of the total strength in number of the remaining Directors, that is to say, the number of Directors who are not interested, present at the meeting being not less than two, shall be the quorum during such time.	<b>QUORUM</b>
97.	If a meeting of the Board could not be held for want of quorum then the meeting shall automatically stand adjourned to such other date and time (if any) as may be fixed by the Chairman not being later than seven days from the date originally fixed for the meeting.	<b>ADJOURNMENT OF MEETING FOR WANT OF QUORUM</b>
98.	The Secretary shall, as and when directed by the Chairman or Vice Chairman or by a Director or Directors to do so, convene a meeting of the Board by giving a notice in writing to every Director.	<b>WHEN MEETING TO BE CONVENED</b>
99.	a) The Board may appoint from amongst its members a Chairman, and a Vice Chairman.  b) The Chairman of the Board shall be entitled to take the chair at every meeting of the Board. If at any meeting of the Board the Chairman shall not be present within fifteen minutes of the time appointed for holding the same or if he be unable or unwilling to take the chair then the Vice Chairman shall be entitled to take the chair at such Board Meeting.,	<b>CHAIRMAN AND VICE CHAIRMAN</b>
100.	A meeting of the Board for the time being in which a quorum is present shall be competent to exercise all or any of the authorities, powers and discretion which by or under the Act or the Articles of the Company are for the time being vested in or exercisable by the Board generally.	<b>POWERS OF THE BOARD MEETING</b>
101.	Subject to the provisions of the Act and the restrictions contained in Section 179 of the Act, the Board may delegate any of their powers to committees of the Board consisting of such members or of its body as it thinks fit, and it may from time to time revoke and discharge any such committee of the Board either wholly or in part and either as to persons or purposes, but every committee of the Board so formed shall in the exercise of the powers so delegated conform to any regulations that may from time to time be imposed on it by the Board. All acts done by any such committee of the Board in conformity with such regulations and in fulfillment of the purposes of their appointment but not otherwise shall have the like force and effect as if done by the Board.	<b>DIRECTORS MAY APPOINT COMMITTEE</b>
102.	No resolution shall be deemed to have been duly passed by the Board or by a committee thereof by circulation, unless the resolution has been circulated in draft, together with the necessary papers, if any, to all the directors, or members of the committee, as the case may be, at their addresses registered with the company in India by hand delivery or by post or by courier, or through such electronic means as may be prescribed and has been approved by a majority of the directors or members,	<b>RESOLUTIONS BY CIRCULATION</b>

<p>who are entitled to vote on the resolution. Company shall comply with provisions of Section 175 in this regard.</p>	<p><b>ACTS OF BOARD OR COMMITTEE VALID NOTWITHSTANDING INFORMAL APPOINTMENT</b></p>
<p>103. All acts done by any meeting of the Board or by a committee of the Board, or by any person acting, as a Director shall notwithstanding that it shall afterwards be discovered that there is some defect in the appointment of such Director or persons acting as aforesaid, or that they or any of them were disqualified or had vacated office or that the appointment of any of them had been terminated by virtue of any provisions contained in the Act or in these Articles, be as valid as if every such person had been duly appointed, and was qualified to be a Director and had not vacated his office or his appointment had not been terminated, provided that nothing in this Article shall be deemed to give validity to Acts done by a Director after his appointment has been shown to the Company to be invalid or to have terminated.</p>	
<p>104. i) The company shall cause minutes of all proceedings of every meeting of the Board and committee thereof to be kept by making within thirty days of the conclusion of every such meeting entries thereof in books kept for that purpose with their pages consecutively numbered.          ii) Each page of every such book shall be initialed or signed and the last page of the record of proceedings of every meeting in such books shall be dated and signed by the Chairman of the said meeting or the Chairman of the next succeeding meeting.          iii) In no case shall the minutes of proceedings of a meeting be attached to any such books as aforesaid by pasting or otherwise.          iv) The minutes of each meeting shall contain a fair and correct summary of the proceedings thereat.          v) All appointments of officers made at any of the meetings aforesaid shall be included in the minutes of the meetings.          vi) The minutes shall also contain:          a. the names of the Directors present at the meeting; and          b. in the case of each resolution passed at the meeting, the names of the Directors, if any, dissenting from or not concurring in the resolution.          vii) Nothing contained in sub-clauses (1) to (6) shall be deemed to require the inclusion in any such minutes of any matter which in the opinion of the Chairman of the meeting;          a. is or could reasonably be regarded as defamatory of any person.          b. is irrelevant or immaterial to the proceedings, or          c. is detrimental to the interests of the company The Chairman shall exercise an absolute discretion in regard to the inclusion or non-inclusion of any matter in minutes on the grounds specified in this sub clause.          viii) Minutes of meeting kept in accordance with aforesaid provisions shall be evidence of the proceedings recorded therein.</p>	<p><b>MINUTES OF PROCEEDINGS OF MEETINGS OF BOARD</b></p>
<p>105. The business of the Company shall be managed by the Directors who may exercise all such powers of the Company as are not, by the act or any statutory modification thereof for the time being in force, or by these Articles, required to be exercised by the Company in General Meeting, subject nevertheless to any regulation of this Articles, to the provisions of the said Act, and to such regulations being not inconsistent with the aforesaid regulations or provisions as may be prescribed by the Company in General Meeting; but no regulation made by the Company in General Meeting, shall invalidate any prior act of the Directors which would have been valid if that regulation had not been made.</p>	
<p>106. Without prejudice to the general powers conferred by the Article 105 and so as not in any way to limit or restrict those powers conferred by these Articles, but subject to the restrictions contained in the Article 105, it is hereby declared that the Directors shall have the following powers, that is to say, power:           1. To pay the costs, charges and expenses, preliminary and incidental to the promotion, formation, establishment and registration of the company.</p>	<p><b>CERTAIN POWERS OF THE BOARD</b></p>

2. To pay and charge to the capital account of the Company any commission or interest lawfully payable there out under the provisions of the Act.
3. Subject to the provisions of the Act to purchase or otherwise acquire for the Company any property, right or privileges which the Company is authorized to acquire at or for such price or consideration and generally on such terms and conditions as they may think fit, and in any such purchase or other acquisition to accept such title as the Directors may believe or may be advised to be reasonably satisfactory.
4. At their discretion and subject to the provisions of the Act to pay for any property, rights or privileges acquired by or services rendered to the Company either wholly or partially in cash or in shares, bonds, debentures, mortgages, or other securities of the Company, and any such shares may be issued either as fully paid-up or with such amount credited as paid-up thereon as may be agreed upon and any such bonds, debentures, mortgages or other securities may be either specifically charged upon all or any part of the property of the Company and its uncalled capital or not so charged.
5. To secure the fulfillment of any contracts or engagements entered into by the Company by mortgage or charge of all or any of the property of the Company and its uncalled capital for the time being or in such manner as they may think fit.
6. To accept from any member, as far as may be permissible by law, a surrender of his shares or any part thereof, on such terms and conditions as shall be agreed.
7. To appoint any person to accept and hold in trust for the Company any property belonging to the Company or in which it is interested, or for any other purpose, and to execute and do all such deeds and things as may be required in relation to any trust and to provide for the remuneration of such trustee or trustees.
8. To institute, conduct, defend, compound, or abandon any legal proceedings by or against the Company or its officers or otherwise concerning the affairs of the Company and also to compound and allow time for payment or satisfaction of any debts due and of any claim or demands by or against the Company and to refer any differences to arbitration and observe and perform any awards made thereon.
9. To act on behalf of the Company in all matters relating to bankrupts and insolvents.
10. To make and give receipts, releases and other discharges for moneys payable to the Company and for the claims and demands of the Company.
11. Subject to the provisions of the Act, to invest and deal with any moneys of the Company not immediately required for the purpose thereof upon such security (not being shares of this Company), or without security and in such manner as they may think fit and from time to time to vary or realize such investments, save as provided in 187 of the Act, all investments shall be made and held in the Company's own name.
12. To execute in the name and on behalf of the Company in favour of any Director or other person who may incur or be about to incur any personal liability, whether as principal or surety, for the benefit of the Company, such mortgage of the Company's property (present and future) as they think fit, and any such mortgage may contain a power of sale and such other powers, provisions, covenants and agreements as shall be agreed upon.
13. To determine from time to time who shall be entitled to sign, on the Company's behalf, bills, notes, receipts, acceptances, endorsements, cheques, dividend warrants, releases contracts and documents and to give the necessary authority for such purpose.

14. To distribute by way of bonus amongst the staff of the Company a share or shares in the profit of the Company and to give to any officer or other persons employed by the Company a commission on the profits of any particular business or transactions and to charge such bonus or commission as part of the working expenses of the Company.

15. To provide for the welfare of Directors or ex-Directors or ex-employees of the Company and their wives, widow and families or dependents or connections of such persons, by building or contributing to the building of houses, dwellings or chaws, or by grants of money, pension, gratuities, allowances, bonus or other payments, or by creating, and from time to time subscribing or contributing towards places of instructions and recreation, hospitals and dispensaries, medical and other attendance and other assistance, as the Board shall think fit, and to subscribe or contribute or otherwise to assist or to guarantee money to charitable, benevolent, religious, scientific, national or other institutions or objects which shall have any moral or other claim to support or aid by the company, either by reason of locality of operation, or of public and general utility or otherwise.

16. Before recommending any dividend, to set aside out of the profits of the Company, such sum as they may think proper for depreciation fund or to an insurance fund or as a reserve fund or sinking fund or any special fund to meet contingencies or to repay debentures or debenture-stock or for special dividends or for equalizing dividends or for repairing, improving, extending and maintaining any of the property of the Company and for such other purposes (including the purposes referred to in the preceding clause) as the Board may, in its absolute discretion think conducive to the interest of the Company and subject to the provisions of the Act to invest the several sums so set aside or so much thereof as required to be invested, upon such investments (other than shares of the Company) as they may think fit, and from time to time to deal with and vary such investments and dispose of and apply and expend all or any part thereof for the benefit of the Company, in such manner and for such purposes as the Board in their absolute discretion think conducive to the interest of the Company, notwithstanding that the matters to which the Board apply or upon which they expend the same or any part thereof may be matters to or upon which the capital moneys of the Company might rightly be applied or expended, and to divide the reserve fund into such special funds as the Board may think fit, with full power to transfer the whole or any portion of a reserve fund or division of a reserve fund to another reserve fund or division of a reserve fund and with full power to employ the assets constituting all or any of the funds including the depreciation of debentures or debenture-stock and without being bound to pay interest on the same with power, however, to the Board at its discretion to pay or allow to the credit of such funds interest at such rate as the Board may think proper, not exceeding nine per cent per annum.

17. To appoint, and at their discretion remove or suspend such general managers, managers, secretaries, assistants, supervisors, clerks, agents and servants for permanent, temporary or special services as they may from time to time think fit, and to determine their powers and duties and fix their salaries or emoluments or remuneration, and to require security in such instances and to such amount as they may think fit. And also from time to time to provide for the management and transaction of the affairs of the Company in any specified locality in India or elsewhere in such manner as they think fit; and the provisions contained in the four next following subclasses shall be without prejudice to the general powers conferred by this sub clause.

18. To comply with the requirements of any local law which in their opinion it shall in the interest of the Company be necessary or expedient to comply with.

19. From time to time and at any time to establish any local board for managing any of the affairs of the Company in any specified locality in India or elsewhere and to appoint any persons to be members of such local boards, and to fix their remuneration.

20. Subject to provisions of the Act, from time to time and at any time to delegate to any person so appointed any of the powers, authorities and discretion for the time being vested in the Board, other than their power to make call or to make loans or borrow moneys, and to authorize the members for the time being of any such local board, or any of them, to fill up any vacancies and any such appointment or delegation may be made on such terms and subject to such conditions as the Board may think fit, and the Board may at any time remove any person so appointed and may annul or vary any such delegation.

21. At any time and from time to time by power of attorney under the seal of the Company, to appoint, any person or persons to be the attorney or attorneys of the Company, for such purposes and with such powers, authorities and discretion (not exceeding those vested in or exercisable by the Board under these presents and excluding the power to make calls and excluding also except in their limits authorized by the Board the power to make loans and borrow moneys) and for such period and subject to such conditions as the Board may from time to time think fit; and any such appointment may (if the Board thinks fit) be made in favour of the members or any of the members of any local board, established as aforesaid or in favour of any company, or the shareholders, directors, nominee or managers, of any company or firm or otherwise in favour of any fluctuating body of persons whether nominated directly or indirectly by the Board and any such power of attorney may contain such powers of the protection or convenience of persons dealing with such attorneys as the Board may think fit, and may contain powers enabling any such delegates or attorneys as aforesaid to sub-delegate all or any of the powers, authorities and discretion for the time being vested in them.

22. Subject to the provisions of the Act, for or in relation to any of the matters aforesaid or otherwise for the purposes of the Company to enter into all such negotiations and contracts and rescind and vary all such contracts and execute and do all such acts, deed and things in the name and on behalf of the Company's they may consider expedient.

23. From time to time to make, vary and repeal bye-laws for the regulations of the business of the Company, its officers and servants.

---

107. The Directors may from time to time appoint, and at their discretion, remove the Secretary provided that where the paid-up capital of the Company is more than or equal to the limit prescribed under Section 203 of the Act read with the relevant rules made there under and as amended from time to time, it shall have a whole time secretary. The Directors may also at any time appoint some person (who need not be the secretary) to keep the registers required to be kept by the Company.

**THE SECRETARY**

---

108. a) The Board shall provide a common seal for the purpose of the Company, and shall have power from time to time to destroy the same and substitute a new seal in lieu thereof and the Board shall provide for the safe custody of the seal for the time being, and the seal shall never be used except by the authority of the Board or a Committee of the Board previously given.

**THE SEAL, ITS  
CUSTODY AND USE**

b) The company shall also be at liberty to have an official seal in accordance with of the provisions of the Act, for use in any territory, district or place outside India.

---

109.	Every deed or other instrument to which the seal of the Company is required to be affixed, shall unless the same is executed by a duly constituted attorney, be signed by two Directors or one Director and Secretary or some other person appointed by the Board for the purpose provided that in respect of the share certificate the seal shall be affixed in accordance with Articles hereof.	<b>DEEDS HOW EXECUTED</b>
110.	The Profits of the Company, subject to any special rights relating thereto created or authorized to be created by these Articles and subject to the provisions of these Articles and the Act shall be divisible among the members in proportion to the amount of capital paid or credited paid-up on the shares held by them respectively.	<b>DIVIDENDS DIVISIONS OF PROFITS</b>
111.	The company in General Meeting may declare dividends to be paid to members according to their respective rights, but no dividend shall exceed the amount recommended by the Board, but the Company in General Meeting may declare smaller dividend.	<b>THE COMPANY IN GENERAL MEETING MAY DECLARE A DIVIDEND</b>
112.	No dividend shall be declared or paid otherwise than out of profits of the financial year arrived at after providing for depreciation in accordance with the provisions of 123 of the Act or out of the profits of the Company for any previous financial year or years arrived at after providing for depreciation in accordance with these provisions and remaining undistributed or out of both provided that:  a) If the Company has not provided for depreciation for any previous financial year or years it shall, before declaring or paying a dividend for any financial year, provide for such depreciation out of the profits of the financial year or out of the profits of any other previous financial year or years;  b) If the Company has incurred any loss in any previous financial year or years the amount of the loss or an amount which is equal to the amount provided for depreciation for that year or those years whichever is less, shall be set off against the profits of the company for the year for which the dividend is proposed to be declared or paid or against the profits of the Company for any previous financial year or years arrived at in both cases after providing for depreciation in accordance with the provisions of 123 of the Act or against both.	<b>DIVIDENDS ONLY TO BE PAID OUT OF PROFITS</b>
113.	The Board may, from time to time, pay to the members such interim dividend as in their judgment the position of the Company justifies.	<b>INTERIM DIVIDEND</b>
114.	Where capital is paid in advance of calls, such capital may carry interest but shall not in respect thereof confer a right to dividend or participation in profits.	<b>CAPITAL PAID - UP IN ADVANCE AND INTEREST, NOT TO EARN DIVIDEND</b>
115.	All dividends shall be apportioned and paid proportionately to the amounts paid or credited as paid on the shares during any portion or portions of the period in respect of which the dividend is paid, but if any share is issued on terms providing that it shall rank for dividend as from a particular date, such share shall rank for dividend accordingly.	<b>DIVIDENDS IN PROPORTION TO AMOUNT PAID-UP</b>
116.	A transfer of shares shall not pass the right to any dividend declared thereon before the registration of the transfer.	<b>TRANSFER OF SHARE MUST BE REGISTERED</b>
117.	Unless otherwise directed any dividend may be paid by cheques or warrant or by a pay slip or receipt having the force of a cheque or warrant sent through the post to the registered address of the member or person entitled or in case of joint holders to that one of them first named in the register in respect of the joint holding. Every such cheque or warrant or pay slip or receipt lost in transmission, or for any dividend lost to the member or persons entitled thereto by the forged endorsement of any cheque or warrant or the forged signature of any pay slip or receipt or the fraudulent recovery of the dividend by any other means.	<b>DIVIDENDS HOW REMITTED</b>



118.	Subject to the provisions of 123 to 127 of the Act, no unpaid dividend shall bear interest as against the Company.	<b>INTEREST ON UNPAID DIVIDEND</b>
119.	No unclaimed dividend shall be forfeited by the Board unless the claim barred by law and the dividends unclaimed will be dealt with in accordance with the provisions of 123, 124 or other provisions, if any of the Act as may be applicable from time to time.	<b>UNCLAIMED DIVIDEND</b>
120.	Any General Meeting declaring a dividend may on the recommendation of the Directors make a call on the members of such amount as the meeting fixes, but so that the call on each member shall not exceed the dividend payable to him and so that the call be made payable at the same time as the dividend may, if so arranged between the Company and the member, be set off against the calls.	<b>DIVIDEND AND CALL TOGETHER</b>
121.	<p>a) The Company in General Meeting may resolve that any moneys, investments or other assets forming part of the undivided profits of the Company standing to the credit of the reserve fund, or any Capital Redemption Reserve Accounts, or in the hands of the Company and available for dividend (or representing premium received on the issue of shares and standing to the credit of the Share Premium Account) be capitalized and distributed amongst such of the shareholders as would be entitled to receive the same if distributed by way of dividend and in the same proportions on the footing that they become entitled thereto as capital and that all or any part of such capitalized fund be applied on behalf of such shareholders in paying up in full either at par or at such premium as the resolution may provide, any unissued shares of the Company which shall be distributed accordingly or in or towards payment of the uncalled liability on any issued shares and that such distribution or payment shall be accepted by such shareholders in full satisfaction of their interest in the said capitalized sum provided that a Share Premium Account and Capital Redemption reserve account may, for the purpose of this Article, only be applied in the paying of any unissued shares to be issued to members of the Company as fully paid bonus share.</p> <p>b) A General Meeting may resolve that any surplus money arising from the realization of any capital assets of the Company or any investment representing the same or any other undistributed profits of the Company not subject to charge for income-tax be distributed among the members on the footing that they receive the same as capital.</p> <p>c) For the purpose of giving effect to any resolution under the preceding paragraphs of this Articles the Board may settle any difficulty which may arise in regard to the distribution as it thinks expedient and in particular may issue fractional certificates.</p>	<b>CAPITALISATION</b>
122.	<p>The Company shall keep at the office or at such other place in India as the Board thinks fit, proper books of accounts in accordance with Section 128 of the Act with respect to:</p> <p>a) All sums of money received and expended by the Company and the matters in respect of which the receipts and expenditures take place;</p> <p>b) All sales and purchases of goods by the Company.</p> <p>c) The assets and liabilities of the Company.</p>	<b>ACCOUNTS</b> <b>DIRECTORS TO KEEP TRUE ACCOUNTS</b>
123.	Where the Board decides to keep all or any of the books of accounts at any place other than the office of the Company, the Company shall within seven days of the decision file with the Registrar a notice in writing giving the full address of that other place. The Company shall preserve in good order the books of account relating to a period of not less than eight years preceding the current year together with the vouchers relevant to any entry in such books of account. Where the Company has a branch office, whether in or outside India, the Company shall be deemed to have complied with this Article if proper books of account relating to the transactions effected at the branch office and proper summarized returns, made up-to-date at	<b>ACCOUNTS</b>

	intervals of not more than three months, are sent by the branch office to the Company at its office or other place in India, at which the Company's books of account are kept as aforesaid. The books of accounts shall give a true and fair view of the state of affairs of the Company or branch office as the case may be, and explain its transactions. The books of accounts and other books and papers shall be open to inspection by any Director during business hours.	
124.	The Board shall from time to time determine whether and to what extent and at what times and places and under what conditions or regulations the accounts and books of the Company or any of them shall be open to the inspection of members not being directors and no member (not being a Director) shall have any right of inspecting any account or books or documents of the Company except as conferred by law or authorized by the Board.	<b>INSPECTION OF ACCOUNTS OR BOOKS BY MEMBERS</b>
125.	The Directors shall from time to time, in accordance with Sections 129, 133, 134 and other provisions of the Act cause to be prepared and to be laid before the Company in General Meeting, such Financial Statements and other reports as are required by the Act.	<b>STATEMENT OF ACCOUNTS TO BE FURNISHED TO GENERAL MEETING</b>
126.	<p>a) A copy of every such financial statement (including the Auditors' Report and every other documents required by law to be annexed or attached to them), shall at least twenty one days before the meeting at which the same are to be laid before the members be sent to the members of the company, to holders of debentures issued by the Company (not being debentures which ecstatic are payable to the bearer thereof), to trustees for the holders of such debentures and to all persons entitled to receive notice of General Meeting of the Company.</p> <p>b) Without prejudice to the generality of the above provisions the company may; if its shares are listed at any recognized Stock Exchange make available for inspection at its registered office for a period not exceeding twenty one days before the date of the meeting and send a statement containing the salient features of such documents in the prescribed forms or copies thereof as the Company may deem fit to every member of the Company and to every trustee for the holder of any debenture issued by the Company not less than 21 days before the date of the meeting.</p>	<b>COPIES SHALL BE SENT TO EACH MEMBER</b>
127.	Every financial statement of the Company when audited and approved by the Company at an Annual General Meeting shall be conclusive except as regards any error discovered therein. Whenever any such error is discovered the financial statement shall forthwith be corrected by the Board and henceforth shall be conclusive.	<b>AUDITED AND APPROVED FINANCIAL STATEMENT TO BE CONCLUSIVE EVIDENCE</b>
128.	Auditors shall be appointed and their rights and duties regulated in accordance with Sections 139 to 143, and 145 to 148 of the Act.	<b>AUDIT</b>
129.	The Liquidator on any winding-up (whether voluntary, under supervision of the Court of compulsory) may, with the sanction of Special Resolution, but subject to the rights attached to any preference share capital, divide among the contributories in specie any part of the assets of the Company and may with the like sanction, vest any part of the assets of the Company in trustees upon such trusts for the benefit of the contributories as the liquidator, with the like sanction shall think fit.	<b>ACCOUNTS TO BE AUDITED</b> <b>WINDING UP</b> <b>LIQUIDATOR MAY DIVIDE ASSETS IN SPECIE</b>
130.	Subject to Section of the Act, every officer or agent for the time being of the Company shall be indemnified out of the assets of the Company, against all liability incurred by him in defending any proceedings, whether civil or criminal, in which judgment is given in his favour or in which he is acquitted or discharged or in connection with any application under Section 463 of the Act in which relief is granted to him by the Company.	<b>INDEMNITY AND RESPONSIBILITY</b> <b>DIRECTORS AND OTHERS RIGHT OF INDEMNITY</b>

131. a) Every Director, (except institution/ex-officio director) Auditor, Trustee, member of a committee, officer, servant, agent, accountant or other person employed in the business of the Company shall, if so required by the Directors before entering upon his duties, sign a declaration pledging himself to observe strict secrecy respecting all transactions and affairs of the Company and all matters relating thereto, and shall by such declaration pledge himself not to reveal any of the matters which may come to his knowledge in the discharge of his duties except when required to do so by the Directors or by law or by the person to whom such matters relate and except so far as may be necessary in order to comply with any of the provisions in these presents contained.

**SECURITY CLAUSE**

b) No member shall be entitled to visit or inspect any works of the Company, without the permission of the directors or to require discovery of or any information respecting any details of the Company's trading or any matter which is or may be in the nature of a trade secret, mystery of trade, secret process or any other matter which may relate to the conduct of the business of the Company and which, in the opinion of the Director, it would be inexpedient in the interest of the Company to disclose.

132. A. Any Director or Member or person can inspect the statutory registers maintained by the company, which may be available for inspection of such Director or Member or person under provisions of the act by the company, provided he gives fifteen days notice to the company about his intention to do so.

**REGISTERS,  
INSPECTION AND  
COPIES THEREOF**

B. Any, Director or Member or person can take copies of such registers of the company by paying Rs. 10 per page to the company. The company will take steps to provide the copies of registers to such person within Fifteen days of receipt of money.

133. Wherever in the applicable provisions under the Act, it has been provided that, any Company shall have any right, authority or that such Company could carry out any transaction only if the Company is authorized by its Articles, this regulation hereby authorizes and empowers the Company to have such right, privilege or authority and to carry out such transaction as have been permitted by the Act without there being any specific regulation or clause in that behalf in this articles.

**GENERAL  
AUTHORITY**

## SECTION IX – OTHER INFORMATION

### MATERIAL CONTRACTS AND DOCUMENTS FOR INSPECTION

The following contracts (not being contracts entered into in the ordinary course of business carried on by the Company or entered into more than two years before the date of the Prospectus) which are or may be deemed material have been entered or to be entered into by the Company. These contracts, copies of which have been attached to the copy of the Prospectus, delivered to the Registrar of Companies Rajasthan, Jaipur for registration. Copies of contracts and documents for inspection referred to hereunder, may be inspected at the registered office of the Company from 11.00 a.m. to 5.00 p.m. on working days from the date of the Prospectus until the Offer Closing Date.

#### Material Contracts

1. Agreement dated December 20, 2016 between our Company, Selling Shareholders and Hem Securities Limited as Lead Manager (LM) to the Offer.
2. Agreement dated December 20, 2016 executed between our Company, Selling Shareholders and the Registrar to the Offer (Link Intime India Pvt. Ltd.)
3. Market Making Agreement dated January 31, 2017 between our Company, the LM and Market Maker.
4. Banker to the Offer Agreement dated January 31, 2017 among our Company, the LM, Banker to the Offer and the Registrar to the Offer.
5. Underwriting Agreement dated January 31, 2017 between our Company, Selling Shareholders, the LM and Underwriter.
6. Share Escrow Agreement dated January 31, 2017 among our Company, the Selling Shareholders, the LM and Escrow Agent.
7. Tripartite Agreement dated January 14, 2017 among CDSL, the Company and the Registrar to the Offer.
8. Tripartite Agreement dated January 25, 2017 among NDSL, the Company and the Registrar to the Offer.

#### Material Documents

1. Certified copies of the Memorandum of Association and Articles of Association of our Company as amended.
2. Certificate of Incorporation dated May 14, 2004 issued by the Registrar of Companies, Rajasthan, Jaipur.
3. Certificate of Commencement dated issued by the Registrar of Companies, Rajasthan, Jaipur dated July 20, 2004 upon incorporation.
4. Copy of the Board Resolution dated December 14, 2016 authorizing the Offer and other related matters.
5. Copy of Shareholder's Resolution dated December 19, 2016 authorizing the Offer and other related matters.
6. Copies of the Authority letters/Board Resolution provided by the Selling Shareholders.
7. Copies of Audited Financial Statements of our Company for the period ended November 30, 2016 and years ended March 31, 2016, 2015, 2014, 2013 & 2012.
8. Peer Review Auditors Report dated December 26, 2016 on Restated Financial Statements of our Company for the period ended November 30, 2016 and years ended March 31, 2016, 2015, 2014, 2013 & 2012
9. Copy of the Statement of Tax Benefits dated December 22, 2016 from the Statutory Auditor.
10. Consents of the Lead Manager, Legal Advisor to the Offer, Registrar to the Offer, Market Maker, Underwriter, Banker to the Offer, Statutory Auditor of the Company, Peer Review Auditor, Promoters of our Company, Directors of our Company, Company Secretary and Compliance Officer, Chief Financial Officer, Bankers to our Company, as referred to, in their respective capacities.
11. Copy of Certificate from the Peer Review Auditors of our Company, M/s Ravi Mansaka & Associates, Chartered Accountants, dated December 26, 2016 regarding the Eligibility of the Offer.
12. Board Resolution dated December 29, 2016 for approval of Draft Prospectus and dated February 06, 2017 for approval Prospectus.
13. Due Diligence Certificate from Lead Manager dated December 29, 2016 filed with NSE and dated February 06, 2017 filed with SEBI.
14. Approval from NSE vide letter dated January 25, 2017 to use the name of NSE in this Draft Prospectus and Prospectus for listing of Equity Shares on the SME Platform of the NSE.

**DECLARATION**

I, the person mentioned herein below, as the Selling Shareholder, certify that all relevant provisions of the Companies Act, 2013, the Companies Act, 1956, to the extent applicable, the guidelines issued by the Government of India and the regulations and guidelines issued by Securities and Exchange Board of India established under section 3 of the Securities and Exchange Board of India Act, 1992, as the case may be, have been complied with while issuing the Prospectus. No statement made in the Prospectus is contrary to the provisions of the Companies Act, 2013, the Companies Act, 1956, to the extent applicable and the Securities and Exchange Board of India Act, 1992, each as amended from time to time or the rules made there under or regulations and guidelines issued, as the case may be. I further certify that all the statements made in the Prospectus are true and correct.

**SIGNED BY THE SELLING SHAREHOLDER:**

Sd/-

\_\_\_\_\_ **Mr. Pankaj Ostwal**

**Place: - Bhilwara**

**Date:- 06.02.2017**

**DECLARATION**

I, the person mentioned herein below, as the Selling Shareholder, certify that all relevant provisions of the Companies Act, 2013, the Companies Act, 1956, to the extent applicable, the guidelines issued by the Government of India and the regulations and guidelines issued by Securities and Exchange Board of India established under section 3 of the Securities and Exchange Board of India Act, 1992, as the case may be, have been complied with while issuing the Prospectus. No statement made in the Prospectus is contrary to the provisions of the Companies Act, 2013, the Companies Act, 1956, to the extent applicable and the Securities and Exchange Board of India Act, 1992, each as amended from time to time or the rules made there under or regulations and guidelines issued, as the case may be. I further certify that all the statements made in the Prospectus are true and correct.

**SIGNED BY THE SELLING SHAREHOLDER:**

Sd/-

\_\_\_\_\_

**Mrs. Nitu Ostwal**

**Place: - Bhilwara**

**Date:- 06.02.2017**

**DECLARATION**

I, the person mentioned herein below, as the Selling Shareholder, certify that all relevant provisions of the Companies Act, 2013, the Companies Act, 1956, to the extent applicable, the guidelines issued by the Government of India and the regulations and guidelines issued by Securities and Exchange Board of India established under section 3 of the Securities and Exchange Board of India Act, 1992, as the case may be, have been complied with while issuing the Prospectus. No statement made in the Prospectus is contrary to the provisions of the Companies Act, 2013, the Companies Act, 1956, to the extent applicable and the Securities and Exchange Board of India Act, 1992, each as amended from time to time or the rules made there under or regulations and guidelines issued, as the case may be. I further certify that all the statements made in the Prospectus are true and correct.

**SIGNED BY THE SELLING SHAREHOLDER:**

Sd/-

\_\_\_\_\_

**Mrs. Ekta Ostwal**

**Place: - Bhilwara**

**Date:- 06.02.2017**

**DECLARATION**

I, the person mentioned herein below, as the Selling Shareholder, certify that all relevant provisions of the Companies Act, 2013, the Companies Act, 1956, to the extent applicable, the guidelines issued by the Government of India and the regulations and guidelines issued by Securities and Exchange Board of India established under section 3 of the Securities and Exchange Board of India Act, 1992, as the case may be, have been complied with while issuing the Prospectus. No statement made in the Prospectus is contrary to the provisions of the Companies Act, 2013, the Companies Act, 1956, to the extent applicable and the Securities and Exchange Board of India Act, 1992, each as amended from time to time or the rules made there under or regulations and guidelines issued, as the case may be. I further certify that all the statements made in the Prospectus are true and correct.

**SIGNED BY FOR M/S MAHENDRA KUMAR OSTWAL HUF:**

Sd/-

\_\_\_\_\_

**Mr. Mahendra Kumar Ostwal  
Karta**

**Place: - Bhilwara**

**Date:- 06.02.2017**



**DECLARATION**

I, the person mentioned herein below, as the Selling Shareholder, certify that all relevant provisions of the Companies Act, 2013, the Companies Act, 1956, to the extent applicable, the guidelines issued by the Government of India and the regulations and guidelines issued by Securities and Exchange Board of India established under section 3 of the Securities and Exchange Board of India Act, 1992, as the case may be, have been complied with while issuing the Prospectus. No statement made in the Prospectus is contrary to the provisions of the Companies Act, 2013, the Companies Act, 1956, to the extent applicable and the Securities and Exchange Board of India Act, 1992, each as amended from time to time or the rules made there under or regulations and guidelines issued, as the case may be. I further certify that all the statements made in the Prospectus are true and correct.

**SIGNED BY FOR M/S PANKAJ OSTWAL HUF:**

Sd/-

\_\_\_\_\_

**Mr. Pankaj Ostwal  
Karta**

**Place: - Bhilwara**

**Date:- 06.02.2017**

**DECLARATION**

I, the person mentioned herein below, as the Selling Shareholder, certify that all relevant provisions of the Companies Act, 2013, the Companies Act, 1956, to the extent applicable, the guidelines issued by the Government of India and the regulations and guidelines issued by Securities and Exchange Board of India established under section 3 of the Securities and Exchange Board of India Act, 1992, as the case may be, have been complied with while issuing the Prospectus. No statement made in the Prospectus is contrary to the provisions of the Companies Act, 2013, the Companies Act, 1956, to the extent applicable and the Securities and Exchange Board of India Act, 1992, each as amended from time to time or the rules made there under or regulations and guidelines issued, as the case may be. I further certify that all the statements made in the Prospectus are true and correct.

**SIGNED BY FOR M/S PRAVEEN OSTWAL HUF:**

Sd/-

\_\_\_\_\_

**Mr. Praveen Ostwal  
Karta**

**Place: - Bhilwara**

**Date:- 06.02.2017**

**DECLARATION**

I, the person mentioned herein below, as the Selling Shareholder, certify that all relevant provisions of the Companies Act, 2013, the Companies Act, 1956, to the extent applicable, the guidelines issued by the Government of India and the regulations and guidelines issued by Securities and Exchange Board of India established under section 3 of the Securities and Exchange Board of India Act, 1992, as the case may be, have been complied with while issuing the Prospectus. No statement made in the Prospectus is contrary to the provisions of the Companies Act, 2013, the Companies Act, 1956, to the extent applicable and the Securities and Exchange Board of India Act, 1992, each as amended from time to time or the rules made there under or regulations and guidelines issued, as the case may be. I further certify that all the statements made in the Prospectus are true and correct.

**SIGNED BY THE SELLING SHAREHOLDER:**

Sd/-

\_\_\_\_\_ **Mr. Mahendra Kumar Ostwal**

**Place: - Bhilwara**

**Date:- 06.02.2017**

**DECLARATION**

I, the person mentioned herein below, as the Selling Shareholder, certify that all relevant provisions of the Companies Act, 2013, the Companies Act, 1956, to the extent applicable, the guidelines issued by the Government of India and the regulations and guidelines issued by Securities and Exchange Board of India established under section 3 of the Securities and Exchange Board of India Act, 1992, as the case may be, have been complied with while issuing the Prospectus. No statement made in the Prospectus is contrary to the provisions of the Companies Act, 2013, the Companies Act, 1956, to the extent applicable and the Securities and Exchange Board of India Act, 1992, each as amended from time to time or the rules made there under or regulations and guidelines issued, as the case may be. I further certify that all the statements made in the Prospectus are true and correct.

**SIGNED BY FOR MADHYA BHARAT AGRO PRODUCTS LIMITED:**

Sd/-

**Mr. Pankaj Ostwal**  
**Managing Director**  
**DIN:-02586806**

**Place: - Bhilwara**

**Date:- 06.02.2017**

**DECLARATION**

I, the person mentioned herein below, as the Selling Shareholder, certify that all relevant provisions of the Companies Act, 2013, the Companies Act, 1956, to the extent applicable, the guidelines issued by the Government of India and the regulations and guidelines issued by Securities and Exchange Board of India established under section 3 of the Securities and Exchange Board of India Act, 1992, as the case may be, have been complied with while issuing the Prospectus. No statement made in the Prospectus is contrary to the provisions of the Companies Act, 2013, the Companies Act, 1956, to the extent applicable and the Securities and Exchange Board of India Act, 1992, each as amended from time to time or the rules made there under or regulations and guidelines issued, as the case may be. I further certify that all the statements made in the Prospectus are true and correct.

**SIGNED BY FOR CHUNRI PRINTS PRIVATE LIMITED:**

Sd/-

**Mrs. Archana Dangi**  
**Director**  
**DIN: - 03510693**

**Place: - Bhilwara**

**Date:- 06.02.2017**

**DECLARATION**

I, the person mentioned herein below, as the Selling Shareholder, certify that all relevant provisions of the Companies Act, 2013, the Companies Act, 1956, to the extent applicable, the guidelines issued by the Government of India and the regulations and guidelines issued by Securities and Exchange Board of India established under section 3 of the Securities and Exchange Board of India Act, 1992, as the case may be, have been complied with while issuing the Prospectus. No statement made in the Prospectus is contrary to the provisions of the Companies Act, 2013, the Companies Act, 1956, to the extent applicable and the Securities and Exchange Board of India Act, 1992, each as amended from time to time or the rules made there under or regulations and guidelines issued, as the case may be. I further certify that all the statements made in the Prospectus are true and correct.

**SIGNED BY FOR ARCHID PRODUCTS PRIVATE LIMITED:**

Sd/-

\_\_\_\_\_

**Mrs. Archana Dangi**  
**Director**  
**DIN: - 03510693**

**Place: - Bhilwara**

**Date:- 06.02.2017**

**DECLARATION**

I, the person mentioned herein below, as the Selling Shareholder, certify that all relevant provisions of the Companies Act, 2013, the Companies Act, 1956, to the extent applicable, the guidelines issued by the Government of India and the regulations and guidelines issued by Securities and Exchange Board of India established under section 3 of the Securities and Exchange Board of India Act, 1992, as the case may be, have been complied with while issuing the Prospectus. No statement made in the Prospectus is contrary to the provisions of the Companies Act, 2013, the Companies Act, 1956, to the extent applicable and the Securities and Exchange Board of India Act, 1992, each as amended from time to time or the rules made there under or regulations and guidelines issued, as the case may be. I further certify that all the statements made in the Prospectus are true and correct.

**SIGNED BY FOR PANERI TEXTILES PRIVATE LIMITED:**

Sd/-

\_\_\_\_\_

**Ms. Garima Dangi**  
**Director**  
**DIN: - 03602730**

**Place: - Bhilwara**

**Date:- 06.02.2017**

**DECLARATION**

I, the person mentioned herein below, as the Selling Shareholder, certify that all relevant provisions of the Companies Act, 2013, the Companies Act, 1956, to the extent applicable, the guidelines issued by the Government of India and the regulations and guidelines issued by Securities and Exchange Board of India established under section 3 of the Securities and Exchange Board of India Act, 1992, as the case may be, have been complied with while issuing the Prospectus. No statement made in the Prospectus is contrary to the provisions of the Companies Act, 2013, the Companies Act, 1956, to the extent applicable and the Securities and Exchange Board of India Act, 1992, each as amended from time to time or the rules made there under or regulations and guidelines issued, as the case may be. I further certify that all the statements made in the Prospectus are true and correct.

**SIGNED BY FOR SEASONS AGRO CHEM INDIA PRIVATE LIMITED:**

Sd/-

\_\_\_\_\_

**Mrs. Ekta Jain**  
**Director**  
**DIN: - 00412561**

**Place: - Bhilwara**

**Date:- 06.02.2017**



**DECLARATION**

We, the persons mentioned herein below, as Directors or otherwise, as mentioned, certify that all relevant provisions of the Companies Act, 2013, the Companies Act, 1956, to the extent applicable, the guidelines issued by the Government of India and the regulations and guidelines issued by Securities and Exchange Board of India established under section 3 of the Securities and Exchange Board of India Act, 1992, as the case may be, have been complied with while issuing the Prospectus. No statement made in the Prospectus is contrary to the provisions of the Companies Act, 2013, the Companies Act, 1956, to the extent applicable and the Securities and Exchange Board of India Act, 1992, each as amended from time to time or the rules made there under or regulations and guidelines issued, as the case may be. We further certify that all the statements made in the Prospectus are true and correct.

**SIGNED BY THE DIRECTORS OF OUR COMPANY:**

Sd/- \_\_\_\_\_ **Mr. Praveen Ostwal**  
*Chairman & Managing Director*  
 DIN: 00412207

Sd/- \_\_\_\_\_ **Mr. Sunil Kothari**  
*Whole- Time Director*  
 DIN: 02056569

Sd/- \_\_\_\_\_ **Mr. Ashish Kothari**  
*Non Executive Independent Director*  
 DIN: 06411429

Sd/- \_\_\_\_\_ **Mr. Pradeep Agarwal**  
*Non Executive Independent Director*  
 DIN: 06458531

Sd/- \_\_\_\_\_ **Mrs. Priyanka Surana**  
*Non Executive Independent Director*  
 DIN: 07679675

**SIGNED BY THE COMPANY SECRETARY & CHIEF FINANCIAL OFFICER OF OUR COMPANY:-**

Sd/- \_\_\_\_\_ **Ms. Priyanka Bansal**  
*Company Secretary & Compliance officer*

Sd/- \_\_\_\_\_ **Mr. Sunil Kothari**  
*Chief Financial Officer*

**Place: Bhilwara**

**Date: 06.02.2017**